



PT5E-0406

RIKEN PHOTOELECTRON SPECTROMETER

AC - 3

INSTRUCTION MANUAL

RIKEN KEIKI Co., Ltd.

2-7-6 Azusawa, Itabashi-ku, Tokyo, 174-8744, Japan

Phone : +81-3-3966-1113

Fax : +81-3-3558-9110

E-mail : intdept@rikenkeiki.co.jp

Web site : <https://www.rikenkeiki.co.jp/>

TABLE OF CONTENTS

1. In the beginning	2
1-1. Operational purpose	2
1-2. Caution for the safety	3
2. Precautions on operation	4
2-1. Danger items	4
2-2. Warning items	5
2-3. Caution items	7
3. Product functions	8
3-1. Designations	8
3-2. Name of each part and functions	13
3-3. Block diagram for nitrogen gas tubing	15
4. Installation	18
4-1. Cautions for transportation and installation	18
4-2. Cable connection	18
4-3. Compressed air tubing	19
4-4. Nitrogen gas tubing	19
5. Operation method	20
5-1. Check items	20
5-2. Connection of power source	20
5-3. Power on	21
5-4. Measurement	21
5-5. Readout the width of slit	22
5-6. Stopping the operation	23
6. Maintenance check	24
6-1. Daily check	24
6-2. Consumable parts	26
7. Measure at abnormal case	27
7-1. Self-diagnosis at trouble	27
7-2. Responding to the trouble	27
7-3. Before it is thought to be a trouble	28
8. Definition of terms	29
9. Measurement principle	30
9-1. Measurement principle of photo-election	30
9-2. Measurement of photo-election work function	31
10. List of product specification	32
10-1. Product specifications	32
10-2. Composition list	34

1. In the Beginning

It would be of our great pleasure to buy our PHOTOELECTRON SPECTROMETER “AC-3” this time. And it is requested to check by referring model number and this instruction manual.

The required items to do this operation correctly are described in this instruction manual. Then, read this manual fully even for well experienced customers who operated past as well as 1st time reader and customers, and your understanding of this matter would be much appreciated.

Then, it is kindly arranged that this INSTRUCTION MANUAL must be ready to reach to and is stored in easy place to get by end users it if required.

This manual is composed of followings. Read them to your necessity.

Title	Contents
AC-3 INSTRUCTION MANUAL	This is a instruction manual of AC-3. Operational procedures of AC-3 hardware are described.
AC-3 for Windows INSTRUCTION MANUAL (Measurement of work function and ionization potential)	Operation manual for Windows software. Measurement procedures for work function and ionization potential are described.
AC-3 Consumable parts replacement method	Replacement method for consumable parts is described.

✕It is strictly prohibited to copy or transcribe a part or whole of this manual without our prior approval.

1-1. Operational purpose

- This is designed to measure the photoelectron emission in air under normal temperature and normal pressure of solid state sample surface in the room of clean laboratory or fine instrument factory to be designed to generate the least emission of contamination on the material surface.
- The measurement of threshold energy photoelectron emission generated to radiate ultraviolet rays. (In most case, this threshold energy is interpreted as work function and ionization potential.)

1-2. Caution for the safety

The following headlines are used in this manual to work safety and effectively.



DANGER indicates an imminently hazardous situation which, if not avoided, will result in death or serious injury or serious damage to the product. This signal word is to be limited to the most extreme situation.



WARNING indicates a potentially hazardous situation which, if not avoided, could result in death or serious injury on the human body or object.



CAUTION indicates a potentially hazardous situation which, if not avoided, may result in minor or moderate injury or some damage on the human body or object. It may also be used to alert against unsafe practices.



This means “ADVICE” at operation

2. Precautions on operation

2-1. Danger item



- Do not install this instrument in a closed confined room. There is a danger to occur accident caused by oxygen deficiency if nitrogen gas would leak, since this instrument uses nitrogen gas on operation. Be sure to install the oxygen deficiency alarm in the operation room.
- Do not use this instrument without flowing nitrogen gas. If nitrogen gas is not flowed, it is danger that the ozone gas may be generated.

2-2. Warning items



- Do not open the cover while in operation.
 - There is the high voltage part inside, you may receive the electric shock.
 - As the ultraviolet rays are radiated from the lit-on lamp, do not see it by naked eyes absolutely. This may cause the pain of eye or difficulties of eyesight.
 - Do not illuminate ultraviolet rays directly to the skin. This may cause the inflammation of skin
 - As the lamp lit on or just after light-on is heated up, do not touch it by hand or skin. It may cause a burn.

- Abnormal heat, fume, abnormal sound and nasty smell.

If any abnormality should take place during operation, stop operation immediately, switch off the power and remove cable from the power socket. If continue to use, it may cause the electric shock and fire.
- Shock caused by transportation, dropping, impact and so on.

Do not give a shock more than 1G by transportation on movement, dropping, impact and so on.
- As this is composed of fine electronics parts, it may become far from normal operation and measurement.

- Operation at place with high temperature, humidity and plenty of dust
- Do not store or operate at high temperature, humidity and plenty of dust. It may cause trouble action., electric shock and fire. The operation shall be made at the given range of temperature and humidity.
- When desired to move from low temperature place to high temperature place, there is the case of dew inside or on the surface. The operation in such may cause the trouble. When move the product, leave it for some hours alone at the operation place and let it used to the ambient temperature.

- When use the deteriorated parts
- Check the pipeline and replace the appropriate parts regularly. When continue to use the deteriorated parts, it may cause breakage of pipe and exploded accident.
- The lamp which passes away life excessively may cause explosion.



▪ **Operation power**

Do not use other power voltage than the described. It may cause the breakage of product, electric shock and fire.

▪ **Connection of earth terminal (grounding)**

For safety, connect the power cable to electric outlet with earth (3P). When you use the accessory transducer plug, ground the earth terminal. If not grounded, it may cause the electric shock.

▪ **Handling of power cable**

- Do not put things on the power cable, pull in, push out, bend or slice. As power cable is damaged, it may cause electric shock and fire.
- When plug in and out the power cable into electric outlet, be sure to do it with power plug grasped. When pull the cable, a part may be disconnected and cause the fire.
- Check that there is no dust on the power plug and plug into electric outlet fully. Then do not use the loose electric outlet which may cause the contact failure. It may cause fire.
- When plug in the power cable, do not touch it by wet hand. It may cause the electric shock.
- Do not connect many cables into the same electric outlet. This may cause the fire and it may affect other product by power shutoff of breaker due to over use of power. This is subject to commercial power electric noise and may easily cause the trouble.

▪ **Intrusion of foreign substance**

Do not put other material than the measuring goods from the sample door. Also, do not enter the metal material or flammable material inside from the windows. When use as it is, it may cause the faulty action, electric shock and fire.

▪ **Put things onto the product**

Do not pull small metal goods such as pin, clip and container with water such as vane, plant. When they put inside and operate it as it is, it may cause the damage of products, the electric shock and fire.

2-3. Caution items



- Contact to the end surface of metal
When required to contact the end surface such as iron plate, enough attention and care should be taken so that any damage cannot take place.
- Do not use the Walky-talky near the product
When use the walky-talky etc which emits electric wave near the cable or product, there is the case that the correct measurement cannot be carried out and the attention for it would be required. When use such walky-talky etc, use it where there is no influence.
- Procedure of power on
Make power on after Operating System (OS) for Personal Computer is set up. If the power gets on before Operating System is set up, it may cause the error of operation.
- Power on again
When make power on again, wait more than 5 minutes after power off. When make power on within 5 minutes, there is the case that the normal operation cannot be carried out.
- Operation at the unstable place
Do not put it at the suitable place such as slant and vibrating place. It may not do the normal operation.
- The caution for compressed air
When the following material is contained in the compressed air, it may deteriorate the detector and dry air generating conditioner and there is possibility for damage.

Kind	Materials which should not contain
Solvent	Acetone, Benzene, Phenol, Toluene, Trichloroethylene, Xylene, Cresol, Thinner, Aniline, Chloroform, Alcohol, Dioxane, Tetrahydrofuran, Methylene chloride, Cyclohexanone, Carbon tetrachloride etc
Acid	Sulfuric acid, Nitric acid, Hydrochloric acid, Acetic acid, Lactic acid, Chromic acid etc
Gas	Chlorine, Sulfur dioxide, Hydrogen sulfide, Bromine, Semiconductor processing gas etc
Oil	Hydraulic fluid (Phosphatic Ester), Fuel oil, Water soluble cutting fluid(Alkaline), Kerosene etc

- When use at more than given pressure, it may damage the dry air generating system.
- When induct liquid such as water from the compressed air pipe, it may damage the system.
- When induct other gas such as N₂ gas, oxygen, inert gas than air from compressed air pipe, it may damage the system.

3. Product functions

3-1. Designations

3-1-1. Front panel

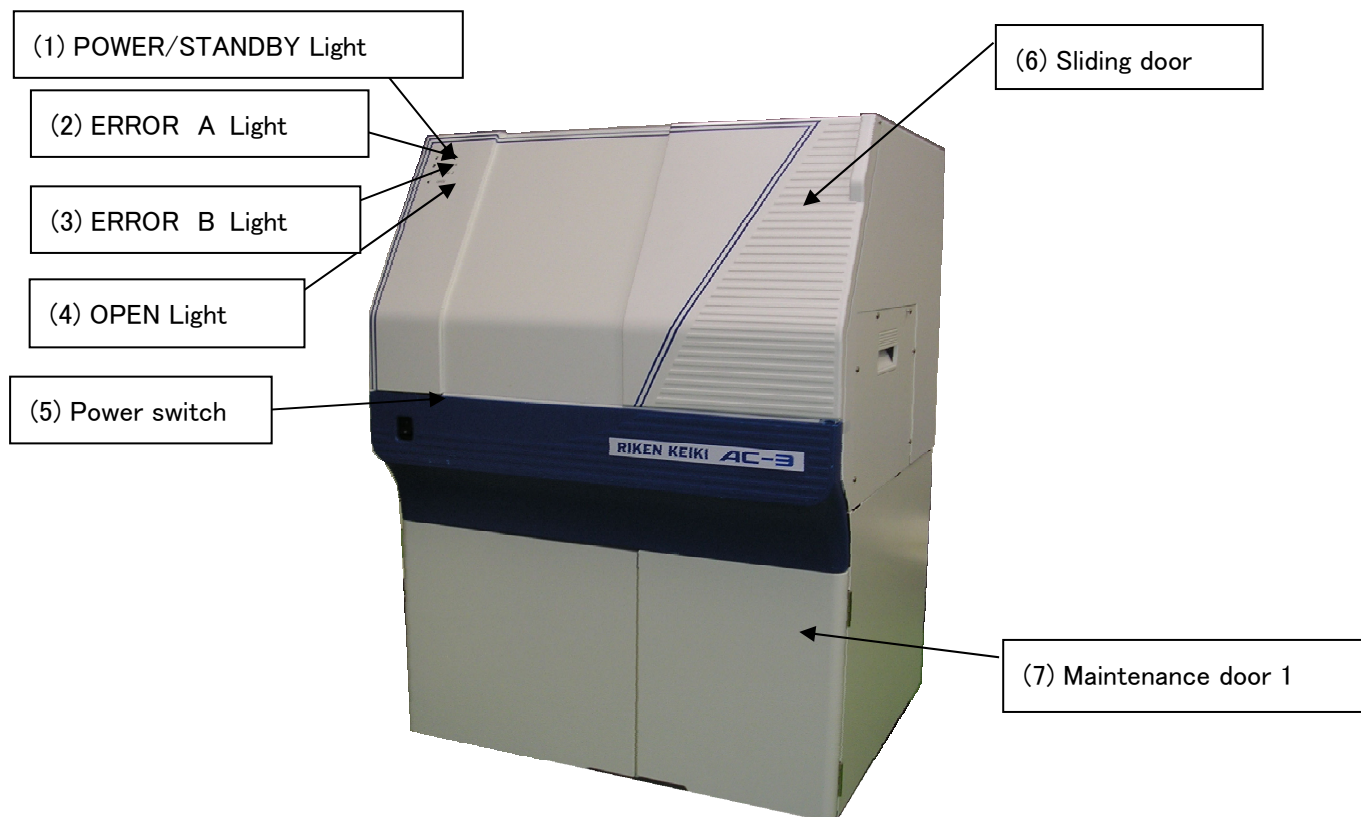

3-1-2. Sliding door inside

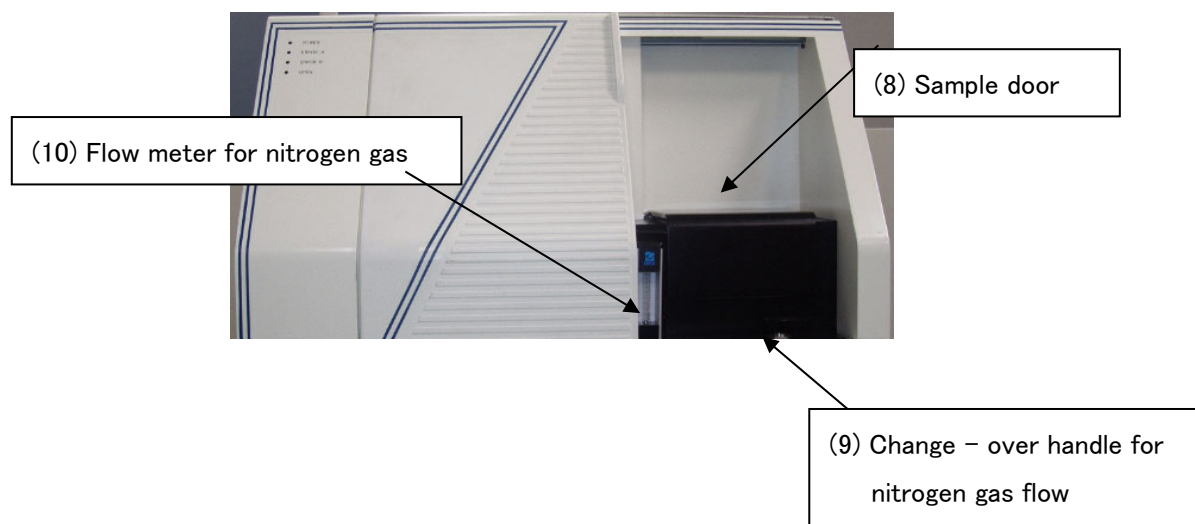

3-1-3. Sample door Inside

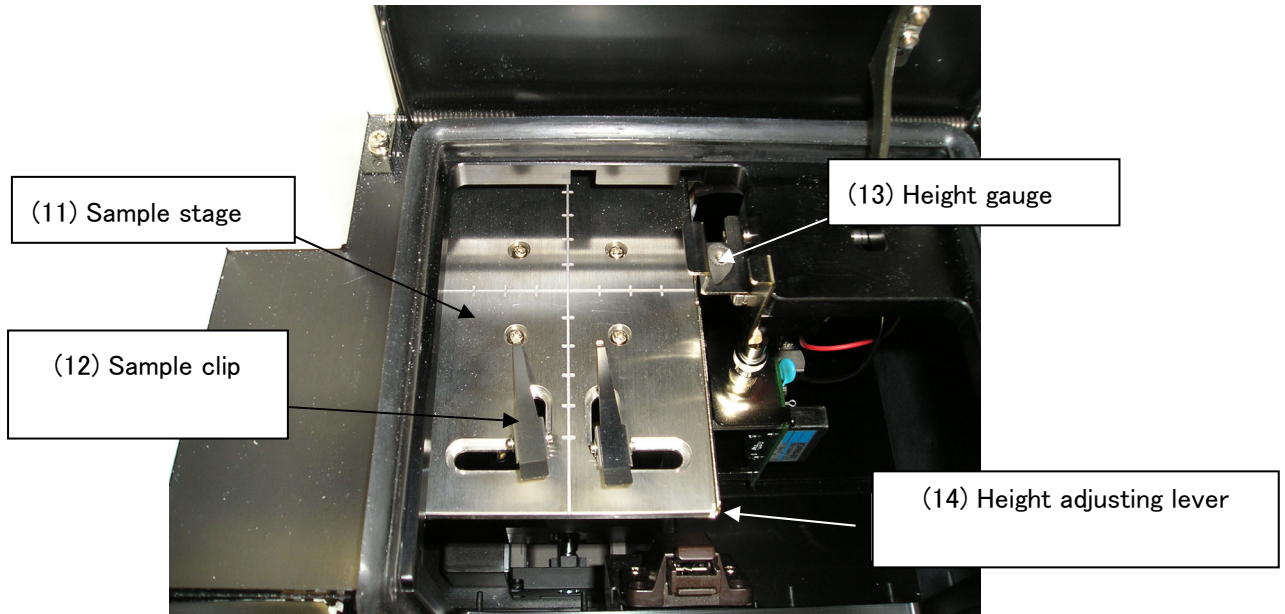

3-1-4. Maintenance door 1 Inside

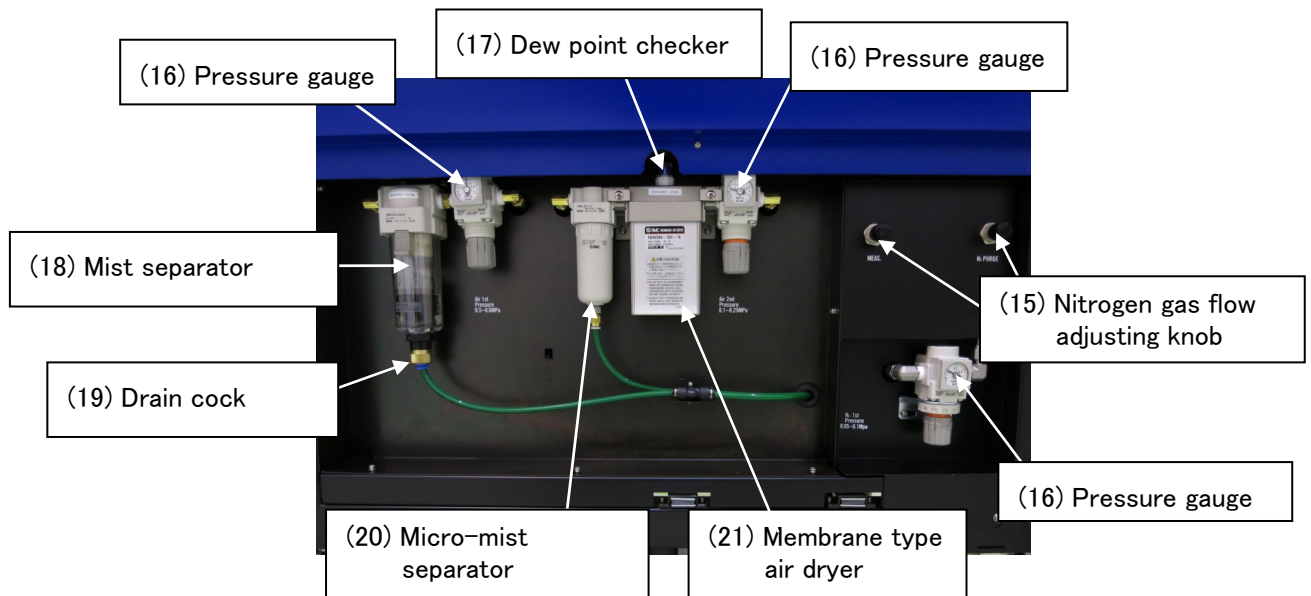

3-1-5. Rear panel

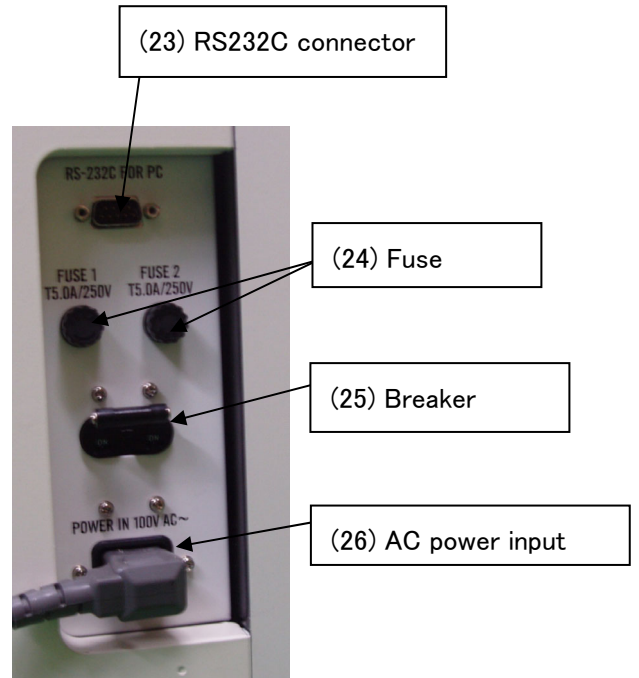
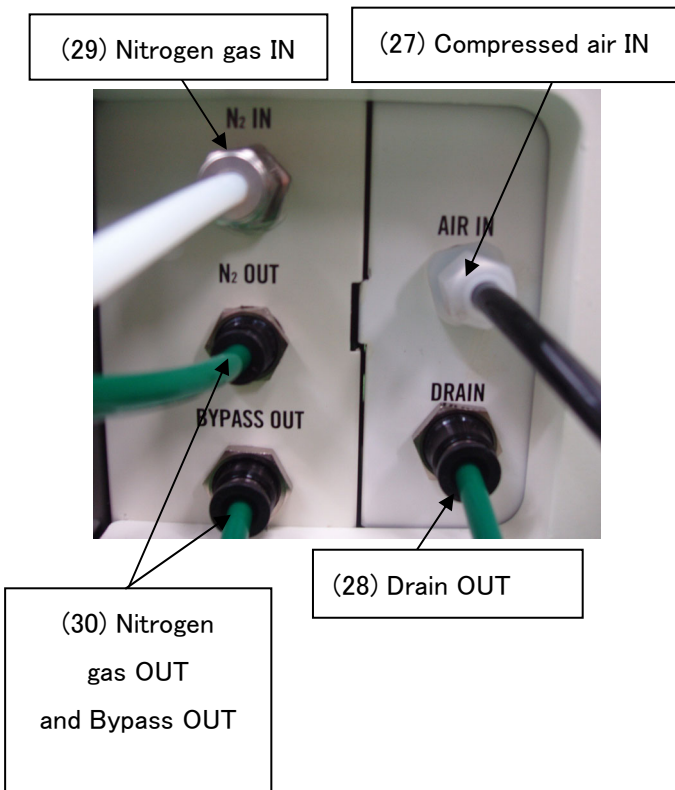
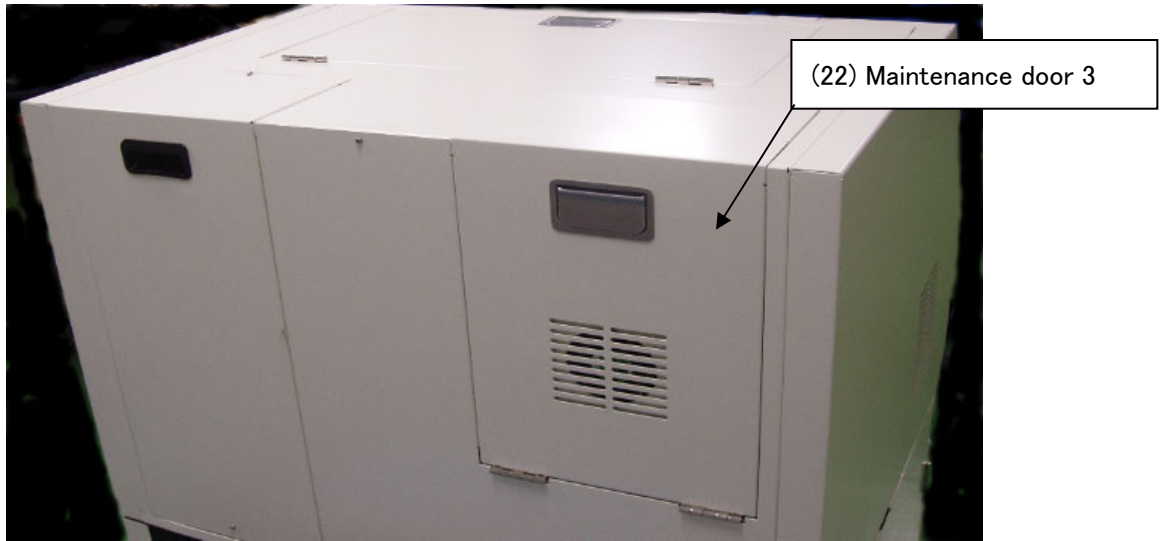

3-1-6. Upper panel

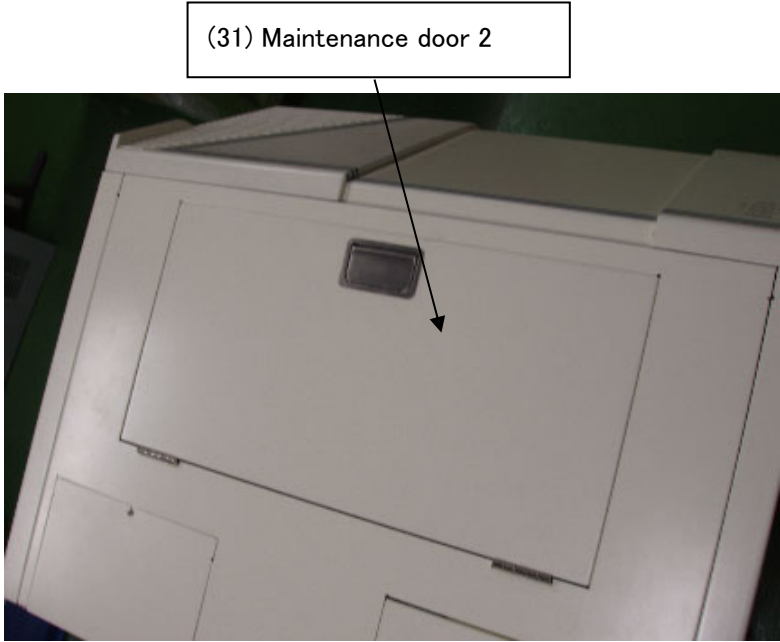

3-1-7. Maintenance door 2, inside

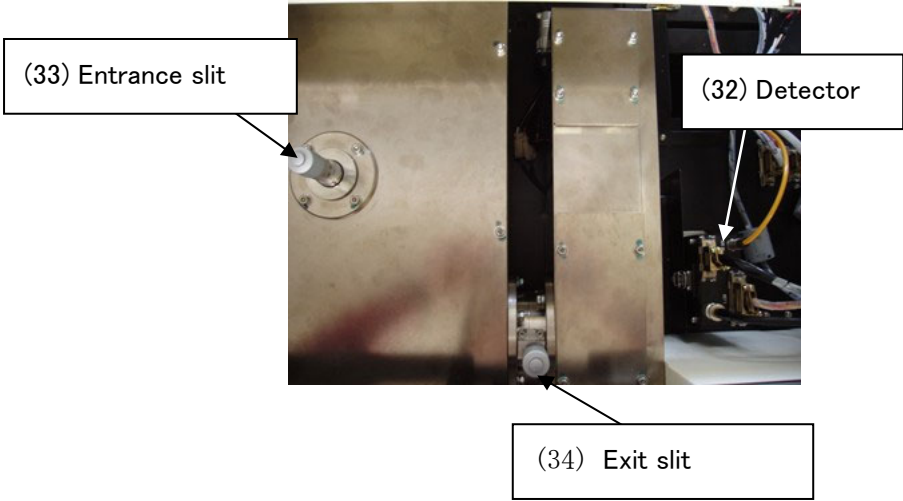

3-1-8. Side panel



3-1-9. Maintenance door 4, inside

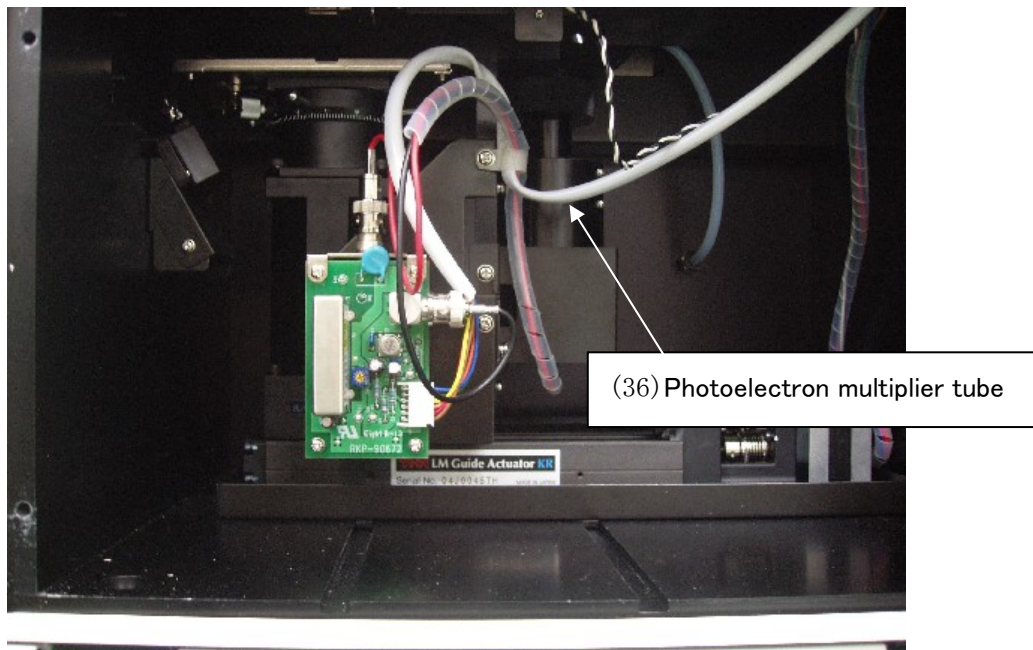

3-2. Name of each part and function

3-2-1. Front panel

- (1) POWER/STANDBY light : At measurement... Green light turns on.
At waiting (Warming up)... Green light flashes
- (2) ERROR "A" light : At initial power on/trouble... Red light flashes
(Light off at measuring condition)
- (3) ERROR "B" light : At initial power on/trouble... Red light flashes.
(Light off at measuring condition)
- (4) OPEN light : Orange light flashes when sample door is opened.
- (5) Power switch : ON (|), OFF (O)
- (6) Sliding door : Grip the handle and slide to the side to open the door.
- (7) Maintenance door 1

3-2-2. Sliding door, inside

- (8) Sample door : Push the upper surface to open measuring chamber.
- (9) Change-over handle for Nitrogen gas flow : Adjusts the Nitrogen gas flow.
- (10) Flow-meter for Nitrogen gas : Checks Nitrogen gas flow

3-2-3. Sample door, inside

- (11) Sample stage : Stage to put on the sample
- (12) Sample clip : Fixes the sample and makes the sample grounding
- (13) Height gauge : This gives height control standard of measuring surface.
- (14) Height adjusting lever : Changes the height of measuring surface

3-2-4. Sample door 1, inside

- (15) Nitrogen gas flow adjusting knob : To adjust Nitrogen gas flow.
- (16) Pressure gauge : Pressure gauge for compressed air.
- (17) Dew point checker : Checks dew point
- (18) Mist separator : Separates the moisture in gas
- (19) Drain cock : Cock to remove the drain
- (20) Micro-mist separator : Separates the moisture contained in the gas.
- (21) Membrane type air dryer : Removes the humidity contained in the gas.

3-2-5. Rear panel

- (22) Maintenance door 3 : UV lamp is installed inside this door
- (23) RS-232C connector : Port to connect PC
- (24) Fuse : 3A, 2 pieces
- (25) Breaker : This is for the main unit.
- (26) AC power input : To input the AC power source
- (27) Compressed air IN : Inlet for compressed air
- (28) Drain OUT : Drain outlet
- (29) Nitrogen gas IN : Inlet for Nitrogen gas
- (30) Nitrogen gas OUT and bypass OUT : Outlet for Nitrogen gas

3-2-6. Upper panel

- (31) Maintenance door 2

3-2-7. Maintenance door 2, Inside

- (32) Detector : Open counter
- (33) Entrance slit : To adjust the entrance slit
- (34) Exit slit : To adjust the exit slit

3-2-8. Side panel

- (35) Maintenance door 4

3-2-9. Maintenance door 4, inside

- (36) Photoelectron multiplier tube : Detects the photoelectron as electric current.

3-3. Block diagram

3-3-1. Electric line

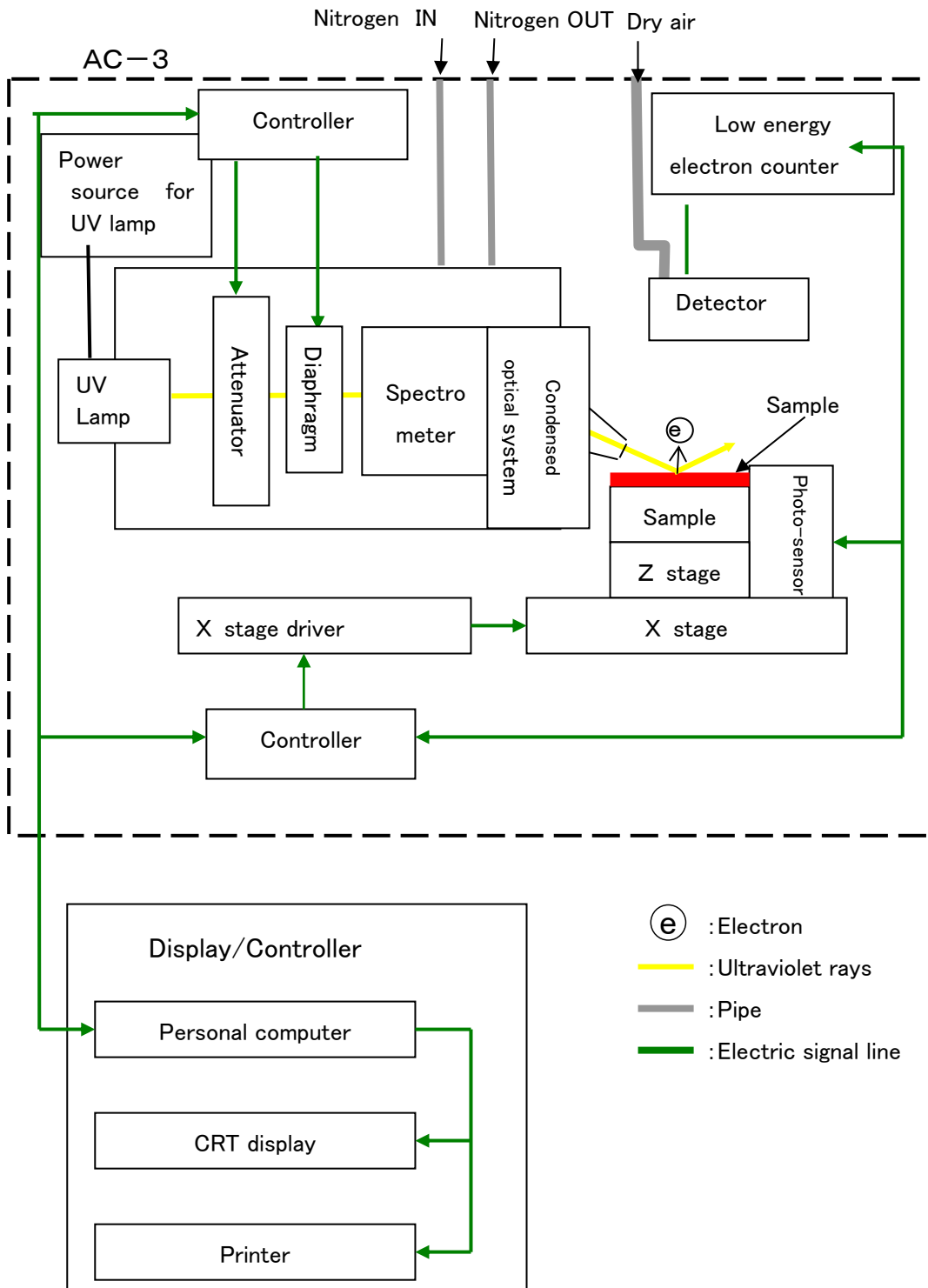

3-3-2. Compressed air tubing system

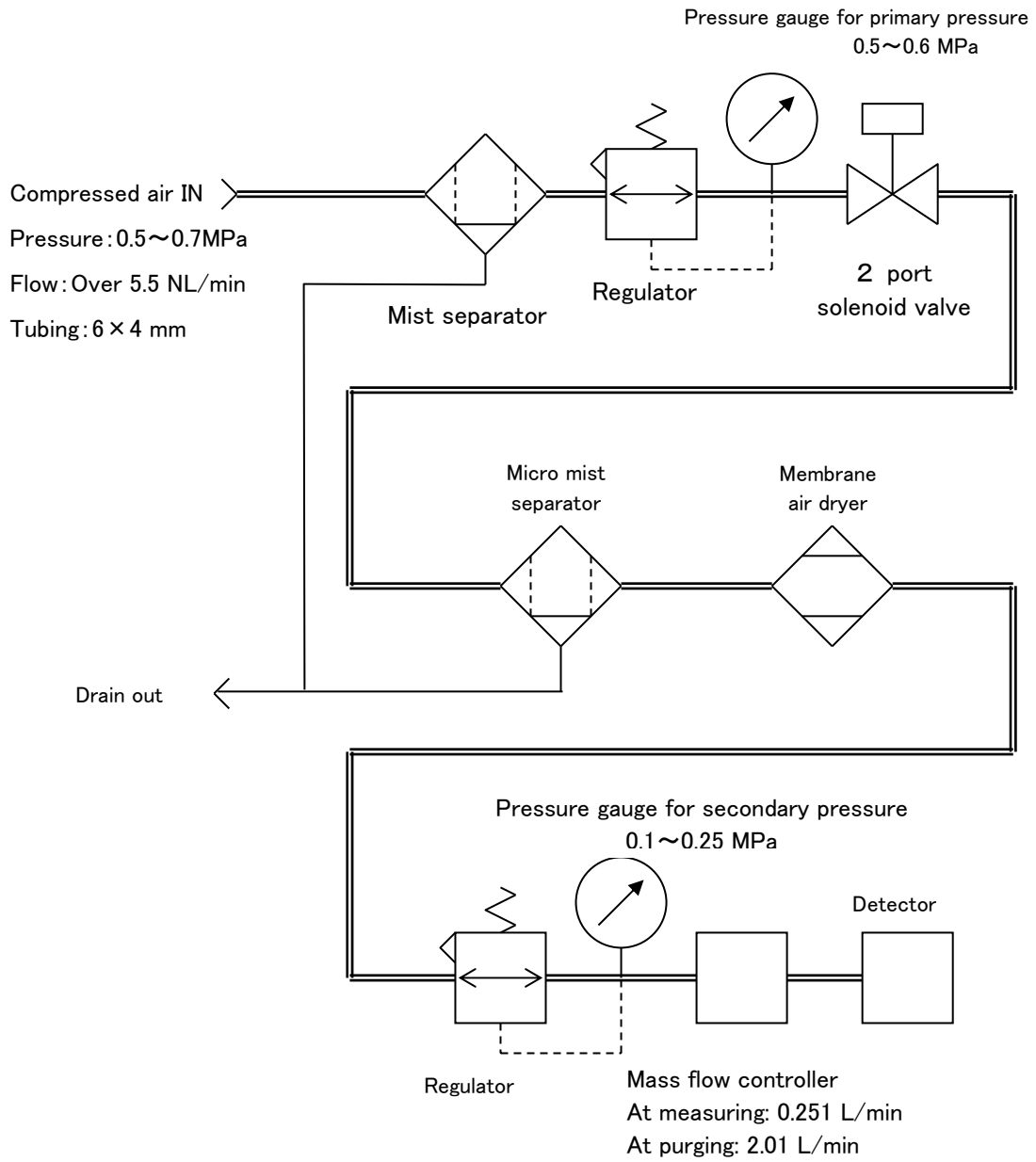

3-3-3. Block diagram for nitrogen gas tubing

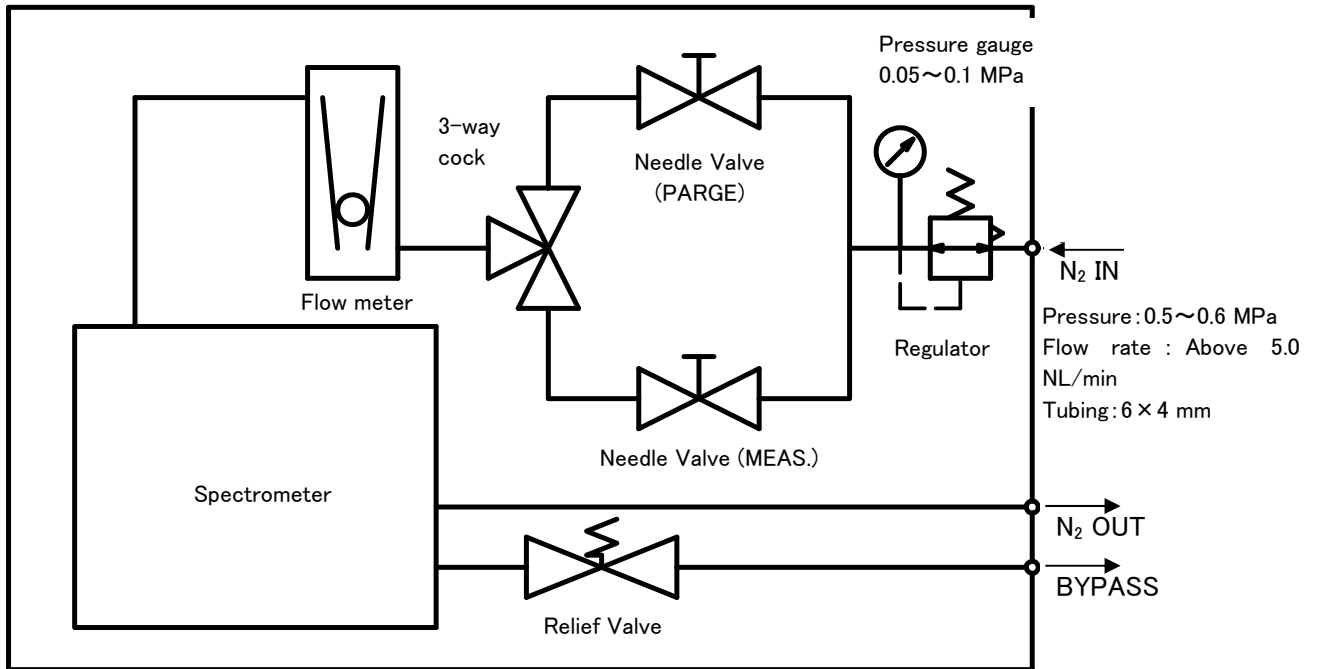

4. Installation

4-1. Caution for transportation and installation

- ① When transport, take care not to overload more than 1 G acceleration by vibration.
- ② Install this product on the floor.
- ③ Use this products inside of the room such as laboratory etc under stable temperature and humidity. Especially, the installation to the following place shall be requested to avoid. It may cause the trouble and accident.
 - Place outside of room and with water drops
 - Place full of dust and humidity
 - Place full of vibration
 - Drastic change place of temp and humidity. Direct sun-draught and vibration wind.
 - Place full of solvent, acid, alkaline vapors, much chemical floating.
- ④ As this is composed of fine electronics parts, do not drop or throw and mount it in stable and horizontal place.
- ⑤ Keep noise source from large capacity of transducer, motor, motive power and high voltage generator.
- ⑥ When use the walky-talky or hand-phone, put it at over 1m away from it to prevent the faulty operation by electric wave barrier.

4-2. Cable connection

- ① Connect this product and personal computer by RS cable (9 pin) supplied as accessory.
- ② Connect power cable to this product.

4—3. Compressed air tubing

- ① As tubing material, use the following nylon tube.
AIR IN side: Outer dia $\phi 6$ mm, Inner dia $\phi 4$ mm, Press resistance over 0.7MPa.
DRAIN OUT side: Outer dia $\phi 8$ mm, Inner $\phi 5$ mm, Press resistance over 0.3MPa.
- ② Check that the tube is cut vertically, the cross section is circle and there is no damage.
- ③ Check that the tube plugs into depth surely and cannot be pulled out after mounting .
- ④ Connect instrumentation air or compressed air (Pressure : 0.5~0.7MPa) to AIR IN side.
- ⑤ Tubing for drain OUT shall be led to the outside of this unit.



CAUTION

Water is discharged from DRAIN OUT. Exhaust to the outside so that the spherical instrument cannot be wet. At this time, to prevent advertent flow, it is arranged that water can run down.

4—4. Nitrogen gas tubing

- ① Use the stainless or PTFE tube for the IN side tubing.
Nitrogen gas IN side: Outer dia $\phi 6$ mm, Inner dia $\phi 4$ mm, Pressure resistance over 0.7MPa.
Nitrogen gas OUT side: Outer dia $\phi 8$ mm, Inner dia $\phi 5$ mm, Pressure resistance over 0.3MPa.
- ② Check that the tube is cut vertically, the cross section is circle and there is no damage.
- ③ Check that the tube plugs into depth surely and cannot be pulled out after mounting .
- ④ Connect Nitrogen gas (above 99.9% purity) to the N₂ IN side.
- ⑤ Tubing for N₂ OUT and BYPASS OUT shall be discharged to outdoor.
- ⑥ Adjust the pressure between 0.5–0.6Mpa with adjusting knob of the lower part of gauge by checking pressure gauge.
- ⑦ Turn the change-over handle to the MEAS side and adjust the flow rate between 1.9–2.1L/min with nitrogen gas flow adjusting knob by watching the flowmeter.
- ⑧ Turn this change-over handle to the PURGE side and adjust the flow rate between 4.9–5.1L/min with nitrogen gas flow adjusting knob by watching the flowmeter.



DANGER

It is very dangerous since this unit uses a N₂ gas in a high enclosed room.

Be sure to ventilate inside room. Also install oxygen detector. Nitrogen gas discharged from N₂ OUT shall be exhausted to the outdoor.

5. Operation method

5-1. Check items

- Wiring: Check that the main unit and personal computer etc are connected correctly.
- Tubing: Check that the given items(Tubing material or pressure etc) has no error or not.

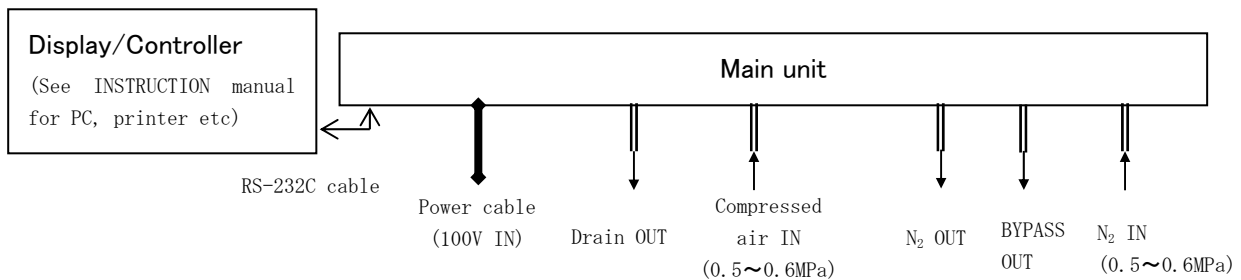

Wiring • Tubing diagram

5-2. Connection of power source

Before connecting the power source, check the followings.

- Check that breaker on the rear side panel is off.
- Check that the supply voltage is 100VAC, 50/60Hz.

The power cable of this unit and that of personal computer (including display, printer) are connected to the electric outlet with earth.



Earth (ground) terminal connection

- For safety, connect the power cable to electric outlet with earth (3P)
- When use the accessory transducer plug, ground to earth terminal.
- If not grounded, there is the possibility of electric shock.

5—3. Power ON

Make power on with the following procedure

- ① Turn power on for personal computer
- ② Check the Windows PC is set up.
- ③ Make ON the breaker on rear side of this unit.
- ④ Make “ON” (I side) in the front panel of this unit.



CAUTION

As this system may cause function error, do not make the following action absolutely.

- Make power on before Windows PC is set up.
- Start the AC-3 for Windows before error light flicker is put out.

5—4. Measurement

The measurement is carried out by use of AC-3 for Windows. For this detail, see AC-3 for Windows INSTRUCTION MANUAL 『How to measure the Work Function and Ionization Potential』.

Now, for correct measurement, the following attention shall be made.

- Avoid the sample contamination as possible as can be. For handling, use the tweezers. Take care not to give your breathing breath to the sample. (To avoid the adsorption by moisture in expiration)
- As the dust is much smaller than measuring scope area, this does not affect the measuring value in most cases. If you worry about it, remove it by tweezers or blow it out by air.
- Over 90% ultraviolet rays to be radiated is given to the spot of ultraviolet rays center of sample stage. Then, this is measuring scope. When over 2 kinds of materials co-existing on the surface of measuring scope, the photoelectron is discharged from them. Then, correct measurement can not be performed. Also, the photoelectron is discharged since the slight ultraviolet rays are radiated to the periphery of measuring scope.

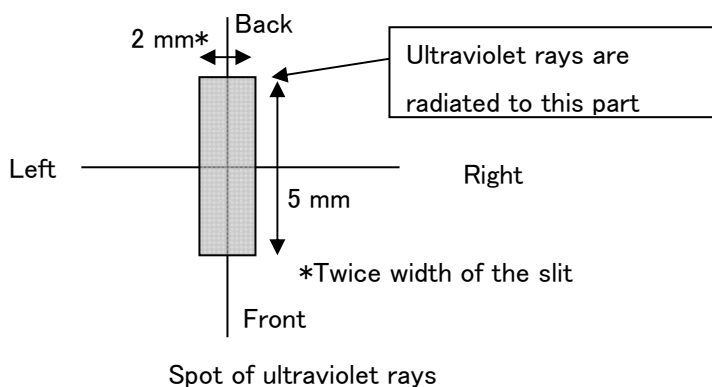

- Adjust the height of SAMPLE STAGE. (See “Measurement of Work Function and Ionization Potential” section in instruction manual of AC-3 for Windows.) It is possible to adjust at within $\pm 0.2\text{mm}$ by HEIGHT GAUGE. The radiation light beam comes in from optical fiber at angle of 30° . Then, if the height is deviated by 0.2mm , the deviation of the radiation position shall be 0.35mm .
- The configuration of sample is rectangle with thickness at 10mm , one stroke at $20\text{mm}\sim 30\text{mm}$ or powder material. (Use the optional sample tray for powder) For other material, it cannot be fixed at the sample stage and tends fall down from the sample stage during operation.
- When measure the same size sample or below as measuring scope, the attention is required. For example, when measure the photoemission property from ITO which was patterning to the same configuration with the spot of ultraviolet rays on aluminum plate with one stroke at 20mm , approx 10% ultraviolet rays shall be radiated onto aluminum though the position and height are adjusted precisely. As aluminum discharges over 50 times’ photoelectron of ITO, this result shows photoemission property from aluminum. In such case, it is recommended to measure by masking with tape which is difficult to discharge photoelectron. In this occasion, measure photoelectron emission behavior of the masking material and compare the data with them. Take note that abnormal measurement value will be taken on certain occasions if the masking material is electrified.
- The counting rate of photoelectron should be measured at the range of below 2000cps . From the relation of correction, the accuracy of counting rate at over 2000cps will be worse. The counting rate of photoelectron should be controlled by UV intensity.

5—5. Read out the width of slit

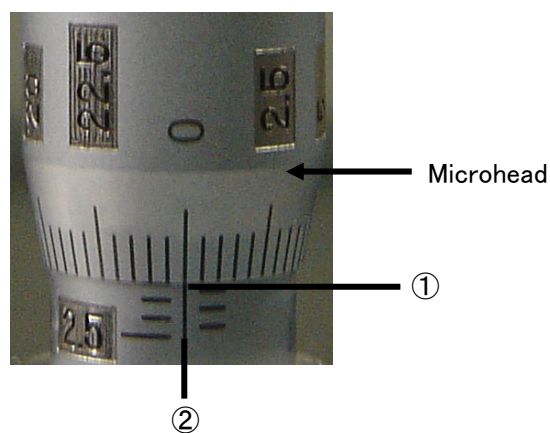

Read out the value of micro-head on an extension of ②line. In this occasion, current width of slit can be seen by checking the position of borderline①.

The photo shows that reading of micro-head scale is 0 and that of borderline is 1.0.

According to the above, the width of slit is 1.00mm. The width of slit changes 1.00mm by making micro-head 4 turns. When the borderline① is positioned at 2.5(the bottom of the scale from the left). The width of slit becomes 2.5mm.

5—6. Stopping the Operation

- ① When measurement form is opened in display/controller part(personal computer), chose it.
- ② After changing over the power switch on the surface panel of main unit from ON(| side) to OFF (○ side), make breaker OFF at the rear panel of main unit.
- ③ Turn off the compressed air at the main and stop the compressor.
- ④ When water is deposited in mist separator, turn the drain cock to the right and exhaust it. After exhausted out, be sure to close the drain cock.
- ⑤ Close the Windows and make off the power of personal computer, display, and printer.

* NOTE

Though the main unit remains OFF, the measurement can be edited by making start up the AC-3 for Windows.

6. MAINTENANCE CHECK

It is required to make the regular maintenance check to maintain the function and reliability of products.

6-1. Daily check

6-1-1. Checking indication lights

Check that POWER/STANDBY, TROUBLE and OPEN lights are turned on correctly.

•POWER/STANDBY light	:At measurement	Green light on
	During warming up.....	Green light flicker
•ERROR light	:At normal	Light off
	At trouble.....	Red light flicker
	At operation check.....	Red light flicker
	(Just after power on)	
•OPEN light	:When sample door is opened,.....	Orange light flickers.

6-1-2. Checking the inside of sample room

Before power one, open sample door and check that there is no dirt inside. If any dirt is found, remove it with the following method.

- ① Inhale the contamination by powders with the vacuum cleaner.
- ② Remove the dirt cohesive on the sample stage by use of waste etc soaked in the solvent.
- ③ When use the liquid such as solvent to remove contamination, open sample door and leave it for a few hours and use it after the volatile vapors go out from the sample room.



CAUTION

When measure with electrified powder or volatile solvent left in the sample room, it may give damage to the detector and shorten the life.

6-1-3. Checking the compressed air

Check that the supply pressure is between 0.5~0.7MPa and also, check pressure gauge, dew point checker and tubing.

- Pressure gauge for primary check :0.5~0.6MPa
- Pressure gauge for secondary check:At operation stop/within 15 min after power on ••0.0MPa
After 15 min from power on ••• 0.1~0.25MPa
- Dew point checker :To be green color

At trouble time, re-check supply pressure. If there is no trouble, see “AC-3 INSTRUCTION MANUAL” 『Consumable parts replacement method』 and check the air tubing system.

6-1-4. Checking the Nitrogen gas supply

Check that the supply pressure is between 0.5~0.6Mpa and also, check the pressure gauge and tubing.

- Pressure gauge: 0.05~0.1MPa
- Tubing for N₂ OUT shall not be choked and nitrogen gas shall be exhausted to outdoor.

6-1-5. Checking the reproducibility for the measurement of Work

Function

Measure the work function of test sample (metal plate) and check the reproducibility of work function.

- ① Measure the correction coefficient of light intensity (For measuring condition, see instruction manual for AC-3 for Windows “Measurement of Work Function and Ionization Potential.”)
- ② Measure the Work Function of the test sample. In this occasion, check that the Work Function is within a range of 4.6~.2eV and the slope is above 20Y/eV.
- ③ Measure test sample 10 times.
- ④ Check that the standard deviation of Work Function is below 0.02eV.

✕In case that the Work Function of test sample is varied due to environmental change, measurement value will be gradually changed. In this case, evaluate the data for 10 times measurement after measurement value is stabilized.

Example) Since that data from 1 to 3 times are fluctuated, use the data from 4 to 13 for calculation.

Times	1	2	3	4	5	6	7	8	9	10	11	12	13
Result	4.92	4.95	4.98	4.98	4.97	4.95	4.96	4.97	4.99	4.99	4.97	4.98	4.97

(Standard deviation=0.0119)

- ⑤ Check that the standard deviation of the slope is below 0.5 Y/eV.

6-2. Consumable parts

For replacement of consumable parts, see AC-3 instruction manual 『Consumable parts replacement method』.

6-2-1. Detector

If the anode of open counter for detector of AC-3 should get dirty, it becomes impossible to measure. When 「Troubled on detector」 was displayed (AC-3 for Windows) or the deterioration phenomenon of detector such as low detection efficiency, high noise and diversion of measurement value, replace it. The frequency of replacement is about 1 year.

The old sensors to be replaced can be reactivated by overhaul. The overhaul of this sensor should be contacted to Riken Keiki.

6-2-2. Ultraviolet rays (UV) lamp

This unit applies deuterium lamp to generate ultraviolet rays. Replace when the lamp blows or illumination gets unstable. The life of lamp is about 1500 hours.

6-2-3. Photomultiplier tube

The life of photomultiplier is about 5 years.

6-2-4. Maintenance of tubing system

It is hinted that replacement frequency of mist separator element and micro mist separator element are once in 2 years and that of membrane air dryer is once in 4 years. Then, the high pressure is given to the tubing system and checks the flaws, crack and other damages for deterioration could be checked, replace that parts swiftly.

7. Measures at abnormal case

7-1. Self-diagnosis at trouble

This is provided with self-diagnosis that each function check is made at power on and during operation. When the trouble is checked, it is impossible to make normal operation. Research the cause and take the appropriate measures.

Now, this shows the trouble at the following two methods.

(1) Function of AC-3 main unit:

At trouble, ERROR light (red) will flicker.

(2) Function of control PC:

At trouble time of software, it shows error message on the display.



When the control unit is scrambled at unexpected cause, there is the case that error message and flickering of ERROR light will not be displayed.

7-2. Responding to the trouble

Stop the operation and remove the trouble cause by seeing the next page. After removing the case, re-operate it and check whether trouble phenomenon will re-appear or not.

If trouble should re-appear with unknown cause of different trouble should appear continuously, note-down the trouble cause and inform it to Riken Keiki.

If there is the possibility that any harm could be given to human body by this trouble phenomenon, contact Riken Keiki without checking this re-appearance.

When the trouble data is measured, be sure to save this trouble data. In most cases, this will work for research of trouble cause.

7-3. Before it is thought to be a trouble

Symptom(S)	Probable causes	Recommend action
Cannot be power on	No plug into electric outlet of power cord	Make main switch off and plug right power cord in the electric outlet. Then, make power SW on.
	No power in the electric outlet.	
	Electric fuse is blown.	After checking why fuse blew out and found no problem, replace the fuse.
	The breaker on the rear side is broken down.	Make main SW off and after turning up breaker, make power SW on.
Can make power on but cannot operate	Sample door cover is open.	Close the cover and it automatically operates.
Communication fails though AC-3 for Windows is set up.	Connection of RS-232C cable fails	Re-connect RS-232C cable connection
	Communication trouble by momentary electromagnetic noise.	Re-start up the main unit and AC-3 for Windows.
Just power on, ERROR light A(red) will flicker.	Flicker showing function check.	No trouble when put out within a few minutes.
ERROR light B(red) will flicker.	The compressed air pressure is down.	Check the compressed air and re-start the main unit.
Trouble of detector is displayed.	Detector troubled	Replace detector
Setting trouble for light intensity is displayed.	Lamp is at trouble.	Replace lamp.

8. Definition of terms

Slope

This is the slope of graph between the energy of UV rays and photoelectron yield. It will be a hint of photoelectron emission.

Threshold energy

This is the threshold energy to start up photoelectron emission.

Work function

This is the required energy to take out 1pce electron.

Ionization potential

This is the lowest energy required for ionization of molecule and valence band maximum energy of semiconductor.

The energy of UV rays

Energy per one photon of radiation light beam. By wave length of radiation light, it can be calculated with following expression.

$$\text{Energy[eV]} = 1240 / \text{Wave length[nm]}$$

UV Intensity

Whole energy of radiation light per second. This can be calculated by output current of photo diode.

$$(\text{UV Intensity[nW]}) = (\text{The number of the photon of UV ray par 1 sec.}) \times (\text{energy[eV]}) \div 0.625$$

By photoelectron spectrum measurement, UV Intensity will be 5.90eV.

Light intensity correction

As there is the difference of every energy UV intensity, correct it. Suppose that the yield will be in direct proportional to UV Intensity. It shall be corrected by the following formula.

$$(\text{The counting rate after correction}) = (\text{The counting rate before correction}) \div (\text{The Number of photon}) \times (\text{The Number of photon of 5.90eV})$$

9. Measurement principle

9-1. Measurement principle of photoelectron

The AC-3 applies an open counter enable to count photoelectron in air. Fig 9-1-1 shows the principle diagram. The sample is placed just below the detector and is made grounding. The detector is composed of dual metal tube and metal wire being passed through the center of its tube. A part of this metal tube is composed of wire netting and called as suppressor grid and quenching grid respectively. At an initial stage, 80V and 100V each voltage is being supplied to them. The metal wire is called as an anode and approx 2900V is being supplied to it. An electron emitted from a sample surface by irradiation of ultraviolet rays is repeating collisions with oxygen molecule and moves toward the suppressor grid. After that, the electron attaches to an oxygen molecule, enters into detector and is carried toward the anode as a carrier. And it is accelerated by the intensified electric field around the anode and is separated from oxygen molecule. Accelerated electron by approaching closely to the anode ionizes and multiplies oxygen molecule by collision. This phenomenon is called as an electron slide. The electron multiplied by electron slide is collected to the anode and make generation of electric pulse at the external circuit. This pulse is captured by electric circuit and counts electron. Now electron slide generated by the electron emitting into the detector also generates a lot of positive ions. This positive ion moves toward the sample surface slowly than electron because of a large mass. However, if it lie, it makes a generation of electron slide unstable by the following electron or collides to the sample. Then, electric circuit captures and counts pulse signal, and at the same time changes voltage at quenching grid and suppressed grid to 400V and -30V respectively only for 3 msec. As a result, the potential difference between quenching grid and anode becomes small and stops a generation of electron slide. During this period a positive ion is neutralized by both grids and disappeared. The suppression grid prevents collision of positive iron to the sample, and also prevents the electron from entering into the detector during disappearance.

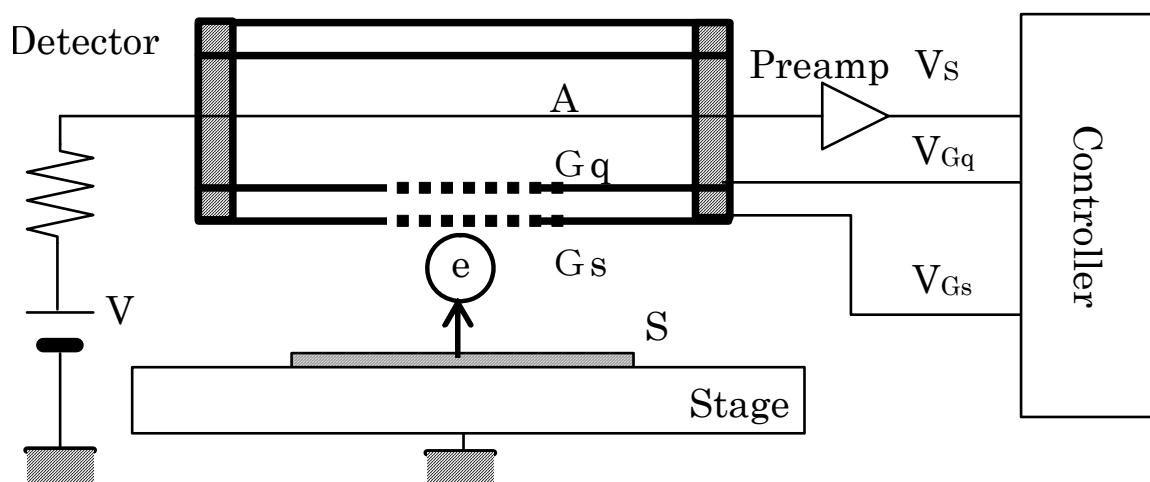

Fig 9-1-1 Open counter composition

Gs : Suppressor Grid Gq : Quenching Grid A : Anode

S : Sample  : Electron

9-2. Measurement of photoelectron work function

AC-3 consists of UV lamp, spectrometer, open counter, controller, X-Z stage and personal computer as shown in Fig 9-2-1.

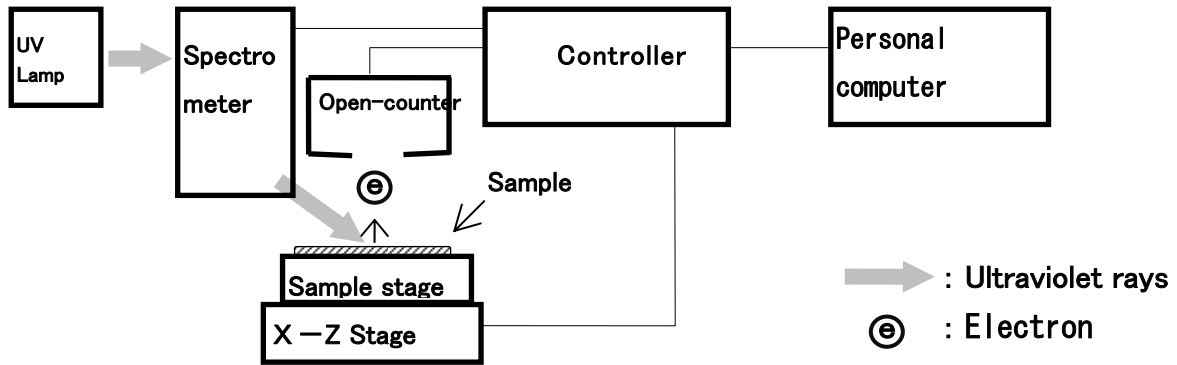

Fig. 9-2-1 AC-3 Composition

For the light source to emit ultraviolet rays, deuterium lamp is used. The light beam of wavelength 177.1~310nm emitted from the lamp is diverged into the arbitrary wavelength by spectrometer and radiated to the sample surface.

The energy E of this one photon is 7.0~4eV converting with $E=h \cdot c / \lambda$ (h : plank's constant, c : light velocity, λ : Wavelength). When shifting this irradiation light from low energy to high energy, photoelectrons start to emit at a certain energy level, due to photoelectron effect. This energy level is called the "Photoelectron Work Function."

The photoelectron work function is dealt with "Work Function" for the metal sample and "Ionization Potential" for the semiconductor sample respectively.

If the test sample is a metal, the relationship between the photon energy(UV energy, X axis) and the square root of yield ratio (Y axis) is a linear line. And the photoelectron work function is obtained by the crossing point of the back

ground and the yield obtained from the mini square root as shown in Fig 9-2-2.

Also the slope of yield line becomes a index of the surface contamination, oxidized film thickness and so on.

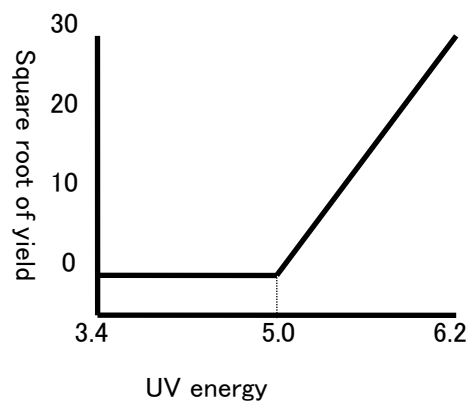

Fig 9-2-2 Relation between UV energy and electron

10. List of product specifications

10-1. Product specifications

10-1-1. Main unit

Model	AC-3
Measurement method	Low energy electron counter method
Energy scanning range for photoelectron measurement	4.0~7.0eV(310~177.1nm)
Energy scanning range for UV intensity measurement	4.0~7.0eV(310~177.1nm)
Repeatability precision (Standard deviation)	Work function 0.02eV
Measurement time	Standard time required for work function measurement : Approx 5min (Energy scanning range : 5.0~7.0eV, Step: 0.1eV, Counting time: 10 sec / 1 energy)
Ultraviolet rays lamp	Deuterium lamp with lamp house
Ultraviolet rays spot size	2.5 × 5mm (at 1.00mm slit)
Spectrometer	Nitrogen substitution type grating monochromator
Sample	30mm × 30mm Max, Thickness 10mm Max 1 pt measure at the center of sample stage
Stage	Z axis (Manual) : 10mm
Operating temp/humidity	15~35°C、Below 60%RH
Power requirement	100VAC, 50/60Hz 5A(MAX)
Compressed air	Pressure: 0.5~0.7MPa, Flow rate: 5.5NL/min and above Tubing : 6mm O.D., SUS or PTFE tubing
Compressed nitrogen	Purity: Above 99.9%, Pressure: 0.5~0.6MPa, Flow rate: 2NL/min at measurement, 5NL/min at purging Tubing : Intake 6mm O.D., Outlet 8mm O.D., SUS or PTFE tubing
Dimension	Approx 740(W) × 680(D) × 985(H) without caster
Weight	Approx 120kg

10-1-2. Display unit (Personal computer)

Display	Resolution : Over 1024 × 768 pixel
Personal computer	Desk top Processor: Celeron 600MHz or over Memory: Above 512MB Hard disk : Space over 40GB RS-232C port (D-SUB 9 pins) CD-ROM drive Mouse
Printer	Color,
OS	Windows 7

※The above specifications are the minimum recommendation to operate AC-3 for Windows. For details, refer to instruction manual or specification sheets for display unit which will be attached separately.

10-1-3. Software function (AC-3 for Windows)

Function	Description
Work function measurement	By measuring photoelectron spectrum, the work function or ionization potential can be determined.
Automatic light intensity adjustment	If load in the target UV intensity, UV intensity is adjusted automatically.
Automatic system start up function	Initial of the system and anode voltage of detector is automatically set up.
Cut and paste function	The measurement data is made use of by other application software through cut and paste. (Japanese edition: Function check finished only for Word 2000, Excel 2000)
Energy scanning function	Photoelectron can be counted by scanning the UV energy in the range of 4.00~7.00eV.
Light intensity correcting function	Light intensity can be counted by scanning the UV energy in the range of 4.00 ~ 7.00eV. Reliance to the UV intensity of photoemission quantity can be corrected with this measurement valve.
Photoelectron spectrum display function	Scales of horizontal axis and vertical axis for photoelectron spectrum can be changed.
Power number calculation function	Calculates the power number on vertical axis of photoelectron spectrum graph and make decision of work function or ionization potential easily.
Light intensity spectrum display function	Displays the light intensity spectrum for light intensity correction.
Graph comparison function	Displays graphs simultaneously and they are comparable (Max 5 graphs)
Multiple display function	Plural form can be opened simultaneously (Max 5 forms)
Data explorer function	Easy to deal the data with data display function by explorer form.

10-2. Composition list

- Photoelectron Spectrometer in Air(AC-3) 1set
- Standard accessories 1set

10-2-1. Standard accessories

- Display/controller (with instruction manual and warranty sheet) 1set
- Power cable 1pce.
- Conversion plug 1pce.
- UV lamps with holder 1pce.
- Standard sample holder and cover 1pce.
- Tweezers 1pce.
- Spanner 1pce.
- AC-3 instruction manual 1vol.
- Detector (LE-6110) 1 pce.
- Standard sample 1 pce
- Communication cable (RS-232C) 1 pce.
- Ball-point driver 1pce.
- System software (CD-ROM) 1pce.
- Warranty sheet 1sheet

10-2-2. Optional accessories

- Powder sample tray 20pcs/set
- Compressor (C3-AIR)※
- Fermi level measuring instrument (FAC-2)

※The supply condition of compressed air is pressure at 0.5~0.6MPa and flow rate at over 5.5NL/min.
The tubing should be nylon tube with over $\phi 6$ mm (outer dia), $\phi 4$ mm(inner dia) and over 0.6MPa (Pressure resistance).

10-2-3. Maintenance parts

- Detector (LE-6110)
- Element for micro mist separator
- Membrane module
- Element for mist separator
- Ultraviolet rays lamp for AC-3

—How to measure the Work Function and
the Ionization Potential—

Contents

1.	Outline	1
2.	Caution	1
3.	How to use this manual	1
4.	Flow of measurement	2
5.	Preparation of equipment	3
6.	Preparation of system	4
7.	Measurement of photoelectron spectrum	5
8.	Measurement of light intensity correction coefficient	14
9.	Determination of work function and ionization potential	17
10.	Comparison of graph	21
11.	Display of light intensity correction coefficient	23
12.	Print-out	24
13.	How to finish windows	25
14.	Other function	26

1 . Outline

This manual describes how to seek for work function and ionization potential by measuring the photoemission threshold energy of the test sample with AC-3.

2 . Caution

This manual is described in the premise of following.

- ① AC-3 and personal computer are set up correctly.
- ② AC-3 for Windows is correctly installed.
- ③ Operator knows Operation of Windows.
- ④ Operator knows the meaning of work function, ionization potential and relation with photoelectron emission.

* Prior to this manual, read INSTRUCTION MANUAL for PHOTOELECTRON SEPCTROMETER AC-3 and Windows INSTRUCTION MANUAL.

3 . How to use this manual

For users who use AC-3 first, prepare the standard sample and tweezers, and start to measure according to this manual. The set condition required at that time, see the example. The experienced users, see * Note and start to measure.

Read this manual well and arrange to measure correctly.

4. Flow of the measurement

Below is the measurement flow. The number corresponds to chapter.

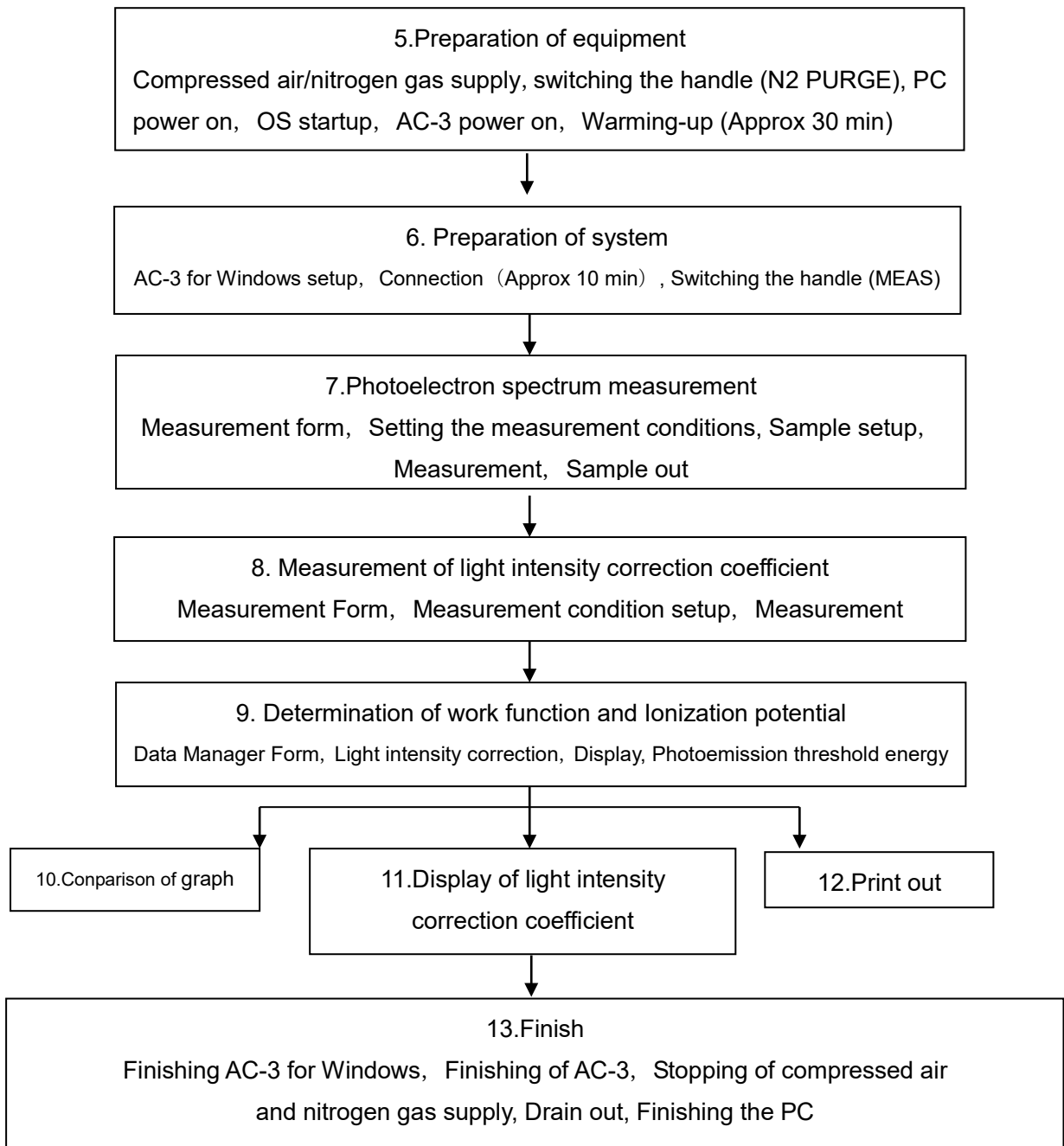

5 . Preparation of equipment

It is prepared to measure by AC-3.

- ①Supply the compressed air (0.5–0.7Mpa) .When supply it by pump, make this power on. When supply from factory piping, open the original supply valve.
- ②Place the nitrogen flow change-over handle to PURGE side and supply the compressed nitrogen (Purity: Above 99.9%, Pressure: 0.5~0.6MPa).



Verify that the nitrogen gas is exhausted to outdoor. It is dangerous if nitrogen gas would be pervaded in a closed indoor. Recommend to install our oxygen deficiency alarm.

- ③Make POWER SW of personal computer ON and start up Windows.
- ④Check that Windows is started up.
- ⑤Make on the breaker power at the real panel of main unit (LC1).
- ⑥Make on (| side) the POWER SW on the surface panel LC1.
- ⑦Warming up starts with power ON. After completion of warming up (After about 30min) POWER/STANDBY light will turn green lighting.

* NOTE

For checking the past measurement data, you may proceed to “6. Preparation of system” just after ④. (After warming up and connection, start to measure.)

6 . Preparation of system

Prepare the personal computer and AC-3 for Windows.

6-1.Preparing the system

- ①Start up AC-3 for Windows. Example) start up program of like 『start』 → 『Program』 → 『AC-3 for Windows』 .
- ②Open Main Form and Data Manager Form.

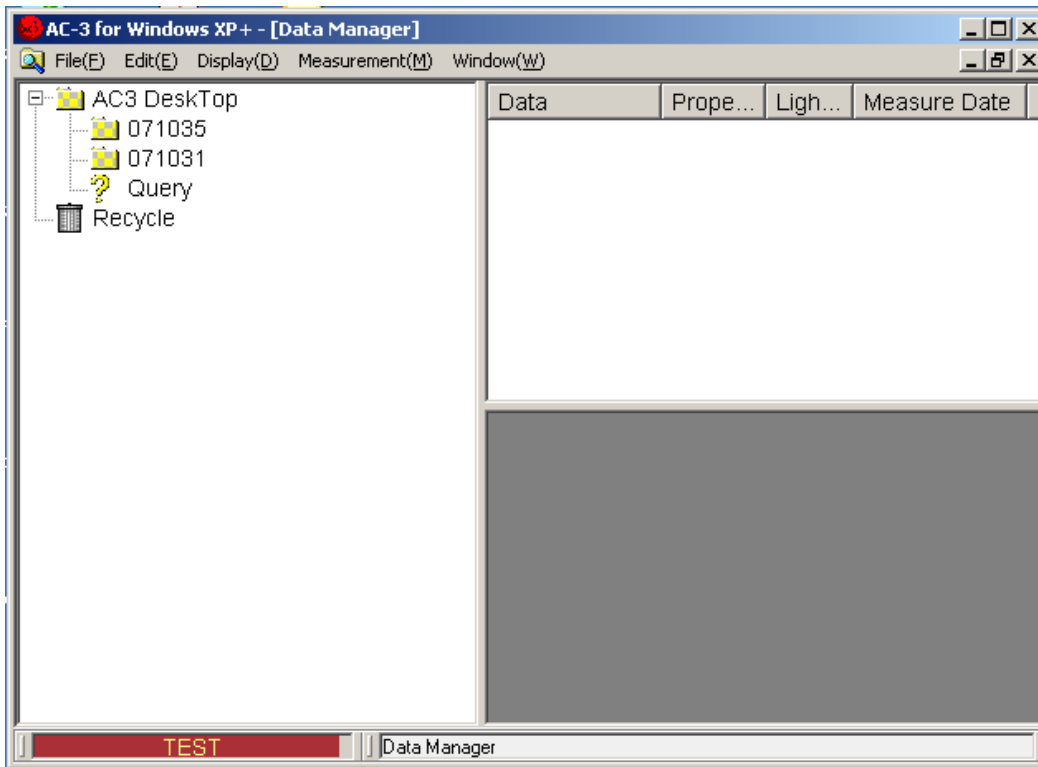

6-2.Connection

- ①Enter the **Measurement(M)–Connection(N)**.
- ②Prepare Connection. Connection means the establishment of communication with main unit, **Initialize Light Intensity Adjuster** and **Setting Anode Volts**. The existing status is displayed on **Status Window**.
- ③After about 10minutes, Connection is finished. Anode Voltage and ready condition of AC-3 are displayed. Click **OK** on message box.

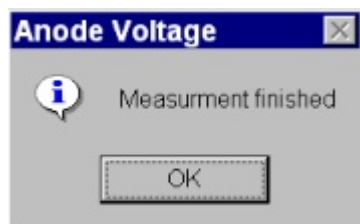

CAUTION

When make other application software treatment or that of AC-3 for Windows during connection or measurement through OS spec, there is the case of inability for communication. During communication treatment with main unit for connection and measurement, do not let personal computer make other treatment.

After completion of connection, place the nitrogen flow change-over handle to MEAS side and verify that flow rate of compressed nitrogen is 2L/min.

7 . Measurement of photoelectron spectrum

7-1.Make up folder and starting the Work Function Form

- ①Click the icon of AC-3 Desk Top and make it active.
- ②Enter **File(F)–Create Folder(W)**.
- ③Enter **Folder name**. Example) test
- ④Check that the prepared **Folder** is active.
- ⑤When select **Measurement(M)–Work Function**, the work Function Form is opened.

* NOTE

When the another form is active, Measurement Form cannot be started.
When Measurement Form is started up, close beforehand and open Work Function Form.

7-2.Explanation of Work Function Form

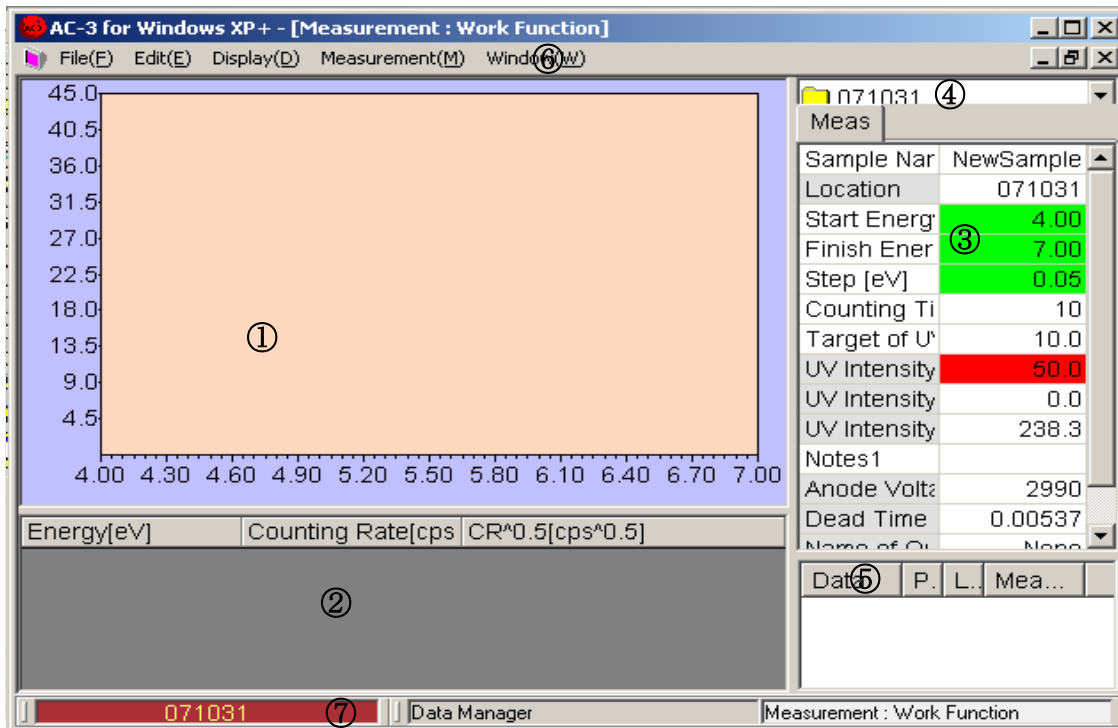

① Graph

The measurement data is depicted on the Graph.

② Data Table

The measurement data is listed.

③ Control List

The required condition for measurement can be entered. After clicking the right side box for each items of words and number, enter from key board. For selection, when click the right side box, ▼ button is displayed. When click it, the selection menu is displayed. Select it from this.

④ Location window

This shows the Folder filing the measurement data.

⑤ Light intensity correction coefficient Window

This displays **Light intensity correction coefficient number** used for light intensity correction.

⑥ Menu Bar

This changes over measurement and form.

⑦ Task Bar

This shows the existing condition and changes over form.

* NOTE

The default of Control List is in the same condition as last measured data.

7-3.Measurement condition setup

Enter measurement condition from **Control List**.

- ①Enter the sample name. The name entered here will be the name of Work Function Data File displayed in the Data Manager Form. Click the right side box of **Sample Name**. Operate key and press Enter. When re-write the sample name entered already, press space key after having clicked.
Example) TEST
- ②When click **Location Window**, it shows folder. Select the folder to file measuring data from now on. Example) test
- ③Enter **Start Energy**. Example) Open List Box of **Start Energy** and select 4.20eV.
- ④Enter **Finish Energy**. Example) Open List Box of **Finish Energy** and select 6.20eV.
- ⑤Enter **Step**. Example) Open List Box of **Step** and select 0.10eV.

* NOTE

When make preliminary measurement, it shall finish sooner by spreading Step.

- ⑥ Set up **Counting Time**. Example) 10
- ⑦Set up UV Intensity. Firstly enter **Target of UV Intensity Adjustment**. Target of UV Intensity Adjustment should be set up between UV Intensity(Max) and UV Intensity(Min). Example) 10
- ⑧Select **Measurement(M)-UV Intensity Adjustment(L)** of Menu Bar. As message box of UV Intensity Adjustment is displayed, click **YES(Y)** and start up automatic control of UV Intensity. When finish controlling, UV Intensity will be the same as Target value. When finish UV Intensity Adjustment, the message box which finishes set-up will open and click OK. Now, the black color of Control List will be green at $\pm 5\%$ of target, yellow at $\pm 5\sim 20\%$ of target, and red at over $\pm 20\%$ of target.

* NOTE

- Appropriate UV Intensity differs by sample. make preliminary measurement of photoelectron spectrum and arrange so that an appropriate slope can be obtained.
- When Target of UV Intensity Adjustment is near from the Minimum or maximum of UV Intensity, there is the case that it can not be set at within $\pm 5\%$ of set value. In this case, message box for UV intensity measurement failure is displayed.



When open the cover of SAMPLE DOOR during measurement of UV Intensity, the sample stage may move suddenly and give inquiry by it. Or there is the case that UV Intensity gets troubled.

- ⑨ Input **Power Number**. Power Number is that of vertical line for data to be displayed on Graph. Input the decimal number below 1. Example) 0.5
- ⑩ Input information of measuring sample, material etc in **Notes 1**.
- ⑪ Select **Light intensity correction coefficient**. Select light intensity correction coefficient file to be used in the light intensity correction window and double click it. When make light intensity correction later, right click the name of light intensity correction coefficient on control list to delete it. Example) **Adjustment Data Delete**

7-4. Sample mounting

- ① Enter **Measurement(M)-Sample(S)** on Menu Bar.
- ② As message box of sample stage confirming the movement is displayed, click **YES(Y)**.
- ③ Check that the roaring sound of sample stage could not be heard and open the door.

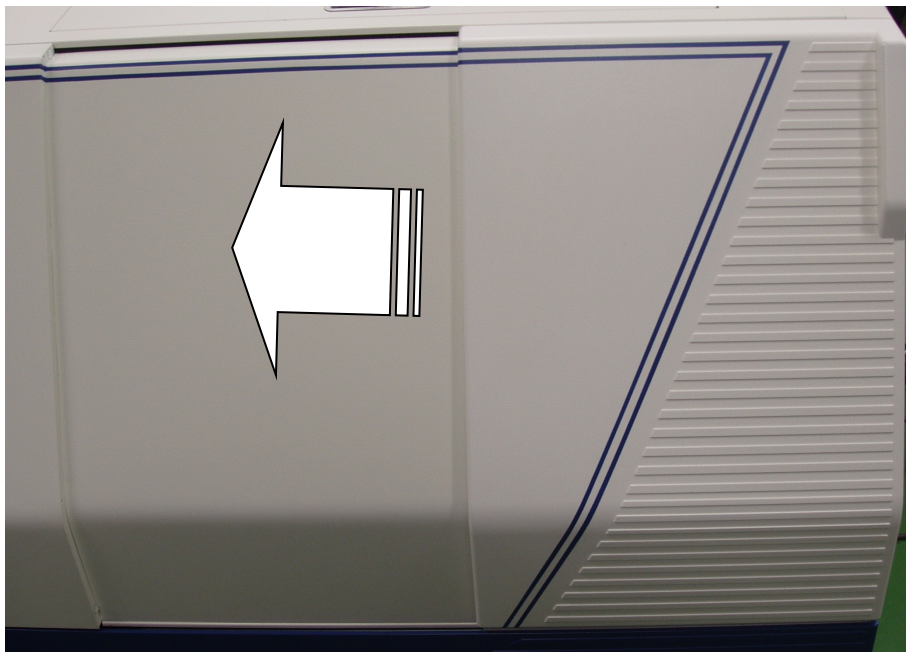

- ④ Push the cover of SAMPLE DOOR on the part marked “Push” and when tick sound could be heard, release your hand.



- ⑤ SAMPLE DOOR cover is open. Check that OPEN light will flicker in red.

WARNING

When OPEN light cannot flicker in red, there is the interlock trouble. In this case, even if SAMPLE DOOR cover is open, there is the possibility that sample stage will move.

- ⑥ Put SAMPLE to the left side of you on SAMPLE STAGE.

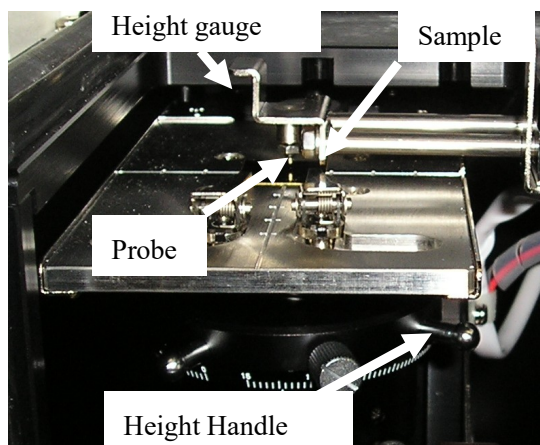

- ⑦ Control the sample stage height level. Put SAMPLE on left side of SAMPLE STAGE. Next, draw HEIGHT GAUGE and sandwich the SAMPLE between SAMPLE STAGE. Then, Rotate Height Handle of sample stage so that the top end will correspond to the height of measuring unit.

⚠ WARNING

When put a part of sample in higher position than HEIGHT GAUGE probe, there will be possibility that the main unit or sample may be damaged by the crush of detectors. Then be sure to control the height.

- ⑧ Fasten Sample by sample clip in the center of sample stage.

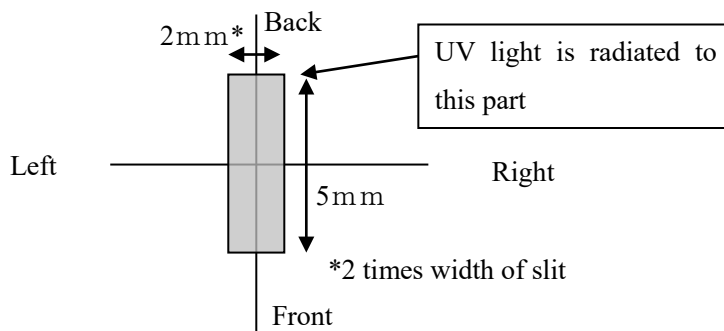
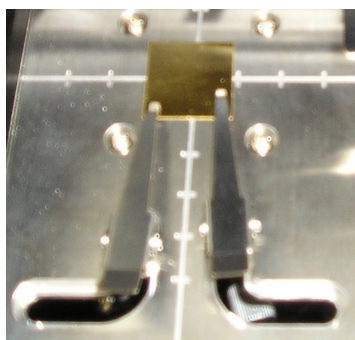
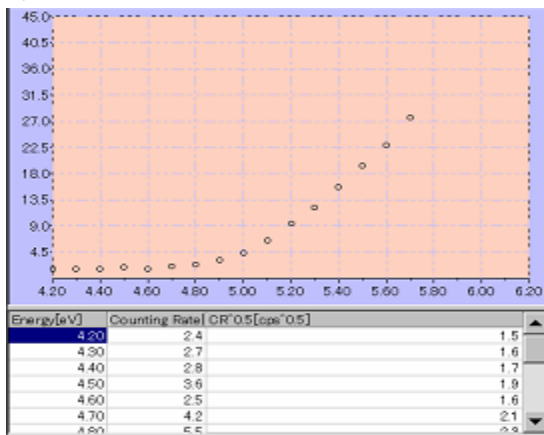

Figure for UV light spot

- ⑨ Close the SAMPLE DOOR and push in the vicinity marked "Push". Release hand until it sounds ticking.
- ⑩ Check that SAMPLE DOOR is closed and click OK on screen.

7-5.Measurement

- ① When select **Measurement(M)-Measurement(G)** of Menu bar, the photoelectron spectrum measurement will start.
- ② When measurement starts, Graph and data shall be displayed and the counting rate of each energy is plotted. The horizontal line of Graph is the energy of UV rays and the unit is eV. The vertical line is the power number of the counting rate and the unit is [cpsⁿ]. This “n” is the power number. The upper limit of vertical line will automatically be about 2000ⁿ.
- ③ After measurement of background, quantity of photoelectron is measured every energy of UV rays in turn.



While in measurement

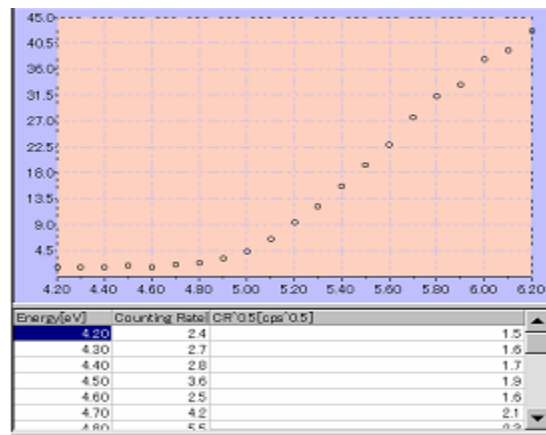

Measurement finished

- ④ When the measurement is finished, the message box showing finish will open and click **OK**.

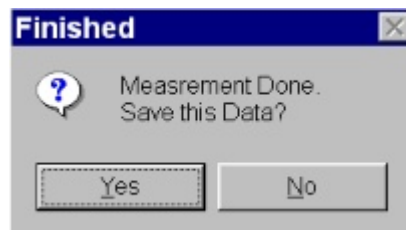
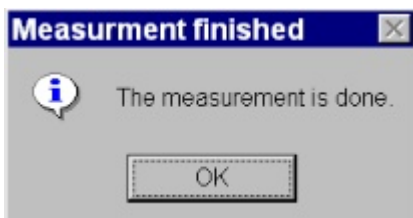

CAUTION

From OS spec, when make treatment of AC-3 for Windows and other application soft during connection and measurement, there will be possibility of no communication with main unit. While communicating with main unit such as connect, measurement, do not let the computer do other treatment.

*NOTE

Measurement is interrupted by **Measurement(M)-Measurement Cancel(G)**.

⑤ When UV Intensity is small or the range of measuring energy is not appropriate, control them and start re-measurement.

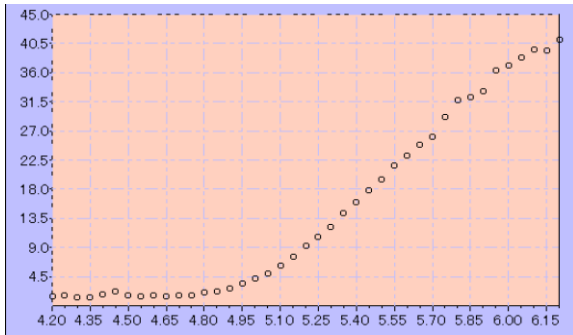

Step 0.05eV

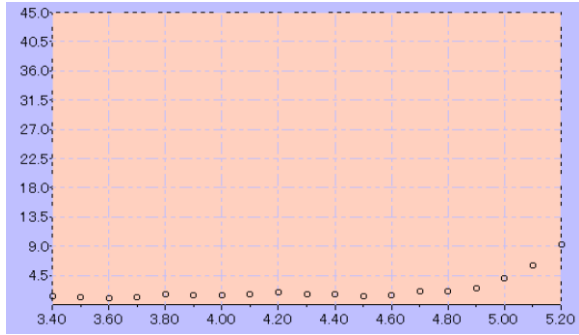

Defect in energy range

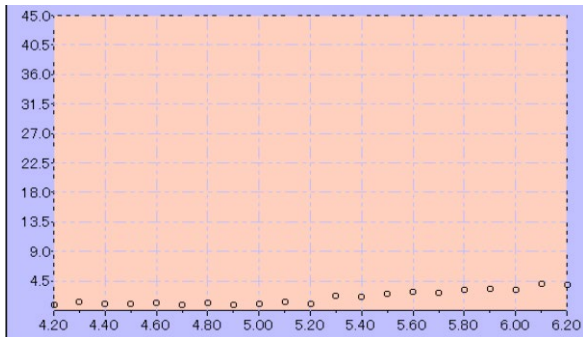

Low UV Intensity

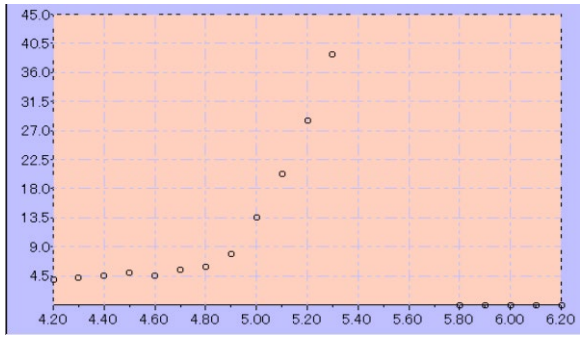

High UV Intensity

7-6.Sampling

- ① Select the **Measurement(M)-Sample(S)** of Menu Bar.
- ② Check that the message box is displayed and active sound of sample stage becomes off.
- ③ By pushing SAMPLE DOOR on the part of Push marking, release hand after tick sound could be heard.
- ④ SAMPLE DOOR gets open.
- ⑤ Take out sample.
- ⑥ Close by pushing SAMPLE DOOR on the part of Push marking and release hand after tick sound could be heard.
- ⑦ Check that SAMPLE DOOR is closed and click **OK** on the screen.

7-7.Setting Anode Voltage, Initializing Light Intensity Adjuster

After connection, when continue to measure for a long hour of over 24 hours or temperature and atmospheric pressure varies, re-set Anode Voltage and initialize Light Intensity Adjuster.

1) Resetting anode voltage

The re-set of Anode Voltage shall automatically be carried out by operating **Measurement(M)—Anode Voltage(V)**. It finishes after about 5 minutes and as the message box is open, click **OK**.

2) Initializing light intensity adjuster

Initialization of Light Intensity Adjuster shall automatically be carried out by operating **Measurement(M)-Initialization by Light Intensity Adjuster (I)**. It finishes after about 5 minutes and as the message box is open, click **OK**.

7-8.How to finish Measurement Form

Under active condition of Measurement Form, finish Measurement Form by **File(F)—Close(X)**.

8. Measurement of light intensity correction coefficient

8-1. Start-up of light intensity correction coefficient form

- ① By Data Manager, click the folder and make it active.
- ② When select **Measurement(M)–light intensity correction coefficient(L), Work Function Form** shall open.



For other measurement form, close it in advance and then open light intensity correction coefficient Form.

8-2. Explanation of Light Spectrum Form

Energy[eV]	UV Intensity[nW]	Photon Number[cps]
4.00	2.3	3.62E+9
4.10	2.5	3.84E+9
4.20	2.9	4.26E+9
4.30	3.1	4.45E+9
4.40	3.1	4.36E+9
4.50	3.0	4.24E+9
4.60	3.0	4.11E+9
4.70	3.1	4.09E+9
4.80	3.2	4.20E+9
4.90	3.5	4.44E+9
5.00	3.9	4.92E+9
5.10	4.6	5.67E+9
5.20	5.5	6.62E+9
5.30	6.5	7.67E+9
5.40	7.5	8.69E+9
5.50	8.4	9.50E+9
5.60	9.1	1.01E+10
5.70	9.5	1.04E+10
5.80	9.8	1.06E+10

Sample Name	071031-10nW
Location	071031
Start Energy	4.00
Finish Energy	7.00
Step [eV]	0.10
Target of U	10.0
UV Intensity	10.0
UV Intensity	0.0
UV Intensity	238.3
Notes1	

① Data Table

Make list of the measurement data.(Space before measurement starts)

② Control List

Enter the required conditions for measurement(How to enter is the same as Work Function Form.)

③ Location Window

This indicates the folder filing the measurement data.

④ Menu Bar

This makes measurement and change-over of form.

⑤ Task Bar

This indicates the current condition and changes over the form.

8-3.Measurement condition setup

Input measurement condition from control list.

- ① Input the **Sample Name**. The name inputted herewith will be the **name of Light Spectrum Data File** shown on **Data Manager Form**. Click the right side box of sample name and input the word with keyboard. Then, press Enter. When try to re-write the Sample Name, input by pressing space key after click. Example) test
- ② When click **Location Window**, it shows folder. Select the folder filing Light Spectrum Data to be measured from now on.
- ③ Input **Start Energy**. Example) Open the List Box of **Start Energy**. Select 4.20eV.
- ④ Input **Finish Energy**. Example) Open List Box of **Finish Energy**. Select 6.20eV.
- ⑤ Input **Step**. Example) Open List Box of **Step**. Select 0.10eV.

* NOTE

When make preliminary measurement, this finishes earlier by widening **Step**.

- ⑥ UV Intensity shall be set up. When measure at the same value with the current UV Intensity (Measured **UV Intensity**) ,input the value of $\pm 5\%$ of UV Intensity to Target of UV Intensity Adjustment. Example) 10
- ⑦ When set UV Intensity newly, input **Target of UV Intensity Adjustment** and select **Measurement(M)-UV Intensity Adjustment(L)** of Menu Bar.
- ⑧ Input the information such as measurement condition at **Notes 1** .

8-4.Measurement

- ① By selecting **Measurement(M)-Measurement(G) of Menu Bar**, start measurement.
- ② When start measurement, light intensity correction coefficient of the each energy is shown on data table.
- ③ When finish measurement, the message box is opened and click **OK**.
- ④ As the message box is opened, click **YES(Y)** button and save it.

CAUTION

From OS spec, when make treatment of AC-3 for Windows and other application soft during connection and measurement, there will be possibility of no communication with main unit. While communicating with main unit such as connect, measurement, do not let the computer do other treatment.

8-5.How to finish Measurement Form

Under active condition of **Measurement Form**, close the form from **File(F)-Close(X)**.

9 . Determination of the work function and the ionization potential

Click **Data Manager** button of Task Bar and make Data Manager Form displayed.

9-1.Explanation of Data Manager Form

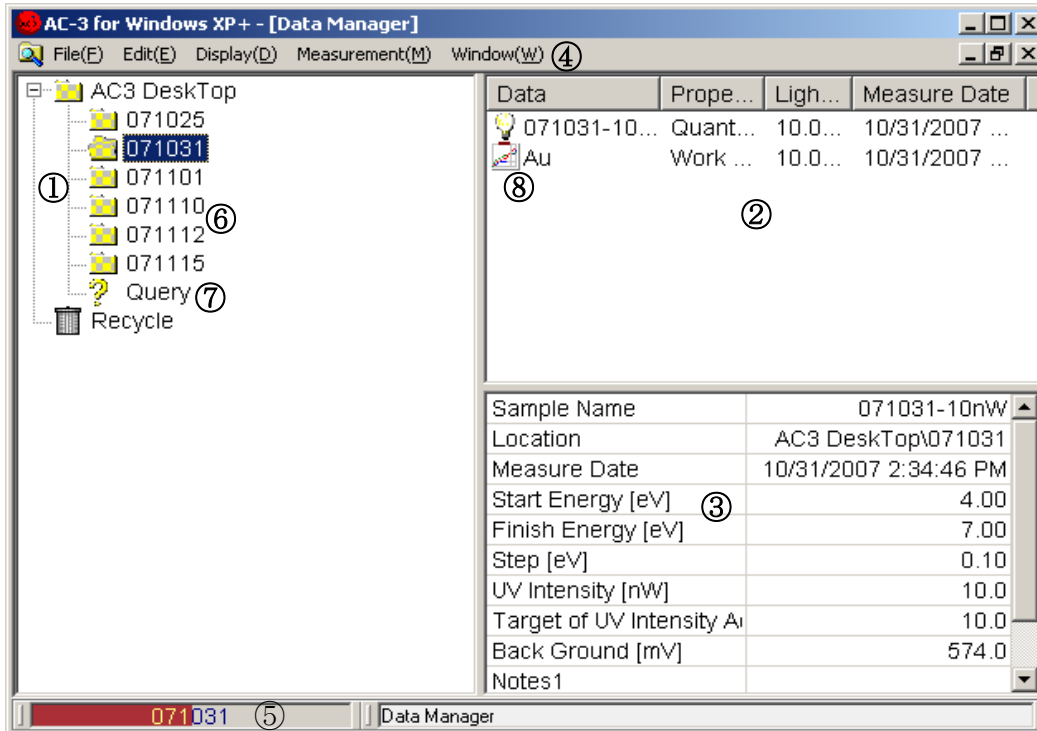





- ① **Tree**
Displays folder into tree form.
- ② **Data Manager**
Displays data or folder.
- ③ **List Table**
Displays data outline.
- ④ **Menu Bar**
Makes Print, Delete, Create Folder, Move, and Rename of data
- ⑤ **Task Bar**
Indicates the name of data or folder selecting now and changes over form.
- ⑥ **Folder**
The measurement data is stored.
- ⑦ **Query Folder**
Searched result.
- ⑧ **Data**
- ⑨ **Measurement data**

9-2. Light intensity correction

- ① Firstly, Open the folder. [Example) User Name] where the photoelectron spectrum data to be corrected is filed.

* NOTE

The folder with  in left is provided with much lower layers. When click , the lower folder can be displayed. At this time,  becomes . When click , lower folder can be non-displayed.

- ② Click and select **Light Spectrum Data File** [Example) TEST] to use for correction, operate the copy(C) of **pop up menu** by right click.
- ③ Select **Work Function Data File** [Example] TEST] and operate the Paste (P) of **pop up menu**. When correction is made, **name of light intensity correction coefficient** on list table displays the name of light intensity correction data [Example) TEST] used for correction. .

* NOTE

When ceases light correction, right click the **Name of light intensity correction coefficient** and operate light correction data exception.

CAUTION

When delete **Light Spectrum Data File** related with Work Function Data File, database may cause trouble. In this case, there is the case to replace with back up of database.

9-3. Display of Graph

Select **Work Function Data File** [Example] TEST] desired to analyze and making active **File(F)** —**Open(O)**, open **Single Graph Form**.

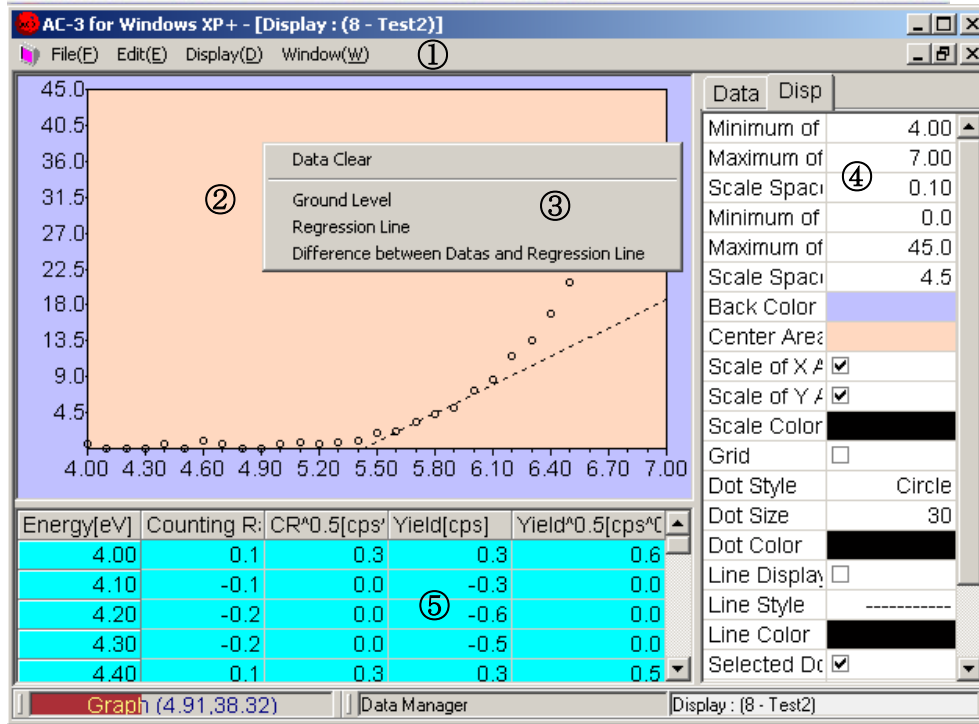

① Menu Bar

This makes data copying.

② Graph Box

Display the measurement data as Graph.

③ Pop up menu

To seek for the threshold of graph, this is used when draw Ground Level and Regression Line.

When there is the mouse pointer located in the Graph Box, it is displayed by right click.

④ Control List

This can input the depicted condition of Graph.

⑤ Data Table

Display the measurement data as table.

⑥ Task Bar

Indicate the coordinates of mouse pointer on **Graph Box** or change over the form.

9-4. Determination of Photoemission threshold energy

This determines the photoemission threshold energy of measured spectrum. This value is interpreted as work function and ionization potential.

- ① Click Data tab of Control List and by making **Power Number** at 0.5, make Y axis for a square root of yield.

* NOTE

Appropriate power number shall be different from material each. Check it with thesis etc. Generally speaking, it is said that the power 0.5 is for the metal sample, the power 0.3(1/3) is for semiconductor and the power 0.5 is mostly for organic material.

- ② Click **Disp tab** of Control List. Control the display condition of Graph suitably.
For numbers etc, input it from keyboard after click the box.
When check for check box, it becomes on and when make it off, it will be off.
For example) Minimum of X Axis [eV] : 4.20, Maximum of X Axis [eV] : 6.20, Scale Space of X Axis [eV] : 0.10, Minimum of Y Axis [CPS^{0.5}] : 0.0, Maximum of Y Axis [CPS^{0.5}] : 45.0, Scale Space of Y Axis [CPS^{0.5}] : 4.5, Back Color : default, Center Area Color : default, Scale of X Axis : On, Scale of Y Axis : On, Scale Color : default, Grid : Off, Dot Style : default, Dot Size : 30, Dot Color : default, Line Display : Off, Line Style : default, Line Color : default, Selected Dot : On, Selected Dot Style : default, Selected Dot Size : 35, Selected Dot Color : default.
- ③ By guessing the plain part of Graph, select the range by click and drag. After selection by right side, display the pop up menu. Then, click the Ground level.
- ④ By guessing **the range of Regression Line**, select by click and drag. After selection by right side click, display the pop up menu and click Regression Line.
- ⑤ On the **Data tab** of Control List, **Work Function**, **Gradient of Regression Line** (slope) are displayed.
- ⑥ By **Edit(E)-Copy(C)**, graph and data can be copied on the clipboard and it can be used in other application of Windows. After click on the display desired to copy in advance, start up **Edit(E)-Copy(C)**.
- ⑦ When close the form, start up **File(F) — Close(X)**. Now, when the form is closed, this shall be updated.

* NOTE

Single and Multiple Graph Form cannot be displayed over 5 copies.

1 0 . Comparison of Graph

By displaying upto 5 copies graphs on Multiple Graph Form concurrently, the comparison can be made. The graph for this comparison shall be required in the same folder.

10-1. How to open Multiple Graph Form

- ① Open the form provided with Graph on the **tree** (①) of Data Manager Form, and let the desired data displayed on Multiple Graph Form of Data Manager (②) .

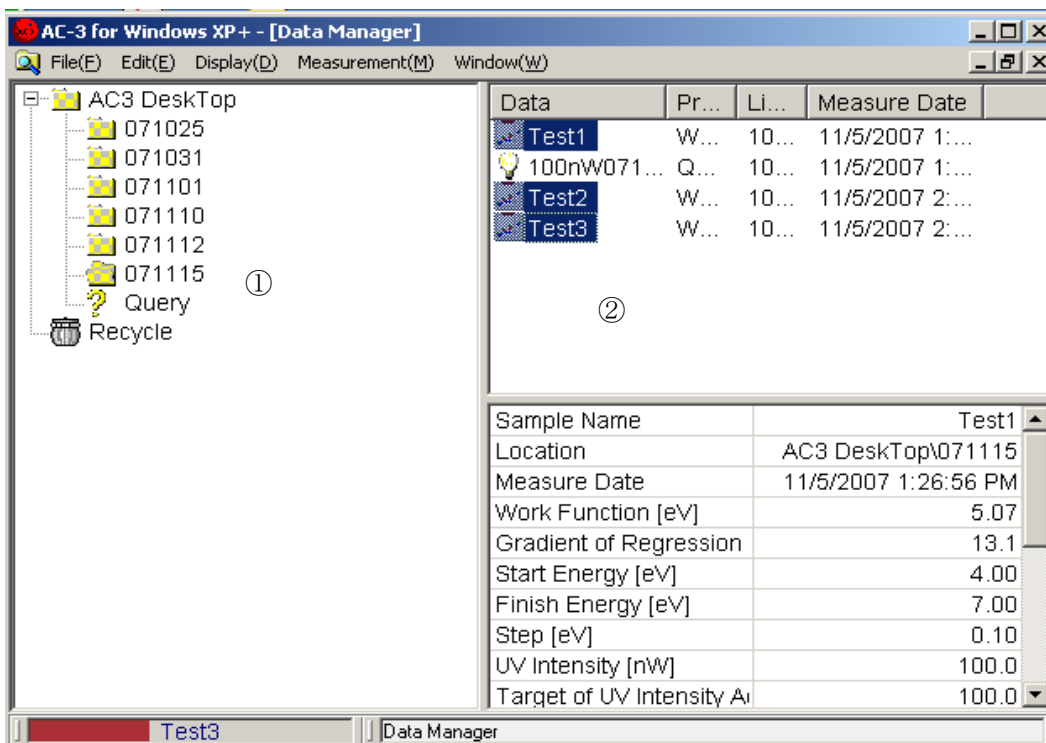

- ② Click the icon of Work Function Data File desired to depict as Graph by holding on pressing Ctrl key, all the those file can be selected simultaneously.
- ③ Open the pop up menu by right click and click [Open].
- ④ **Multiple Graph Form** shall be open.
- ⑤ When close form, start up **File(F)–Close(X)**.

10-2.Explanation of Multiple Graph Form

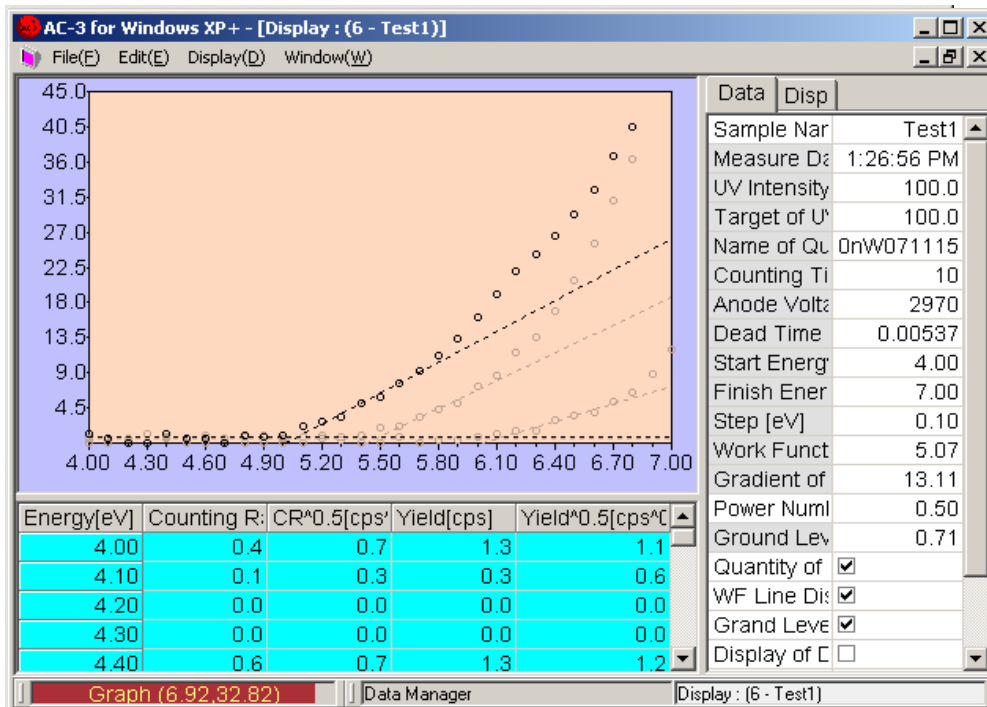

- ① Except the Graph of data selected on **Sample Name**, it is depicted with the same ratio specified in “Non-selected transmission factor” of the Disp tab.
- ② The selected data at **Sample Name** is displayed on **Data Table**.
- ③ When select a different data, click Sample Name. Then, as the button is displayed and click it to select the data name of others to be displayed.

1 1 . Display of light intensity correction coefficient

- ①After selecting **Light Spectrum Data File** [Example] TEST] desired to display, start up **File(F)** – **Open(O)** and open Display Form.
- ②By **Edit(E)-Copy(C)**, paste the data on clipboard and can use the Windows through from other applications.
- ③When close the form, start up **File(F)** – **Close(X)**.

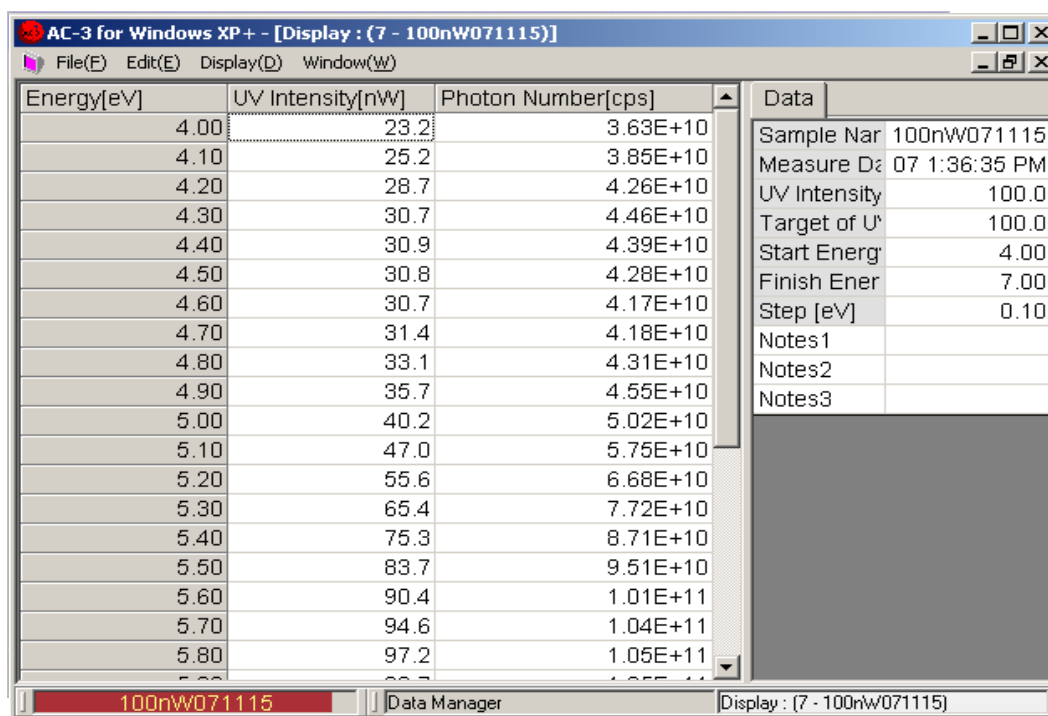

The screenshot shows a software window titled "AC-3 for Windows XP+ - [Display : (7 - 100nW071115)]". The window contains a table with three columns: Energy[eV], UV Intensity[nW], and Photon Number[cps]. The table data is as follows:

Energy[eV]	UV Intensity[nW]	Photon Number[cps]
4.00	23.2	3.63E+10
4.10	25.2	3.85E+10
4.20	28.7	4.26E+10
4.30	30.7	4.46E+10
4.40	30.9	4.39E+10
4.50	30.8	4.28E+10
4.60	30.7	4.17E+10
4.70	31.4	4.18E+10
4.80	33.1	4.31E+10
4.90	35.7	4.55E+10
5.00	40.2	5.02E+10
5.10	47.0	5.75E+10
5.20	55.6	6.68E+10
5.30	65.4	7.72E+10
5.40	75.3	8.71E+10
5.50	83.7	9.51E+10
5.60	90.4	1.01E+11
5.70	94.6	1.04E+11
5.80	97.2	1.05E+11

To the right of the table is a "Data" panel with the following fields:

Sample Name	100nW071115
Measure Date	07 1:36:35 PM
UV Intensity	100.0
Target of UV	100.0
Start Energy	4.00
Finish Energy	7.00
Step [eV]	0.10
Notes1	
Notes2	
Notes3	

The taskbar at the bottom shows the file name "100nW071115", the application "Data Manager", and the window title "Display : (7 - 100nW071115)".

1 2. Print-out

- ① After selecting the desired data [Example;TEST] to print out, start up **File(F)–Print(P)**.
- ② As **Print Setting Box** is displayed, check it and click **OK**.
- ③ **Print Preview Form** shall be displayed.

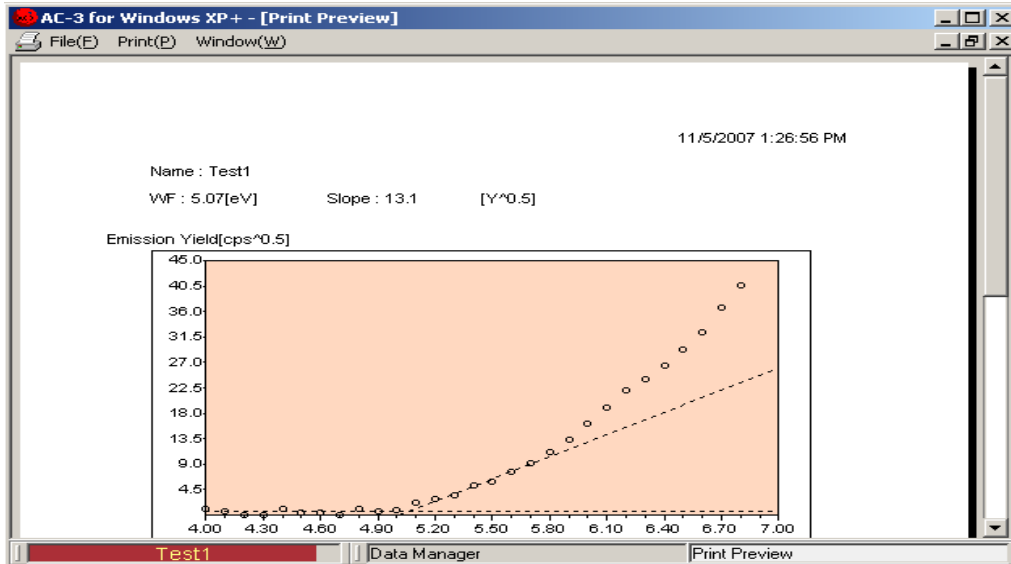

- ④ After checking Graph to display, start up **Print(P)–Print(G)**.

CAUTION

- When print out Single Graph Form directly, there is the case that the condition changed just before could not be reflected.
- The data is printed out by the printer designated normally with OS.
- Print condition is set up with OS.

1 3 . How to finish windows

- ① Repeat the **File(F)–Close(X)** and close all the child form (Menu, Measurement, Data Manager etc) .
- ② Close the **main form** by **File(F)–Close(X)**.
- ③ After changing over POWER SW on the surface panel of main unit from ON(| side) to OFF(0 side), make off the breaker at the rear side of main unit
- ④ Close the main cock of compressed nitrogen.
- ⑤ Close the main cock of compressed air. Or stop the operation of compressor.
- ⑥ When water is deposited in MIST SEPARATOR, turn DRAIN COCK to the right and drain it out.
After drain out, be sure to close DRAIN COCK.
- ⑦ Finish Windows and stop personal computer, display and printer.



1 4 .Other function

14-1.Data Manager

When start up AC-3 for Windows, this shall be displayed.

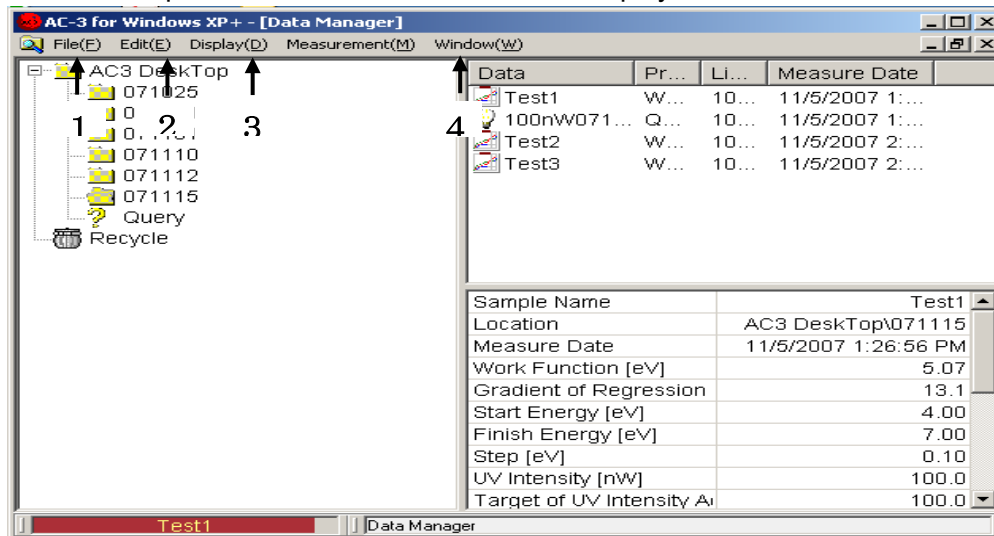

14-1-1.File(F)

- ① **Open(O)** : Open the Data File.
- ② **Create Folder(W)** : New Folder is made up.
- ③ **Save Data(A)** : A part of the measurement data is saved as CSV form.
- ④ **Data base Import** : Data base is imported under the Folder.



CAUTION

When import other thing than Data base exported from AC-3 for Windows, Data base has the possibility to break down.

- ⑤ **Data base Export** : Export Measurement Data or Folder as Data base.
- ⑥ **Data base Repair and Conditioning** : This makes the Repair and Conditioning of Data base.
- ⑦ **Print(P)** : Print the Data File.
- ⑧ **Delete(D)** : Delete the Data File or Folder.
- ⑨ **Rename(R)** : Change Measurement Data or re-name the Folder.
- ⑩ **Close(X)** : Close the form.

14-1-2. Edit (E)

- ① **Return(U)** : Put the moved away Data File or Folder where it was.
- ② **Cut(X)** : Cut out Data File or Folder.
- ③ **Copy(C)** : Copies Data File or Folder. Also designate light intensity correction coefficient data.
- ④ **Paste(P)** : Pastes cut out or copied data below the folder. Or correct Work Function data by Light intensity correction coefficient appointed by copy.
- ⑤ **Select All(A)** : Make the data file all inside of folder or folder itself active.

⑥ **Search(S)** : Search Data File. Input searching conditions and click the searching start box. When click the button, the searching will start. The searching result is filed in **Query** and displayed in **Data Manager**.

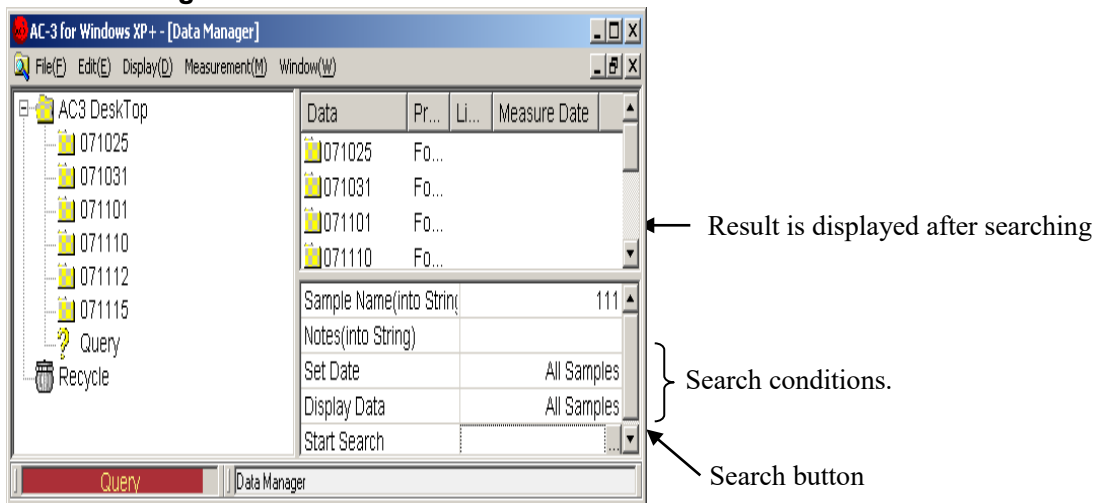

14-1-3. Display(D)

- ① **Status Bar(S)** : This changes over the appear/disappear of Status Bar.
- ② **Refresh Data(D)** : Update the latest information.

14-1-4. Window(W)

- ① **Cascade Display** : Displays windows on piling.
- ② **Tile Vertical Display** : Displays window with vertical line.
- ③ **Tile Horizontal Display** : Displays window with horizontal line.
- ④ **Window** : This displays the form to be opened now.

14-2.Display

Make Data file desired to display **Data Manager** at active condition and it shall be displayed or by starting up **File(F)-Open(O)** by making double click for icon of Data file desired to display.

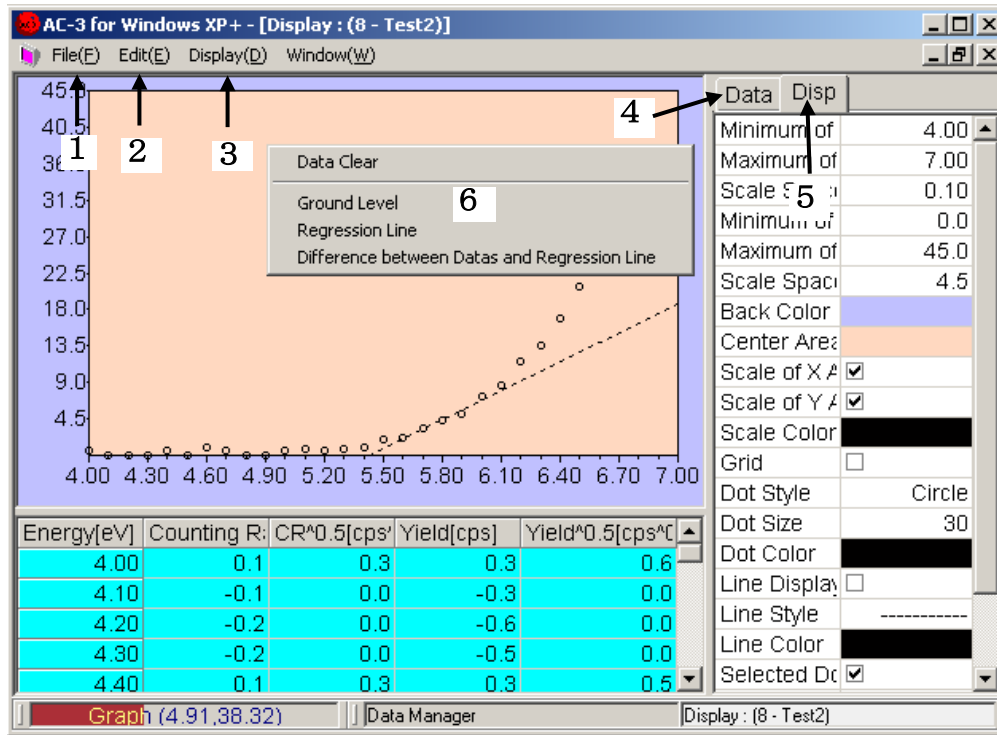

14-2-1. File(F)

- ① **Print(P)** : Can print out.



CAUTION

When print without finishing the form after changing Graph condition, there is the case that the change will not work. After close once, print out.

14-2-2. Edit(E)

- ① **Copy(C)** : Copies graph, table and status on clipboard.

14-2-3. Display(D)

- ① **Graph(G)** : Switches display On/Off of graph.

14-2-4.Data tabs

- ① **Power Number** : Change the power number of vertical line.
- ② **WF Line Display** : Change over appear/disappear of Regression Line.
- ③ **GL line Display** : Change over appear/disappear of grand line.
- ④ **Display of Difference between Data and GL line** : Change over the calculation method of ground level(Normally not checked).

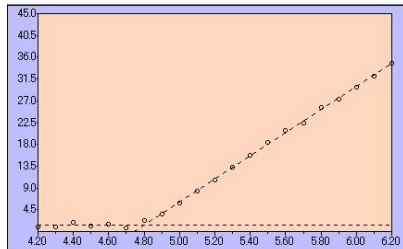

Not checked

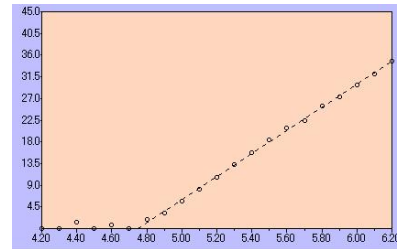

Checked

- ⑤ **Notes** : Inputs notes

14-2-5.Disp tab

- ① X Axis : Minimum, Maximum, Scale Space.
- ② Y Axis : Minimum, Maximum, Scale Space.
- ③ Back Color : Setting the back color
- ④ Color of indication part : Setting the color of indication part.
- ⑤ Scale of X Axis/Y Axis : Appear/Disappear of scale.
- ⑥ Scale Color : Setting the scale color
- ⑦ Grid : Appear/Disappear of grid
- ⑧ Dot : Style, Size, Color.
- ⑨ Line : Regression Line Style, Size, Color.
- ⑩ Selected Dot : Appear/Disappear of Dot when select Ground level and Regression line, Style, Size and Color.

14-2-6.Pop up menu

- ① **Data Clear**
Clear up Ground Level and Regression Line.

② Difference between Data and Regression Line

Make the different portion between regression line and measurement data as new data file. A sample name of different portion data will be (Original sample name) _Dif.

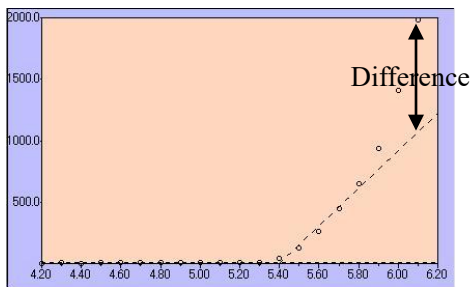

Before making different portion

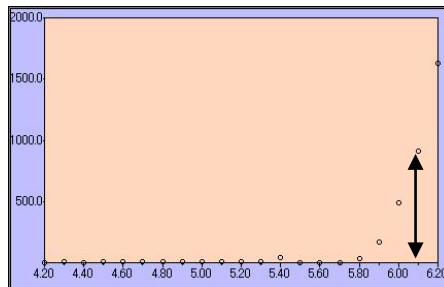

After making different portion

14-3. Print Form

Make the data file desired to print out at active condition by Data Manager and it is displayed by selecting the print.

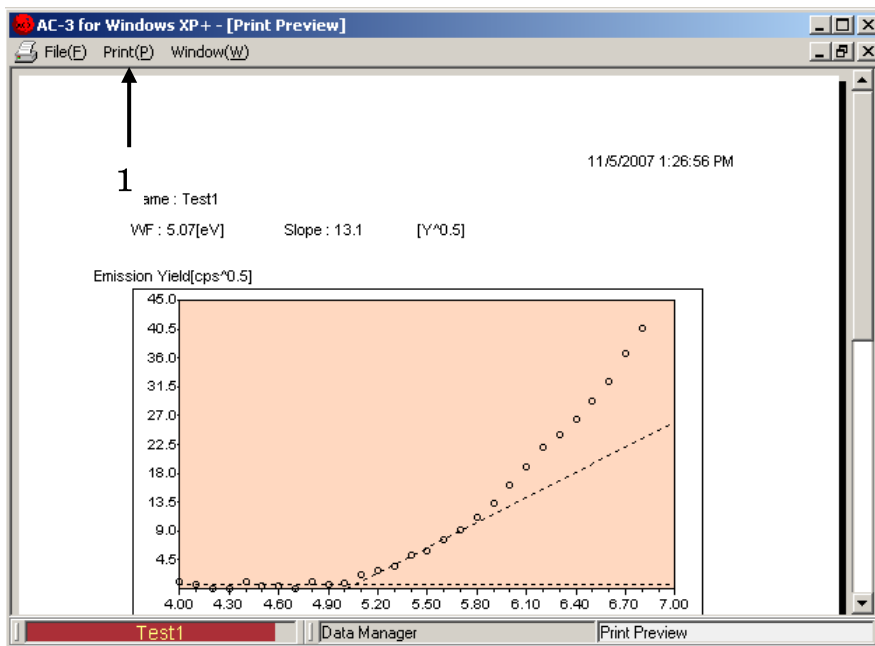

14-3-1. Print(P)

- ① **Print Setting(S)** : This can check the printing condition. Now the set printer shall start from OS.
- ② **Print(G)** : Start printing.

14-4.Main Form

This is displayed when close all the other forms.

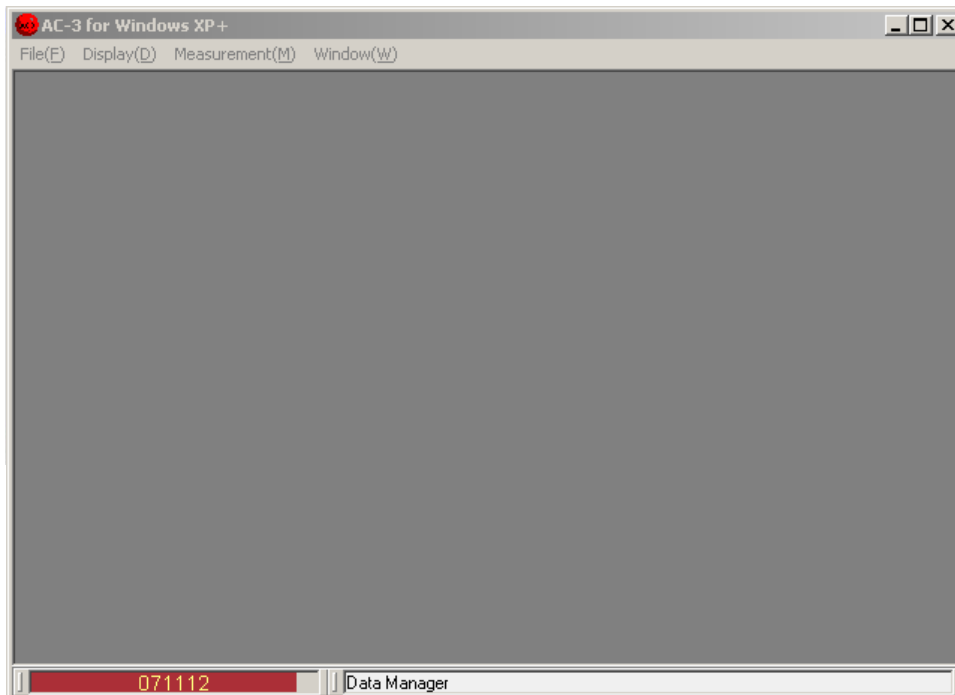

14-4-1.Display (D)

- ① **Data Manager(D)** : This displays Data Manager Form.
- ② **Font** : This can change the Font of display.



When change Font inadvertently, there will be the possibility of making error.

14-5.Back up of Data base

It is recommended to make the back up data of ac3.mdb file regularly.

The "ac3.mdb" is the data base stored with the measurement data of AC-3. At an initial condition, it is located in C:¥Program Files ¥AC-3.

— Consumable parts replacement method —

Index

1.	General	1
2.	Caution	1
3.	How to replace the detector	2
4.	How to replace the UV lamp	5
5.	Replacement of Photomultiplier.....	7
6.	Maintenance of compressed air piping system...	10

1. General

This manual describes the maintenance and replacement method of the consumable spare parts (detector, UV lamp, photomultiplier and dry air generator)

Read instruction manual for AC-3 and that of AC-3 for Windows carefully before performing maintenance or replacement of spare parts.

2. Caution



- Before doing the maintenance work, turn off the breaker at the rear and wait for 1 hour at least. Because, even turning off the power, lamp and other parts may be still hot, and it may injure the hands.
- Before doing the maintenance work, close the valve of compressed air to the dry air generator. And, open the drain cock to release the pressure.
- During the maintenance work, take the necessary protection tools such as eyeglass, gloves and long sleeve ware.
- Do not touch the electron gate of the detector.
- Take care the direction and polarity of lamp when installing.
- Do not give any strong impact on the lamp. It may be damaged and burst.
- Do not touch the lamp directly with hands. It may lose the life of the lamp.
- Do not touch the edge of photomultiplier.

3. How to replace the detector

3-1. Replacement frequency

When the anode of the open counter which is the detector of AC-3 becomes dirty, it makes the serious problem on the measurement.

So, if the condition, example, the PC shows [the trouble happens on the detector], low detection efficiency, large noise or fluctuation of the measurement value, are found, replace the detector. The replacement frequency is depending upon the frequency of use, but the standard life time of the detector is 1 year.

The detector exchanged can e restored by performing overhaul, so if necessary, ask Riken Keiki for overhaul.

3-2. Appearance and caution

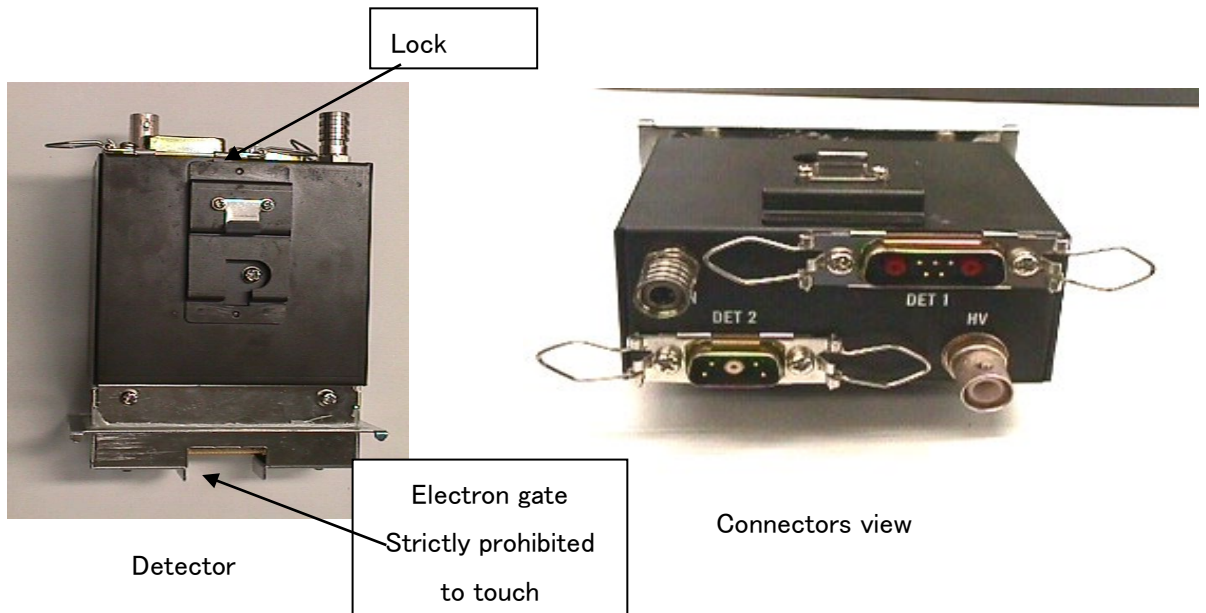

CAUTION

- Before doing the maintenance work, turn off the breaker at the rear side of main unit. If not, it may receive electrical shock.
- Use protection tools like the long sleeve cloth and gloves during maintenance work.
- Do not touch the electron gate of the detector.

3-3. Replacing the detector

3-3-1. Take off the existing detector.

- ① Prepare the cover of detector, detector bag and detector case.



Detector Cover



Detector Bag



Detector Case(Opened)



Detector Case(Closed)

- ② Open the maintenance door 2.
- ③ Take off the cables.
- ④ Release the rock.
- ⑤ Pull up the detector part and remove it.

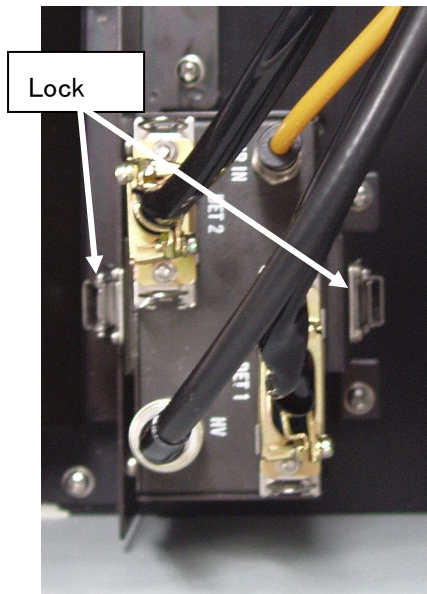

The detector installed to the main unit.



All cables and locks were removed from the detector.



The main unit after removing the detector.

- ⑥ Put the detector cover to the detector removed.

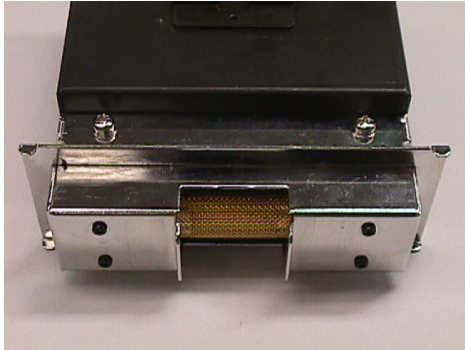

The detector without the cover.



The detector with the cover.

- ⑦ Put the detector in to the detector bag, and keep it in the detector case.

3—3—2. Installing the new detector

- ① Take the new detector from the detector bag and case. (Keep the detector bag and case for next use.)
- ② Remove the detector cover.
- ③ Install the detector.
- ④ Rock the detector.
- ⑤ Connect the cables.

4. How to replace the UV lamp

4-1. Replacement frequency

If the lamp is out of order or unstable, replace it. The standard life time for the lamp is 1500 hours.

4-2. Appearance

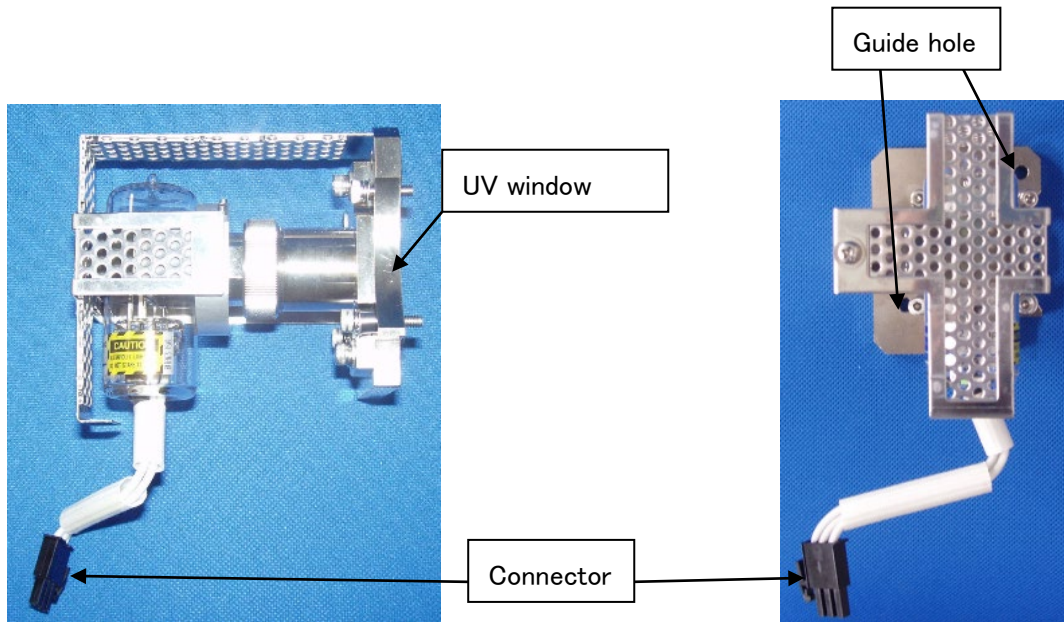

UV lamp

⚠ CAUTION

- Before doing the maintenance work, turn off the breaker and wait for 1 hour at least. Because, even turning off the power, lamp and other parts may be still hot, and it may injure the hands.
- Take care the direction and polarity of lamp when installing.
- Do not give any high impact to the lamp. It may be damaged or burst.
- Use protection tools like the eyeglass, long sleeve cloth and glove when replacing the lamp.
- Do not touch the lamp by hands, it may lose the life of the lamp.
- When turn on the lamp, install the lamp cover to the lamp house and close the lamp maintenance door in advance.
- When open the lamp maintenance door for the confirmation at powered condition, be sure to use protective tools such as ultraviolet rays protective mask, heavy long sleeve cloth, gloves and so on not to get the ultraviolet rays. Also do not touch the lamp house at this point since there is a danger to burn the hands.

4-3. Replacing the UV lamp

- ① Open the maintenance door 3.
- ② Loosen 4 guide screws with ball-point screwdriver supplied as accessories.

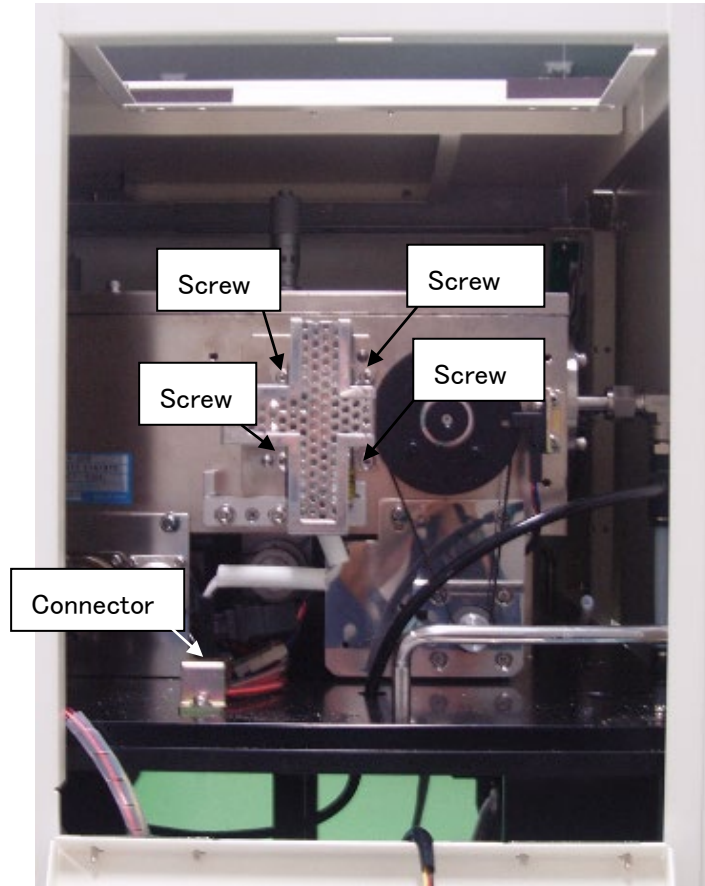

- ③ Take off the connector.
- ④ Remove existing UV lamp.
- ⑤ Prepare the new lamp.
- ⑥ Install the new lamp by matching up the guide pins with guide holes and tighten screws.

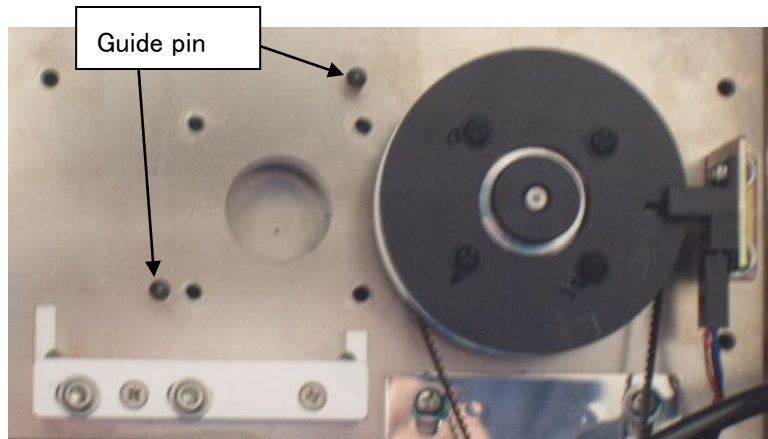

- ⑦ Install the connector

5. Replacement of photomultiplier

5—1. Replacement frequency

The expecting life time for this photomultiplier is approx 5 years.

5—2. Appearance



CAUTION

- Before doing the maintenance work, turn off the breaker and wait for more than 1 hour.
- Keep mounting direction and polarity of photomultiplier as original position.
- Do not give any high impact to the photomultiplier. It may be bursted by breakage.
- Use protection tools like protective mask, heavy long sleeve cloth and gloves when handling the photomultiplier.

5-3. Replacing the photomultiplier

- ① Open the maintenance door 4.
- ② Take off the cable and connector.

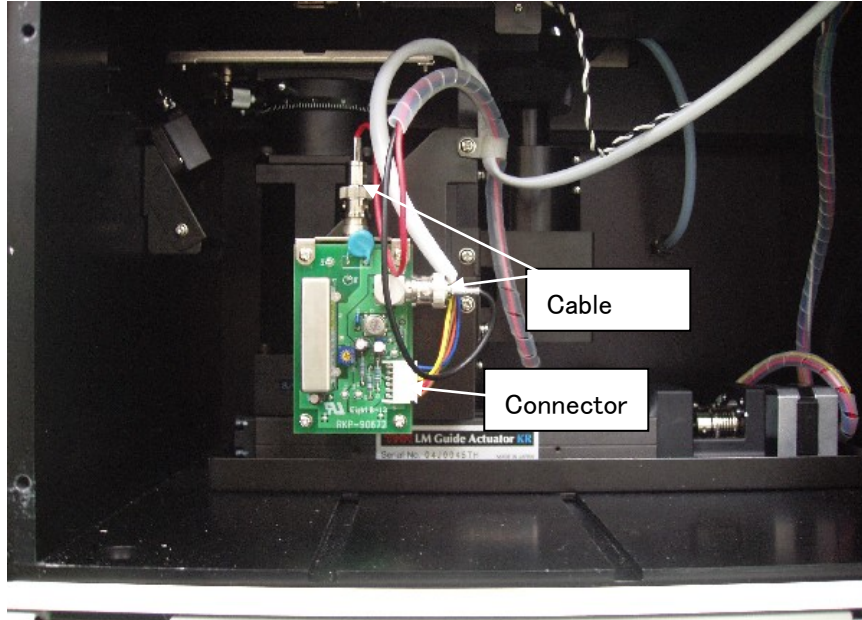

- ③ Loosen the screw and remove the cover.

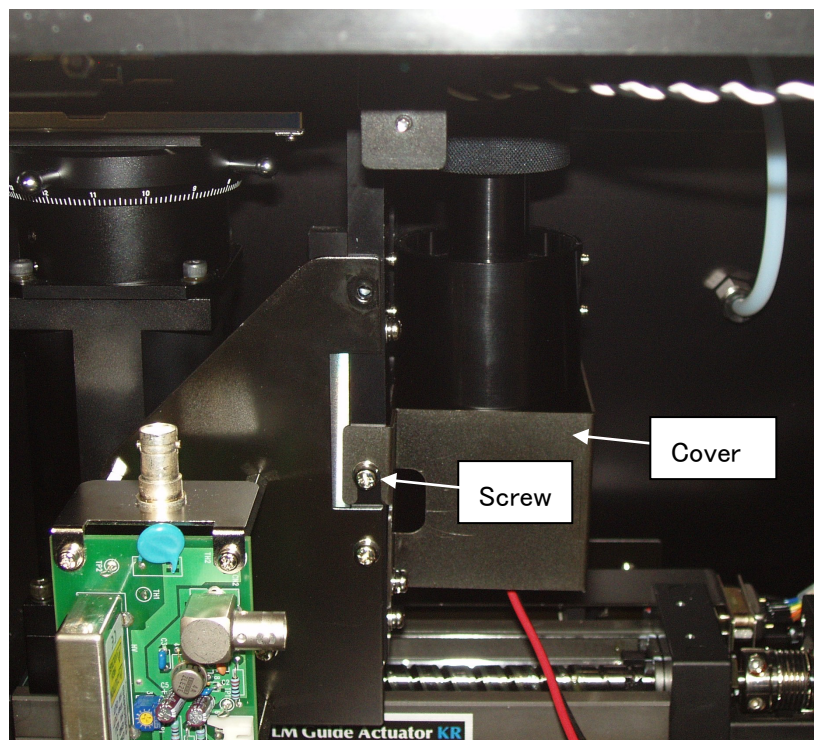

- ④ Take off the knurling screw

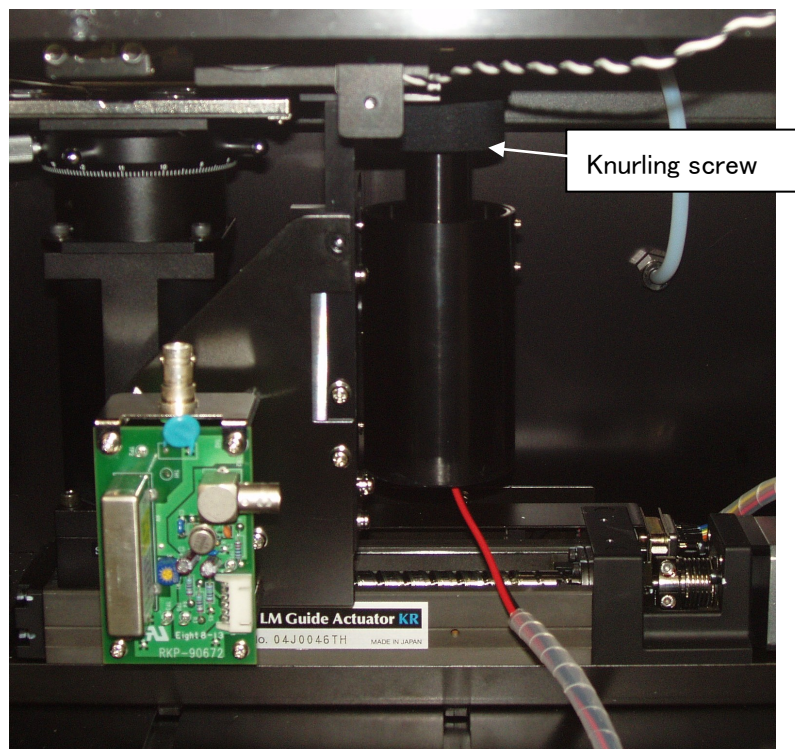

- ⑤ Install the new photomultiplier.
- ⑥ Connect cable and connector.

6. Maintenance of compressed air piping system

6-1 Maintenance frequency

The mist separator and micro mist separator must be maintained every 2 years or if the pressure drop by 0.1 Mpa. In case of dew point checker, it must be maintained every 2 years or if the green color turns pale, it must be replaced.

The replacement frequency of membrane air dryer is every 4 years or if it loses the capacity of dehumidifier or the color of the dew point checker turns to yellow, replace it.

6-2 Explanation of piping system

The compressed air supplied from the rear of the unit is dried and supplied to the detector.

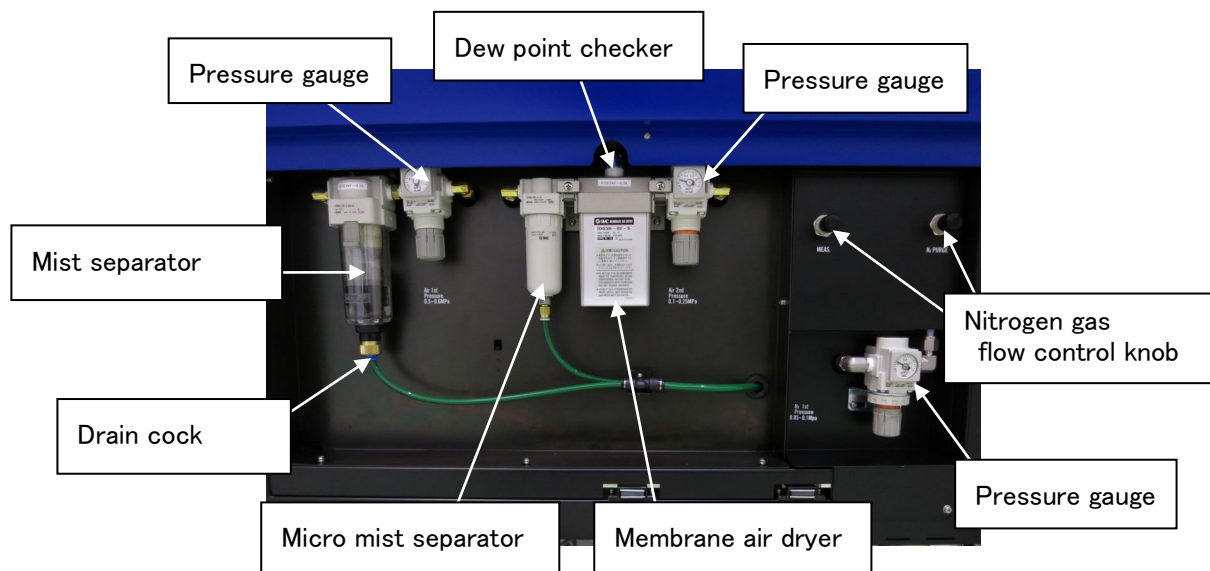

※For the details of maintenance work of this piping system, contract Riken Keiki CO., Ltd.