



PT0E-13523

**Portable Multi-Gas Monitor**  
**GX-6000**  
**Operating Manual**  
**(PT0-135)**

**RIKEN KEIKI Co., Ltd.**

2-7-6 Azusawa, Itabashi-ku, Tokyo, 174-8744, Japan

Phone : +81-3-3966-1113

Fax : +81-3-3558-9110

E-mail : [intdept@rikenkeiki.co.jp](mailto:intdept@rikenkeiki.co.jp)

Web site : <https://www.rikenkeiki.co.jp/>

# Contents

1 Outline of the Product .....	4
Preface.....	4
Purpose of use.....	4
Checking gases to be detected .....	5
Definition of DANGER, WARNING, CAUTION and NOTE .....	6
Method of confirmation for Standards and Explosion proof specification.....	6
2 Important Notices on Safety.....	7
2-1. Danger cases .....	7
2-2. Warning cases.....	8
2-3. Precautions.....	9
2-4. Safety information .....	12
3 Product Components .....	14
3-1. Main unit and standard accessories .....	14
3-2. Names and functions for each part.....	18
4 Alarm Activation.....	23
4-1. Gas alarm activation .....	23
4-2. Fault alarm activation .....	26
4-3. Panic alarm.....	27
4-4. Man-down alarm.....	28
5 How to Use .....	29
5-1. Before using the gas monitor .....	29
5-2. Preparation for start-up .....	29
5-3. How to start the gas monitor .....	37
5-4. Air calibration.....	40
Attaching the CO <sub>2</sub> removal filter (CF-284) (only for the specification targeting CO <sub>2</sub> for detection) .....	40
Attaching the activated carbon filter (only for the specification targeting VOC for detection) .....	41
Air calibration procedure .....	43
5-5. Setting the CAL CODE of the Pre-Filter Tube(Only for the specification with VOC<10.0eV>sensor) .....	45
5-6. How to detect .....	47
5-7. Power-off .....	55
6 Setting Procedure .....	56
6-1. Display setting (DISP mode) flow.....	56
6-2. Display setting .....	61
6-3. User mode setting .....	78
7 Maintenance.....	85
7-1. Maintenance intervals and items .....	85
7-2. Calibration (CAL mode).....	87
7-2-1. Preparation for calibration .....	87
7-2-2. Entering CAL mode .....	88
7-2-3. Air calibration (AIR CAL) .....	89
7-2-4. AUTO CAL .....	91
7-2-5. SINGLE CAL .....	93
7-2-6. TUBE CAL (only for the specification with VOC<10.0eV>sensor ) .....	94
7-2-7. BUMP TEST .....	97
7-3. How to clean.....	99
7-4. Parts replacement .....	100
7-4-1. Gas inlet filter replacement .....	100
7-4-2. Sensor filter replacement .....	101
7-4-3. Sensor replacement .....	102
7-4-4. VOC sensor maintenance .....	104
7-4-5. Regular replacement parts .....	107
8 Storage and Disposal.....	109
8-1. Procedures to store the gas monitor or leave it for a long time.....	109
8-2. Procedures to use the gas monitor again .....	109
8-3. Disposal of products.....	110
9 Troubleshooting.....	111
9-1. Abnormalities on unit.....	111
9-2. Abnormalities of readings.....	113
10 Product Specifications.....	114

10-1. List of specifications .....	114
10-2. List of accessories.....	117
11 Appendix .....	118
11-1. Calibration history/various trend/event history functions .....	118
11-2. Definition of terms.....	120
11-3. List of gases for reading VOC .....	121

---

# 1

---

# Outline of the Product

## Preface

Thank you for choosing our portable multi-gas monitor GX-6000 (hereinafter referred to as "gas monitor"). First of all, please check that the model number of the product you purchased matches the model number of the product targeted by this manual.

This manual contains handling methods and specifications for proper use of this product. Not only the first-time users but also the users who have already used the product must read and understand this manual before using it.

Note that the contents of this manual are subject to change without notice for product improvement. Also, any copying or reproduction of this manual, in whole or in part, without permission is prohibited.

Regardless of warranty period, we shall not make any indemnification for accidents and damage caused by using this gas monitor.

Make sure to read the warranty policy specified on the warranty.

## Purpose of use

This product is a pump suction type multi-gas monitor that enables simultaneous monitoring of up to six different gases: oxygen in the air, combustible gas <%LEL>, toxic gases (carbon monoxide and hydrogen sulfide), and two of gases such as volatile organic compound, sulfur dioxide, etc. detected by the variety of smart sensors that are designed for a specific target gas detection. The combustible gases detected by this gas monitor are general combustible gases used in ordinary factories, oil tankers, etc., that is HC (displayed in isobutane conversion) or CH<sub>4</sub> (methane).

Note that detection results of the gas monitor are not intended to guarantee life or safety in any way.

The gases to be detected varies by the sensors installed in the gas monitor. Check the gases to be detected before use and conduct gas detection properly in accordance with purposes.

Check the gases to be detected by your GX-6000 in 'Checking gases to be detected' (P. 5).

# Checking gases to be detected

The gases to be detected varies by the sensors installed in the gas monitor.  
 Check the gases to be detected by your GX-6000 with the nameplate attached to the side of the product before use.

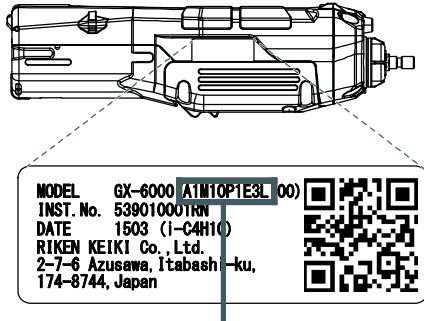

Check the gases to be detected with the product code

**A** ○ ○ ○ ○ ○ ○ ○ ○ ○ ○  
 (Fixed) ① ② ③ ④ ⑤ ⑥ ⑦ ⑧ ⑨

<Base sensor>

Position	Specification	Symbol
①	Combustible gas (HC) <%LEL> sensor	H: Available (HC)
		M: Available (CH <sub>4</sub> )
		0: None
②	Oxygen (O <sub>2</sub> ) sensor	1: Available (O <sub>2</sub> )
		0: None
③	Hydrogen sulfide (H <sub>2</sub> S) sensor	1: Available (H <sub>2</sub> S)
		0: None
④	Carbon monoxide (CO) sensor	1: Available (CO)
		0: None

<Smart sensor>

Position	Specification	Symbol	
⑤⑥	Volatile organic compound (VOC) <10.6eV/ppb> sensor	P1	
	Volatile organic compound (VOC) <10.6eV/ppm> sensor	P2	
	Volatile organic compound (VOC) <10.0eV> sensor	P3	
	Sulfur dioxide (SO <sub>2</sub> ) sensor	E1	
	Nitrogen dioxide (NO <sub>2</sub> ) sensor	E2	
	Hydrogen cyanide (HCN) sensor	E3	
	⑦⑧	Ammonia (NH <sub>3</sub> ) sensor	E4
		Chlorine (Cl <sub>2</sub> ) sensor	E5
		Phosphine (PH <sub>3</sub> )	E6
		Carbon dioxide (CO <sub>2</sub> ) <vol%> sensor	D1
	Combustible gas (HC) <%LEL/vol%> sensor	D2	
	Combustible gas (CH <sub>4</sub> ) <%LEL/vol%> sensor	D3	
	Carbon dioxide (CO <sub>2</sub> ) <ppm> sensor	D4	
	—	00	



<Battery>

Position	Specification	Symbol
⑨	Lithium ion battery	L
	Dry alkaline battery	D

Example) When “1M10P1E3L” is indicated, the gases to be detected are “O<sub>2</sub>, CH<sub>4</sub> <%LEL>, H<sub>2</sub>S, VOC (ppb) and HCN”, battery type is Lithium ion battery.

## Definition of DANGER, WARNING, CAUTION and NOTE

Throughout this manual, the following indications are used to ensure safe and effective work.

 <b>DANGER</b>	Indicates that improper handling may cause death or serious damage on life, health or assets.
 <b>WARNING</b>	Indicates that improper handling may cause serious damage on health or assets.
 <b>CAUTION</b>	Indicates that improper handling may cause minor damage on health or assets.
<b>NOTE</b>	Indicates advice on handling.

## Method of confirmation for Standards and Explosion proof specification

This instrument has some specification depends on standard and explosion proof certificate. Please confirm the detector specification before using. Please refer Declaration of Conformity that is at the end of this manual if you have CE/UKCA marking type. You can confirm instrument specification to see name plate as follows.

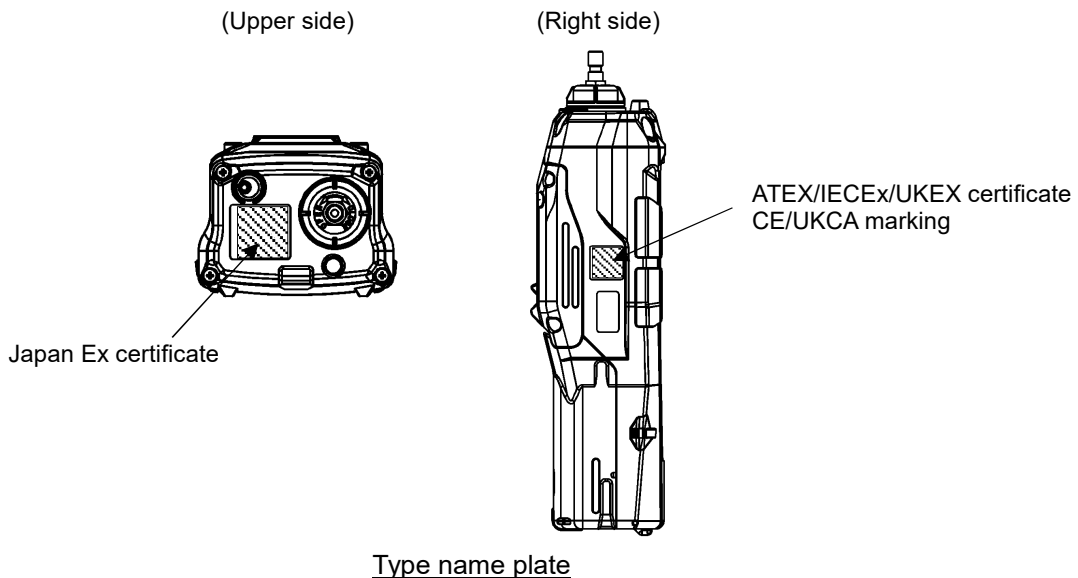

---

## 2

---

# Important Notices on Safety

To maintain the performance and use the gas monitor safely, observe the following instructions of DANGER, WARNING and CAUTION.

## 2-1. Danger cases



### DANGER

#### About use

- While conducting measurement in a manhole or confined space, do not lean over or look into the manhole or closed space. It may lead to dangers because oxygen-deficient air or other gases may blow out.
- Oxygen-deficient air or other gases may be discharged from the gas exhausting outlet. Never inhale the air or gases.
- High-concentration (100 %LEL or higher) gases may be discharged from the gas exhausting outlet. Never use fire near it.



### WARNING

- If any abnormality is found on the gas monitor, promptly contact RIKEN KEIKI. Visit our Web site to find your nearest RIKEN KEIKI office.  
Web site: <https://www.rikenkeiki.co.jp/>

## 2-2. Warning cases



### WARNING

- **Sampling point pressure**  
The gas monitor is designed to draw gases around it under the atmospheric pressure. If excessive pressure is applied to the gas inlet and outlet of the gas monitor, detected gases may leak out from its inside and may cause dangerous conditions. Be sure that excessive pressure is not applied to them while used.
- **Handling of sensor**  
Never disassemble the electrochemical type sensor or galvanic cell type sensor. Inside electrolyte may cause severe skin burns if it contacts skin. Also, it may cause blindness if it contacts eyes. If electrolyte is adhered on your clothes, that part on your clothes is discolored or its material is decomposed. If contact occurs, rinse the area immediately with a large quantity of water.
- **Fresh air adjustment in the atmosphere**  
When the fresh air adjustment is performed in the atmosphere, check the atmosphere for freshness before beginning the adjustment. If interference gases exist, the adjustment cannot be performed properly, thus causing erroneous detection and leading to dangers when the gas leaks.



### WARNING

- **Response to gas alarm**  
Issuance of a gas alarm indicates that there are extreme dangers. Take proper actions based on your judgment.
- Panic alarm and man-down alarm**
- Panic and man-down alarms are intended to assist users and people around in making a decision and not intended to guarantee life or safety. Do not depend only on this function to use the gas monitor.  
(Normally the man-down alarm is set to OFF and unavailable. To use this function, please contact RIKEN KEIKI.)
  - If a panic or man-down alarm is triggered, the people around must take an appropriate action after confirming the situation.
- Battery level check**
- Before use, check that there remains sufficient battery power. When the gas monitor is used for the first time or is not used for a long period, the batteries may be exhausted. Replace them with new ones before use.
  - If a low battery voltage alarm is triggered, gas detection cannot be conducted. If the alarm is triggered during use, turn off the power and promptly charge or replace the batteries in a safe place.
- Others**
- Do not throw the gas monitor into fire.
  - Do not wash the gas monitor in a washing machine or ultrasonic cleaner.
  - Do not block the buzzer sound opening. No alarm sound can be heard.
  - Do not remove batteries while the power is ON.



## 2-3. Precautions



### CAUTION

- Do not use the gas monitor where it is exposed to oil, chemicals, etc. Do not submerge the gas monitor under water on purpose.
- Do not use in a place where the gas monitor is exposed to liquids such as oil and chemicals.
- The gas inlet and outlet are not water-proof. Be careful not to let water such as rainwater get into these parts. Because this may cause trouble and gas cannot be detected.
- Do not place the gas monitor where water or dirt gets accumulated. The gas monitor placed at such a location may malfunction due to water or dirt that gets into the buzzer sound opening, gas inlet, etc.
- Note that drawing in dirty water, dust, metallic powder, etc. will significantly deteriorate the sensor sensitivities. Be very careful when the gas monitor is used in an environment where these elements exist.
- Do not use the gas monitor in a place where the temperature drops below -20 °C or rises over 50 °C.
- The operating temperature of the gas monitor is -20 - +50 °C. Do not use the gas monitor at higher temperatures, humidities and pressures or at lower temperatures than the operating range.
- Avoid long-term use of the gas monitor in a place where it is exposed to direct sunlight.
- Do not store the gas monitor in a sun-heated car.
- Observe the operating restrictions to prevent condensation inside the gas monitor. Condensation formed inside the gas monitor causes clogging or gas adsorption, which may disturb accurate gas detection. Thus, condensation must be avoided. In addition to the installation environment, carefully monitor the temperature/humidity of the sampling point to prevent condensation inside the gas monitor. Please observe the operating restrictions.
- Do not use a transceiver near the gas monitor.
- Radio wave from a transceiver or other radio wave transmitting device near the gas monitor may disturb readings. If a transceiver or other radio wave transmitting device is used, it must be used in a place away from the gas monitor where it disturbs nothing.
- Do not use the gas monitor near a device that emits strong electromagnetic waves (high-frequency or high-voltage devices).
- Verify that the pump operation status display is rotating before using the gas monitor. If the pump operation status display is not rotating, gas detection cannot be performed properly. Check whether the flow rate is lost.



## CAUTION

- Verify that the operation status display is blinking before using the gas monitor. If the operation status display is not blinking, gas detection cannot be performed properly.
- About sensor
- Some sensors will respond to a gas other than their target gas. The table below indicates some of the gases that will cause an increased reading for the affected sensor. For example, if you are attempting to detect HCN and H<sub>2</sub>S is also present, the instrument's HCN reading will be higher than the environment's actual HCN level.

Examples of interference gases that cause increased readings

Principle of sensor used in GX-6000 (Target gas)	/	Interference gas
Electrochemical(HCN)	/	H <sub>2</sub> S
Electrochemical(HCN)	/	SO <sub>2</sub>
Electrochemical(HCN)	/	C <sub>2</sub> H <sub>2</sub>
Electrochemical(SO <sub>2</sub> )	/	H <sub>2</sub>
Electrochemical(SO <sub>2</sub> )	/	CO
Electrochemical(CO)	/	H <sub>2</sub>
Electrochemical(Cl <sub>2</sub> )	/	SO <sub>2</sub>
Electrochemical(Cl <sub>2</sub> )	/	HCl
Electrochemical(PH <sub>3</sub> )	/	SO <sub>2</sub>
Electrochemical(PH <sub>3</sub> )	/	HCN
Electrochemical(PH <sub>3</sub> )	/	H <sub>2</sub> S
New ceramic (HC/CH <sub>4</sub> )	/	Combustible gases
Non-dispersive infrared type(HC/CH <sub>4</sub> )	/	Hydrocarbon gases of combustible gases
PID (VOC)	/	VOC

- Some toxic sensors will respond negatively to some gases that may be present along with the target gas. The table below indicates some of the gases that will cause a negative response and a decreased reading for the affected sensor.

Examples of interference gases that cause decreased readings

Principle of sensor used in GX-6000 (Target gas)	/	Interference gas
Electrochemical(H <sub>2</sub> S)	/	NO <sub>2</sub>
Electrochemical(HCN)	/	NO <sub>2</sub>
Electrochemical(NO <sub>2</sub> )	/	SO <sub>2</sub>
Electrochemical(SO <sub>2</sub> )	/	NO <sub>2</sub>
Electrochemical(NH <sub>3</sub> )	/	H <sub>2</sub> S
Electrochemical(PH <sub>3</sub> )	/	NO <sub>2</sub>

- Exposing the catalytic combustible sensor to silicone, halogen gases, or sulfides may shorten the sensor's life or cause malfunctions or inaccurate gas readings. Minimize the sensor's exposure to these gases as much as possible. If exposure occurs, allow the instrument to draw fresh air and confirm that the readings return to fresh air values.
- Exposing the galvanic oxygen sensor to halogen gas or sulfides may shorten the sensor's life or cause malfunctions or inaccurate gas readings. Minimize the sensor's exposure to these gases as much as possible. If exposure occurs, allow the instrument to draw fresh air and confirm that the readings return to fresh air values.
- An oxygen concentration higher than a certain level is required for the new ceramic combustible gas sensor <%LEL> of the gas monitor to correctly detect gases and display concentrations.
- When measuring concentrations of oxygen in inert gases for a long time, the carbon dioxide concentration in the air must be 15 % or less. When the gas monitor is used in the inert gas with a carbon dioxide concentration higher than 15 %, perform measurement in as short time as possible. Using the gas monitor under high concentrations for a long time may shorten the life of the oxygen sensor.
- The CO reading on GX-6000 may increase after being exposed to high concentration of VOC gases. If the reading is not returned to zero, the charcoal filter for CO sensor is required. Contact RIKEN KEIKI for the filter replacement.



## CAUTION

- Be careful when measuring concentrations of Cl<sub>2</sub> and NH<sub>3</sub> at a lower limit of operating temperature (around -20 °C), the response time to the gas may slow down due to the gas characteristic.
- When high concentrations of methane gas, ethane gas, propane gas, etc. are present, the PID type VOC sensor may display "----" in the concentration display section, the lamp may blink, the buzzer may sound, and measurement may become temporarily impossible. Note that in an environment where these gases are present, even if "----" is not displayed on the concentration display, the VOC concentration may not be measured correctly. Note that even if "----" is displayed in the concentration display section of the VOC sensor, sensors that are not affected by anything other than the VOC sensor can continue to measure.

Example of interfering gas where "----" is displayed in the concentration display section of a PID type VOC sensor

Interference gas	/	Gas concentration
Methane	/	≥ 6vol%
Ethane	/	≥ 80vol%
Propane	/	≥ 90vol%

- Never fail to perform a regular maintenance. Never fail to perform a regular maintenance for the gas monitor to ensure safety. Continuing to use the gas monitor without performing maintenance will compromise the sensitivity of the sensor, thus resulting in inaccurate gas detection.
- Others
  - Pressing buttons unnecessarily may change the settings, preventing alarms from activating correctly. Operate the gas monitor using only the procedures described in this operating manual.
  - Do not drop or give shock to the gas monitor. The accuracy of the gas monitor may be deteriorated.
  - Do not use the gas monitor while charging it.
  - Do not jab the buzzer sound opening with a sharp-pointed item. The unit may malfunction or get damaged, allowing foreign matters, etc. to get inside.
  - Do not remove the panel sheet on the LCD display. The dust-proof performance will be deteriorated.
  - Do not affix a label or the like on the infrared communication port. Infrared communications can no longer be conducted.
- Replacement of batteries
  - Turn off the power of the gas monitor before replacing batteries of the battery unit.
  - Replace all of the three batteries with new ones at one time.
  - Pay attention to the polarities of the batteries.
- Usage
  - In a low-temperature environment, the operating time is shortened due to the battery performance property.
  - At low temperatures, the responses of the LCD display may slow down.
  - Perform air calibration under pressure and temperature/humidity conditions close to those in the operating environment and in fresh air.
  - Perform air calibration after the reading is stabilized.
  - If there is a sudden temperature change of 15 °C or more between the storage and operational locations turn on the power of the gas monitor, let it stand for about 10 minutes in a similar environment to the operational location, and perform air calibration in fresh air before using it.
  - When cleaning the gas monitor, do not splash water over it or use organic solvents such as alcohol and benzene on it. The surface of the gas monitor may be discolored or damaged.
  - If the gas monitor is not used for a long time, turn on the power at least once every six months and check that the pump draws in air (about three minutes). The gas monitor, when not activated for a long time, may cease to work because of hardening of the grease in the pump motor.
  - If the gas monitor is not used for a long time, store it after removing the batteries. Battery leaks may result in fire, injury, etc.
  - When using the gas monitor after long-term storage, never fail to perform a calibration. For information on readjustment including calibration, please contact RIKEN KEIKI.

## 2-4. Safety information

The GX-6000 can measure maximum six gases with six sensors.

Standard unit measures four gases with four sensors for general combustible gases(LEL), Oxygen(O<sub>2</sub>), Hydrogen Sulfide(H<sub>2</sub>S) and Carbon Monoxide(CO).

For other remaining two slots are for Smart Sensors which consist of sensor part and circuit board and are connected with apparatus through digital signal output so various sensors. Three different types of detection principle are applied for Smart Sensors and up to two sensors can be installed into the GX-6000.







Gas is sampled by a built-in micro pump.

Either alkaline battery pack "BUD-6000" or lithium-ion battery pack "BUL-6000" can be installed into GX-6000.

Structure of battery unit allows end users to replace it by themselves.

It is supposed to replace the battery unit, alkaline battery, and charge the rechargeable battery at non-hazardous area. Also, Charging BUL-6000 should be done with a specific model, BC-6000 or SDM-6000.

### Specification for safety

GX-6000 Ex code T class	Ambient temperature range for use	Combustible gas sensor	Battery
Ex ia IIB T4 Ga  II1G Ex ia IIB T4 Ga	-20°C to +50°C	Mounted	BUL-6000
Ex ia IIC T4 Ga  II1G Ex ia IIC T4 Ga	-20°C to +50°C	N/A	BUL-6000
Ex ia IIB T4 Ga  II1G Ex ia IIB T4 Ga	-20°C to +50°C	Mounted	BUD-6000 LR6 (TOSHIBA)
Ex ia IIC T4 Ga  II1G Ex ia IIC T4 Ga	-20°C to +50°C	N/A	BUD-6000 LR6 (TOSHIBA)
Ex ia IIB T3 Ga  II1G Ex ia IIB T3 Ga	-20°C to +50°C	Mounted	BUD-6000 MN1500 (DURACELL)
Ex ia IIC T3 Ga  II1G Ex ia IIC T3 Ga	-20°C to +50°C	N/A	BUD-6000 MN1500 (DURACELL)

•Ambient temperature range during battery charging : 0°C to +40°C

### Electrical data

•Power supply of Li-ion battery unit : BUL-6000

Two parallel connected Li-ion cells used in battery pack BUL-6000 are from type Maxell INR18650PB1 or SDI INR18650-15M or SONY US18650VT3.

Um = 250 V.

•Power supply of alkaline battery unit : BUD-6000

Powered by three series connected Alkaline AA batteries, type LR6 manufactured by Toshiba or type MN1500 manufactured by DURACELL.

**Certificate numbers**

- IECEX Certificate number : IECEX PRE 15.0011
- ATEX Certificate number : Presafe15 ATEX6171X
- UK Type Examination Certificate : DNV 22 UKEX 25912X

**List of standards**

- |                    |                      |                        |
|--------------------|----------------------|------------------------|
| •IEC 60079-0:2017  | •EN IEC 60079-0:2018 | •BS EN IEC60079-0:2018 |
| •IEC 60079-11:2011 | •EN 60079-11:2012    | •BS EN 60079-11:2012   |

**Specific conditions of “X”-mark:**

Regarding ATEX specification, the measuring function according to Annex II paragraph 1. 5. 5 of the Directive is not covered by this EU-type examination.

It shall comply with the requirements from the relevant European harmonized standards which provide guidance on the performance of gas detection equipment and safety devices.

The measuring function according to schedule 1, paragraph 24 of the Regulation is not covered in this UK-type examination. It shall comply with the requirements from the relevant UK Designated Standards which provide guidance on the performance of gas detection equipment.

**WARNING**

- DO NOT CHARGE IN HAZARDOUS LOCATION.
- DO NOT CHARGE IT EXCEPT BY GENUINE CHARGER.
- DO NOT REPLACE BATTERY UNIT IN HAZARDOUS LOCATION.
- DO NOT REPLACE DRY BATTERIES IN HAZARDOUS LOCATION.
- DO NOT ATTEMPT TO DISASSEMBLE OR ALTER THE INSTRUMENT.
- USE ONLY WITH CONNECTED ALKALINE AA BATTERIES, TYPE LR6  
MANUFACTURED BY TOSHIBA OR TYPE MN1500 MANUFACTURED BY DURACELL.

INST. No. 0 0 0 0 0 0 0 0 0 0

A B C D E

A: Manufacturing year (0 - 9)

B: Manufacturing month (1 - 9,XYZ for Oct. - Dec.)

C: Manufacturing lot

D: Serial number

E: Code of factory

**RIKEN KEIKI Co.,Ltd.**

2-7-6 Azusawa, Itabashi-ku, Tokyo, 174-8744, Japan

Phone : +81-3-3966-1113

Fax : +81-3-3558-9110 GIII

E-mail : [intdept@rikenkeiki.co.jp](mailto:intdept@rikenkeiki.co.jp)

Web site : <https://www.rikenkeiki.co.jp>

---

**3**

---

---

# Product Components

---

## 3-1. Main unit and standard accessories

Unpack and check the main unit and accessories.  
If any part is missing, contact RIKEN KEIKI.

### Main unit

See '3-2. Names and functions for each part' (P. 18) for names and functions of each part of the gas monitor and LCD display.

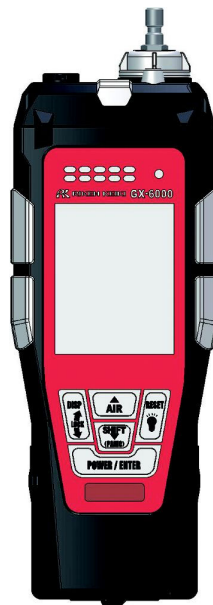

GX-6000 main unit

## Standard accessories

Lithium ion battery unit (BUL-6000)\*  
1 pc

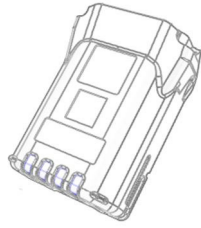

Charger\*  
1 pc

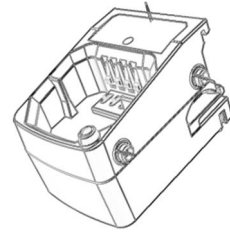

Dry battery unit\*\* (BUD-6000)  
1 pc

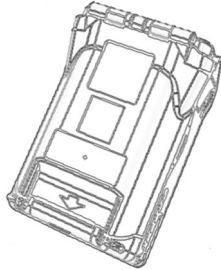

AA alkaline battery\*\*  
3 pcs



Protect cover  
1 pc

Protect the gas monitor from shocks by being hit, etc.



Belt clip  
1 pc  
(3 screws)

The gas monitor can be hung from a belt.

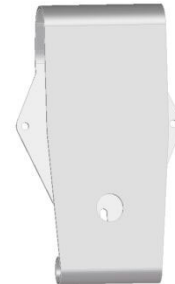

Taper nozzle  
1 pc



Hand strap  
1 pc



LCD protection film  
1 pc

Protect the display from fine scratches.

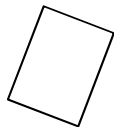

CO<sub>2</sub> removal filter (CF-284)  
1 pc

Provided only for the specification with CO<sub>2</sub> sensor



Carbon filter (CF-8350)  
1pc

Provided only for the specification with VOC sensor

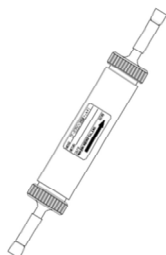

Carbon filter (CF-8501)  
1pc

Provided only for the specification with both of VOC sensor and CO<sub>2</sub> sensor

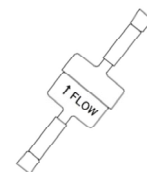

Product warranty

Operating manual

\* / \*\* The lithium ion battery unit / battery charger, or the dry battery unit / alkaline battery are provided.

**NOTE**

- The charger can be attached to a DIN rail to use.  
Use a DIN rail of IEC715 top-hat type TH35.
- Hang the tab of the charger unit on the barb part of DIN rail, and then attach the stopper to the barb part of DIN rail.
- To release, push the stopper downward.

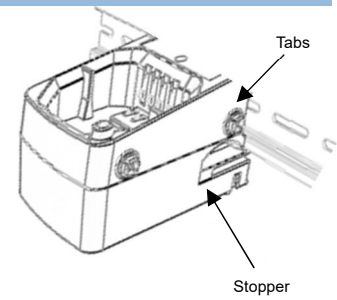



**Optional items (sold separately)**

Lithium ion battery unit (BUL-6000)  
1 pc

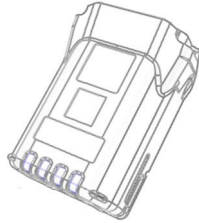

Charger  
1 pc

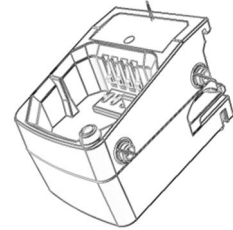

Dry battery unit (BUD-6000)  
1 pc

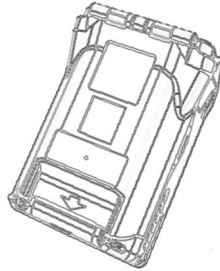

AA alkaline battery  
3 pcs



Gas sampling probe

Gas sampling hose (5 m/10 m/20 m/30 m)

Various filters

Various gas sampling bag

PID-Pre-Filter Tube Benzene (CF-8338)  
1pc(10 tubes)

only for the specification with VOC<10.0eV>sensor

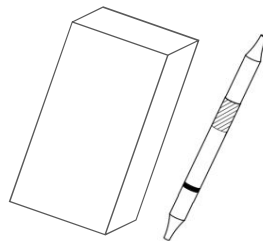

Tube holder (GF-284)  
1pc

only for the specification with VOC<10.0eV>sensor

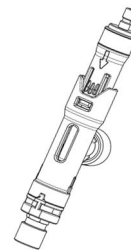

Lamp cleaning kit

Data logger management program

Setting program for list of gases for reading VOC



**CAUTION**

- The gas sampling hose may absorb a small amount of several of the GX-6000's target gases, such as toxic gases, solvents, or VOCs. This absorption causes the target gas reading on the GX-6000 to be lower than the sampled environment's actual gas level.

## 3-2. Names and functions for each part

This section describes names and functions of main unit and battery unit parts and LCD display.

### Main unit

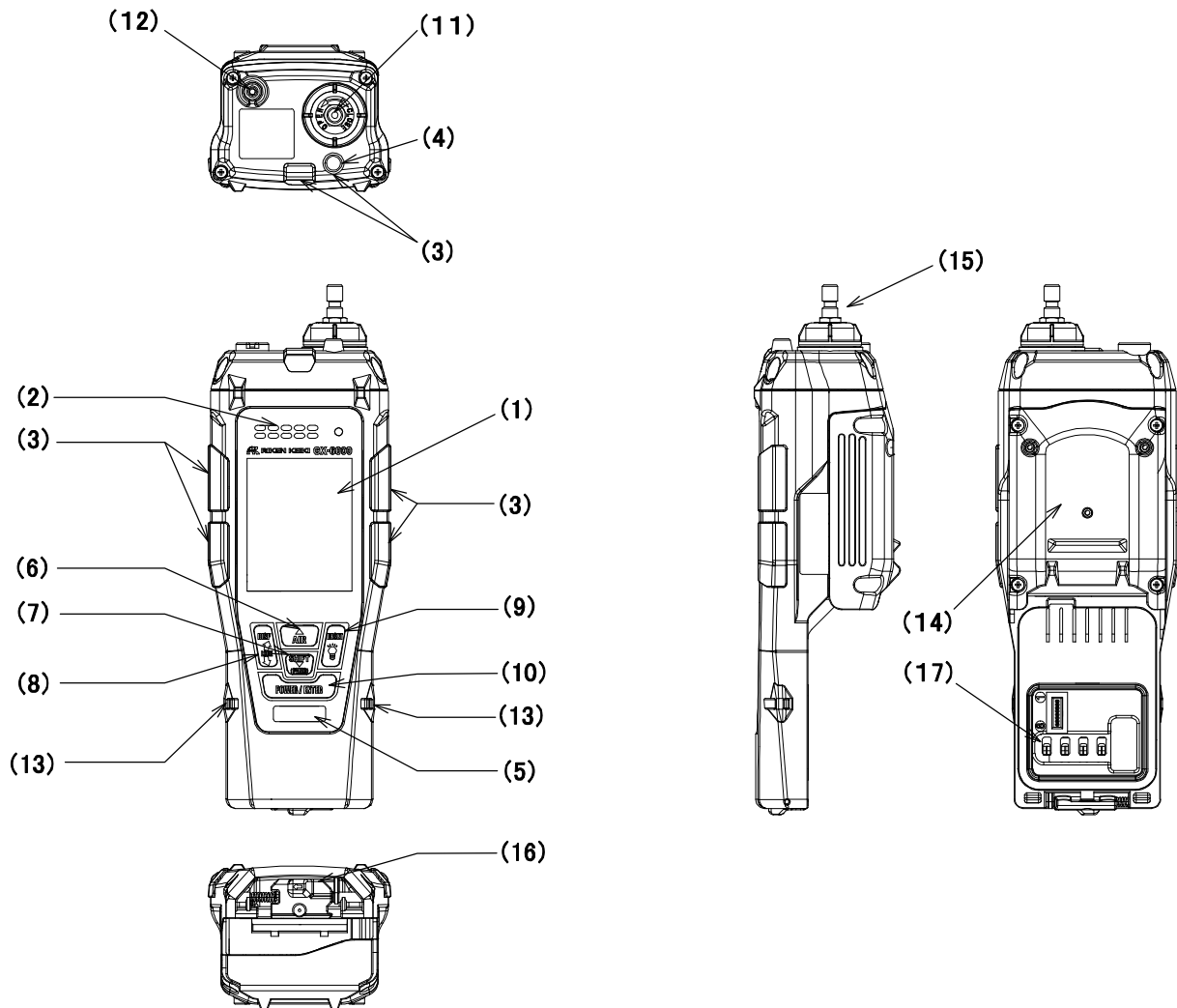

Name	Main function
(1) <b>LCD display</b>	Displays the gas concentration and so on.
(2) <b>Buzzer sound opening</b>	Emits operation and judging sounds. (Do not block it.)
(3) <b>Alarm LED arrays</b>	The red lamp blinks in response to an alarm.
(4) <b>Illumination lamp</b>	Lights up by holding down the  (illumination lamp) button.
(5) <b>Infrared communication port</b>	Used to carry out data communications with a PC when the data logger management program is used.
(6) <b>▲/AIR button</b>	Used to perform air calibration on the detection screen. Or used to move the cursor (>) up in the DISP and user modes.
(7) <b>SHIFT/▼ /(PANIC) button</b>	Used to move the cursor (>) down in the DISP and user modes. In emergency situations, hold down this button to trigger a panic alarm.
(8) <b>DISP/LOCK button</b>	Displays the DISP mode and changes the display. Holding down this button with LCD inversion (P. 74) set locks the display.

Name	Main function
(9) <b>RESET/☞ (illumination lamp) button</b>	Used to confirm and reset an alarm. Holding down this button turns on the upper illumination lamp.
(10) <b>POWER/ENTER button</b>	Turns on/off the power. Or used to confirm selection in the DISP and user modes.
(11) <b>Gas inlet</b>	Draws in a gas. (Do not block it.)
(12) <b>Gas outlet</b>	Exhausts the gas drawn into the gas monitor. (Do not block it.)
(13) <b>Holes for hand strap (2 positions)</b>	Used to attach the provided hand strap.
(14) <b>Sensor cover</b>	Protects the sensor inside. May be opened only when the sensor is to be replaced.
(15) <b>Filter case</b>	Protects the dust filter inside. Do not remove the case except for maintenance and replacement.
(16) <b>Battery unit release lever</b>	Push the lever while sliding it to remove the battery unit.
(17) <b>Battery unit connection terminal</b>	Used to supply power of the battery unit to the gas monitor.



## CAUTION

- Do not jab the buzzer sound opening with a sharp-pointed item. Water, foreign matters, etc. may get inside and cause malfunction or damage.
- Do not remove the panel sheet on the surface. The water-proof and dust-proof performances will be deteriorated.
- Do not affix a label or the like on the infrared communication port. Infrared communications can no longer be conducted.

## NOTE

- In this operating manual, the buttons equipped with multiple functions are described in operational procedures in the following manner.  
Example) POWER/ENTER button is described as follows:
  - POWER button in turning on/off the power
  - ENTER button in confirming settings.

## Battery unit

### <Lithium Ion Battery Unit (BUL-6000)>

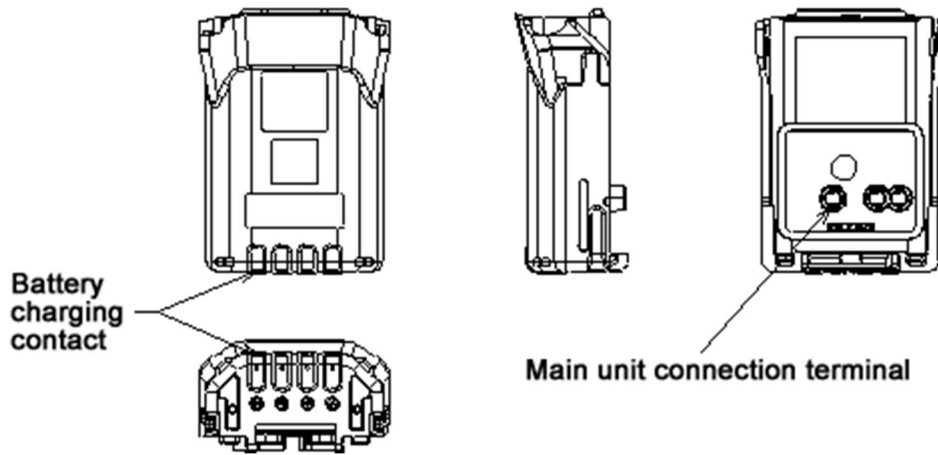

### <Dry Battery Unit (BUD-6000)>

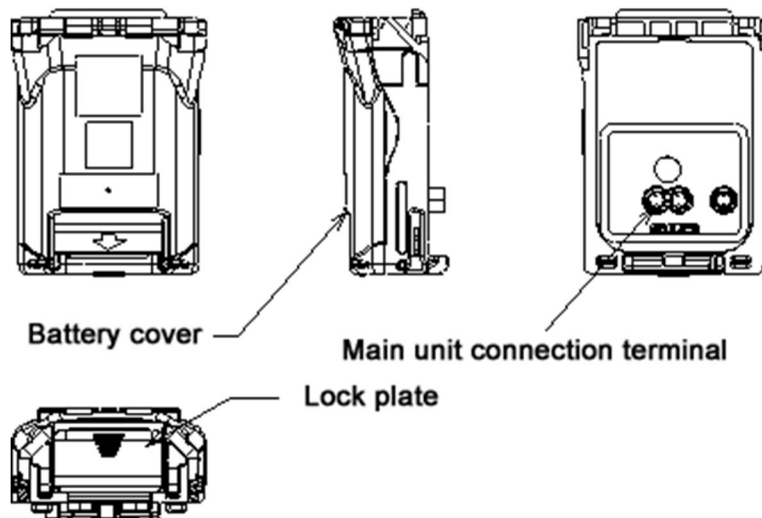

## LCD display

### <Normal Mode>

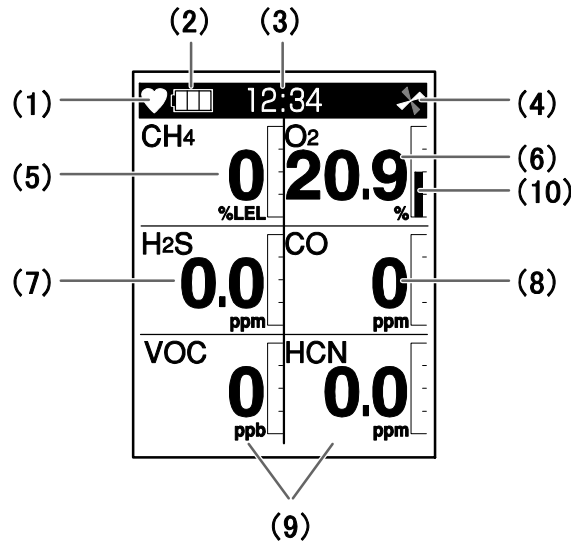

Name	Main function
(1) Operating state display	Displays the operating status. Blinks at a normal state.
(2) Battery level display	Displays the battery level. See 'NOTE' for a guide for battery level.
(3) Clock display	Displays the current time.
(4) Pump operation status display	Displays the drawing status. Rotates at a normal state.
(5) Combustible gas concentration	Displays the gas concentration as numeric output.
(6) Oxygen concentration	
(7) Hydrogen sulfide concentration	
(8) Carbon monoxide concentration	
(9) Gas concentration detected by smart sensor	
(10) Bar display	Displays the gas concentration with bar.

### NOTE

- The gas concentration display positions can be changed. See 'Changing display positions of measured gases' (P. 81) for how to change the display positions.
- The battery level is indicated as follows:
  - Sufficient
  - Low
  - Need charging (replacement of batteries)
 If the battery level further drops, the battery icon starts blinking.

**<Leak Check Mode>**

- The gas monitor is equipped with leak check mode as well as normal mode for combustible gas using the new ceramic sensor. The leak check mode, however, is set to OFF normally and thus unavailable. To use this function, please contact RIKEN KEIKI.
- Leak check full scale value can be selected from 500, 1000, 2000 and 5000 ppm.
- The following figure shows the LCD display in the leak check mode.

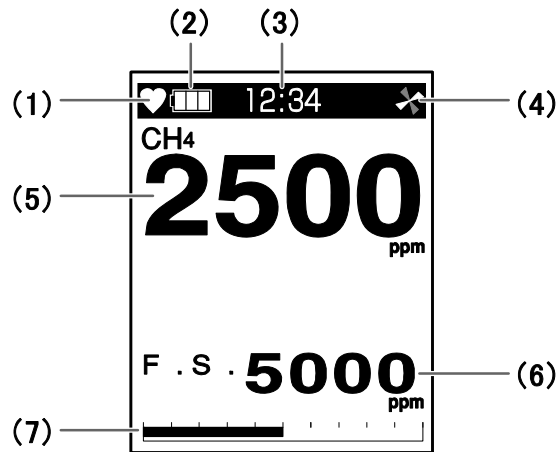

Name	Main function
(1) Operating state display	Displays the operating status. Blinks at a normal state.
(2) Battery level display	Displays the battery level. See 'NOTE' (P. 21) for a guide for battery level.
(3) Clock display	Displays the current time.
(4) Pump operation status display	Displays the drawing status. Rotates at a normal state.
(5) Gas concentration display	Displays the gas concentration as numeric output.
(6) Leak check full scale display	Displays the full scale value to be used in the leak check mode.
(7) Bar display	Displays the gas concentration with bar.

## 4

# Alarm Activation

## 4-1. Gas alarm activation

### <Gas Alarm Type>

"Gas alarm" is triggered when the concentration of detected gas reaches or exceeds the alarm setpoint values shown in the following table. (Self-latching)

Gas alarm types are the first alarm (AL1), second alarm (AL2), TWA alarm, STEL alarm and OVER alarm (over scale).

Alarm type	First alarm	Second alarm	TWA alarm	STEL alarm	OVER alarm
Oxygen (O <sub>2</sub> )	19.5 vol%	23.5 vol%	—	—	40.0 vol%
Combustible gas(HC/CH <sub>4</sub> ) <%LEL>	10 %LEL	50 %LEL	—	—	100 %LEL
Hydrogen sulfide (H <sub>2</sub> S)	5.0 ppm	30.0 ppm	10.0 ppm	15.0 pm	100.0 ppm
Carbon monoxide (CO)	25 ppm	50 ppm	25 ppm	200 ppm	500 ppm
Volatile organic compound (VOC) <10.6eV / ppb>	5000 ppb	10000 ppb	—	—	40000 ppb
Volatile organic compound (VOC) <10.6eV / ppm>	400.0 ppm	1000 ppm	—	—	4000 ppm
Volatile organic compound (VOC) <10.0eV>*	5 ppm	10 ppm	—	—	100 ppm
Sulfur dioxide (SO <sub>2</sub> )	2.00 ppm	5.00 ppm	2.00 ppm	5.00 ppm	99.90 ppm
Nitrogen dioxide (NO <sub>2</sub> )	3.00 ppm	6.00 ppm	3.00 ppm	—	20.00 ppm
Hydrogen cyanide (HCN)	5.0 ppm	10.0 ppm	—	4.7 ppm	15.0 ppm
Ammonia(NH <sub>3</sub> )	25.0 ppm	50.0 ppm	25.0 ppm	35.0 ppm	400.0 ppm
Chlorine(Cl <sub>2</sub> )	0.50 ppm	1.00 ppm	0.50 ppm	1.00 ppm	10.00 ppm
Phosphine(PH <sub>3</sub> )	0.30ppm	1.00ppm	0.30ppm	1.00ppm	20.00ppm
Carbondioxide(CO <sub>2</sub> ) <vol%>	0.50 vol%	3.00 vol%	0.50 vol%	3.00 vol%	10.00 vol%
Carbondioxide(CO <sub>2</sub> ) <ppm>	5000 ppm	—	5000 ppm	—	10000 ppm
Combustible gas(HC) <%LEL/vol%>	10 %LEL/—	50 %LEL/—	—/—	—/—	30.0 vol%
Combustible gas(CH <sub>4</sub> ) <%LEL/vol%>	10 %LEL/—	50 %LEL/—	—/—	—/—	100.0 vol%

\* Alarm point for normal mode. Gas alarm is not triggered in Benzene Select Mode.

**<Sounding Buzzer and Blinking Lamp for Gas Alarm>**

In response to a gas alarm, the buzzer sounds, the alarm LED arrays blink and vibration occurs in two steps.

The following shows the operations of each type.

Alarm type	First alarm	Second alarm	TWA alarm	STEL alarm	OVER alarm
<b>Sounding buzzer</b>	Repeatedly sounds strong and weak beeps at about 1-second intervals. "Beep, beep"	Repeatedly sounds strong and weak beeps at about 0.5-second intervals. "Beep, beep, beep, beep"	Repeatedly sounds strong and weak beeps at about 1-second intervals. "Beep, beep"	Repeatedly sounds strong and weak beeps at about 1-second intervals. "Beep, beep"	Repeatedly sounds strong and weak beeps at about 0.5-second intervals. "Beep, beep, beep, beep"
<b>Blinking alarm LED arrays</b>	Repeatedly blinks at about 1-second intervals.	Repeatedly blinks at about 0.5-second intervals.	Repeatedly blinks at about 1-second intervals.	Repeatedly blinks at about 1-second intervals.	Repeatedly blinks at about 0.5-second intervals.
<b>Vibration</b>	Vibrate at an alarm state.				

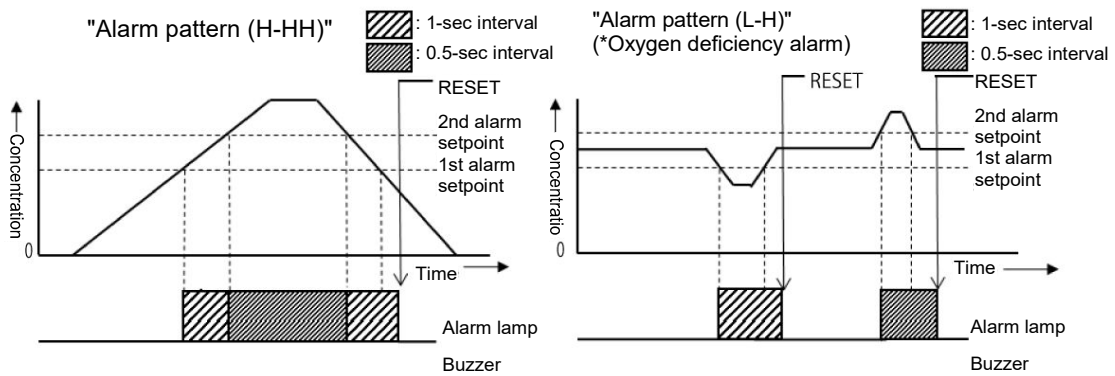

**<Gas Alarm Display>**

In case a gas alarm occurs, the gas concentration and alarm detail are displayed alternately.

If the detection range is exceeded (over scale), [OVER] is displayed in the gas concentration display area.

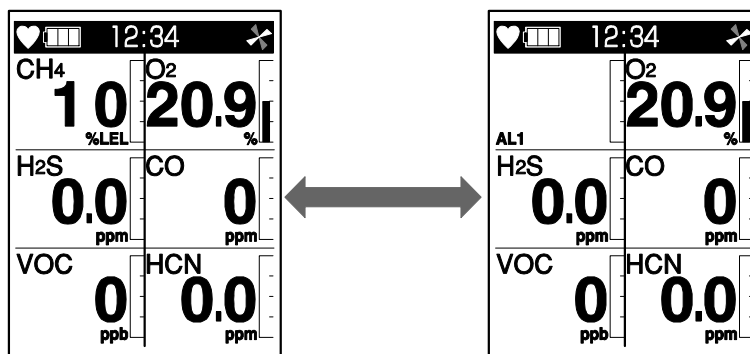

Display example  
Methane (CH<sub>4</sub>) concentration: 10 %LEL  
First alarm triggered

Alarm type	First alarm	Second alarm	TWA alarm	STEL alarm	OVER alarm
LCD display	Displays the gas concentration and [AL1] alternately.	Displays the gas concentration and [AL2] alternately.	Displays the gas concentration and [TWA] alternately.	Displays the gas concentration and [STEL] alternately.	Displays the gas concentration and [OVER] alternately.



**WARNING**

- Issuance of a gas alarm indicates that there are extreme dangers. Take proper actions based on your judgment.

**NOTE**

- Responses to an alarm can be checked by alarm test in the DISP mode (P. 67). Note that the display is not changed during alarm test.

## 4-2. Fault alarm activation

"Fault alarm" is triggered when an abnormality is detected in the gas monitor. (Self-latching)

Fault alarm types are system abnormalities, battery voltage abnormalities, clock abnormalities, low flow rate, sensor abnormalities and calibration failure.

In response to a fault alarm, the buzzer sounds and alarm LED arrays blink.

- Sounding buzzer: Repeatedly sounds intermittent beeps at about one-second intervals. "Beep beep, beep beep"
- Blinking alarm LED arrays: Repeatedly blinks at about one-second intervals.

The following shows display examples of fault alarms.

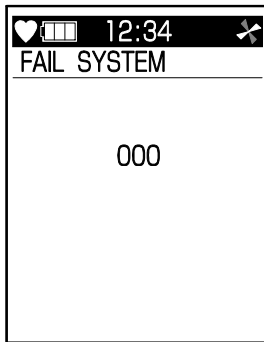

System abnormalities

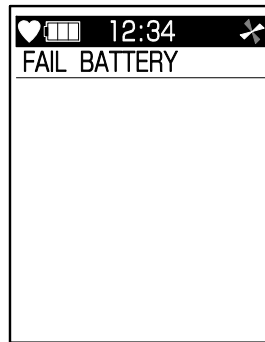

Battery voltage abnormalities

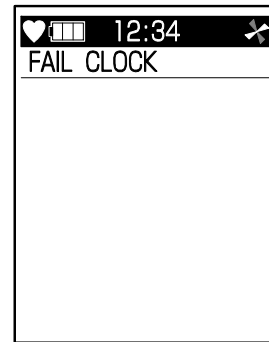

Clock abnormalities

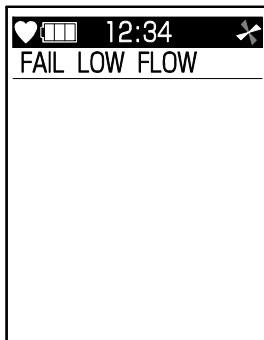

Low flow rate

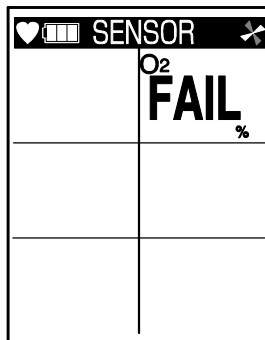

Sensor abnormalities/  
calibration failure

If a fault alarm is triggered, determine the cause and take appropriate action.

If the gas monitor has problems and is repeatedly malfunctioning, contact RIKEN KEIKI immediately.

### NOTE

- For information on malfunctions (error messages), see 'Troubleshooting' (P. 111).

## 4-3. Panic alarm

A panic alarm is a manually triggered alarm to notify the people around of abnormalities.



### WARNING

- The panic alarm is intended to assist users and people around in making a decision. The detection results are not intended to guarantee life or safety in any way. Do not depend only on this function to use the gas monitor.
- Use the panic alarm appropriately after confirming the situation.

### <Sounding Buzzer and Blinking Lamp for Panic Alarm>

Alarm type	Preliminary alarm	Main Alarm
<b>Sounding buzzer</b>	Repeatedly sounds intermittent blips at about 0.5-second intervals. "Blip, blip, blip, blip"	Repeatedly sounds strong and weak beeps at about 1-second intervals. "Beep, beep, beep, beep"
<b>Blinking alarm LED arrays</b>	Repeatedly blinks at about 0.5-second intervals.	Repeatedly blinks at about 1-second intervals.

### Trigger and pattern of panic alarm

Hold down the PANIC button to trigger a panic alarm when sensing an abnormality.

For a panic alarm, a main alarm is triggered after a five-second preliminary alarm.

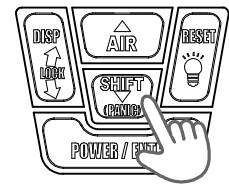

### NOTE

To stop a preliminary or main alarm of panic alarm, press the RESET button.

## 4-4. Man-down alarm

A man-down alarm is triggered if the built-in motion sensor, which monitors the motion of the user carrying the gas monitor, detects no motion of the user for a certain period of time.

Normally the man-down alarm is set to OFF and unavailable. To use this function, please contact RIKEN KEIKI.



### WARNING

- The man-down alarm is intended to assist people around the user in making a decision. The detection results are not intended to guarantee life or safety in any way. Do not depend only on this function to use the gas monitor.
- Use the man-down alarm appropriately after confirming the situation.

### <Sounding Buzzer and Blinking Lamp for Man-down Alarm>

Alarm type	Preliminary alarm 1	Preliminary alarm 2	Main alarm
<b>Sounding buzzer</b>	Repeatedly sounds intermittent blips at about 1-second intervals. "Blip, blip"	Repeatedly sounds intermittent blips at about 0.5-second intervals. "Blip, blip, blip, blip"	Repeatedly sounds strong and weak beeps at about 1-second intervals. "Beep, beep, beep, beep"
<b>Blinking alarm LED arrays</b>	Repeatedly blinks at about 1-second intervals.	Repeatedly blinks at about 0.5-second intervals.	Repeatedly blinks at about 1-second intervals.

### Display and pattern of man-down alarm

If an abnormality in the motion of the user is detected, the lamp blinks and alarms are triggered in a step-by-step manner: preliminary alarm 1, preliminary alarm 2 and then main alarm while vibrating.

When a main alarm is triggered, the clock display on the LCD display shows [MAN DOWN].

The following shows the time to switch from a preliminary alarm to main alarm.

- Preliminary alarm 1: 60 seconds after detection
- Preliminary alarm 2: 75 seconds after detection
- Main alarm: 90 seconds after detection

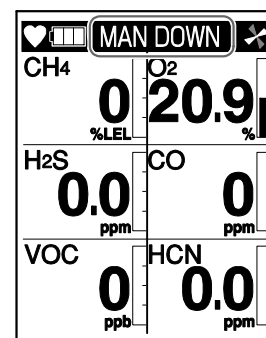

### NOTE

- The preliminary alarms of man-down alarm are stopped and measurement state is resumed when the motion of the user is detected.
- To stop the main alarm of man-down alarm, press the RESET button.

---

## 5

---

# How to Use

### 5-1. Before using the gas monitor

Not only the first-time users but also the users who have already used the gas monitor must follow the operating precautions.

Ignoring the precautions may damage the gas monitor, resulting in inaccurate gas detection.

### 5-2. Preparation for start-up



#### CAUTION

- The display is covered by the protective film to prevent scratches from shipping. Be sure to remove this film before use. Gas monitor with this film will not satisfy the explosion-proof performance.

Before starting gas detection, check the followings.

- Check that the protective film attached on the display from shipping is removed.
- Check that the battery level is sufficient
- Check that the taper nozzle is not bent or has no hole
- Check that the filter inside the gas monitor is not contaminated or clogged
- Check that the main unit and taper nozzle are connected properly

#### 5-2-1. Charging and attaching lithium ion battery unit (BUL-6000)

Charge with the provided charger according to the following procedure when the gas monitor is used for the first time or the battery level of the rechargeable battery in the lithium ion battery unit is low.



#### DANGER

- Replace the lithium ion battery unit in a safe place.
- Charge the battery unit using the provided charger in a safe place.
- Charge the battery unit at ambient temperatures between 0 - +40 °C.
- The specifications of this unit are as follows:  
Maximum voltage: 4.2 V, Ambient temperature: -20 - +50 °C



## CAUTION

- Do not use the gas monitor while charging it. Correct measurements cannot be obtained. Furthermore, the rechargeable batteries get deteriorated more quickly and may have shorter life.
- Do not charge the batteries while the gas monitor is wet. The charger is neither water-proof nor dust-proof.
- The charger is not explosion-proof.
- After attaching the lithium ion battery unit, lock the battery cover completely. If the battery cover is not completely locked, the battery unit may drop off or water may get in through the clearance.
- Do not damage the rubber seal.
- To maintain the water-proof and dust-proof performances, it is recommended to replace the rubber seal every two years, whether or not it has an abnormality.

### <Charging Lithium Ion Battery>

- 1 Insert the DC plug of the AC adapter into the DC jack of the charger.**

Lay the DC plug cord along the side through the notch at the bottom of the charger.

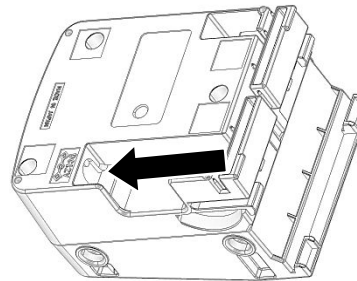

- 2 Insert the AC adapter to the outlet.**

- 3 Insert the main unit to the charger straight from above.**

When the charger is connected, the charging indicator lamp lights up in red. (Full charge requires about three hours at maximum.)

When charging is completed, the charging indicator lamp goes off.

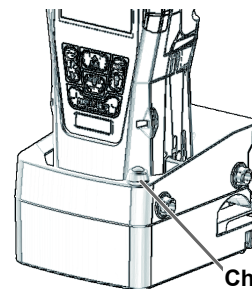

Charging indicator lamp

- 4 When charging is completed, disconnect the AC plug from the outlet.**

### <Removing/Attaching Lithium Ion Battery Unit>

- 1 **Check that the power of the gas monitor is turned off.**  
If the power is on, press the POWER/ENTER button to turn it off.
- 2 **Slide the battery unit release lever to the right side and push it.**

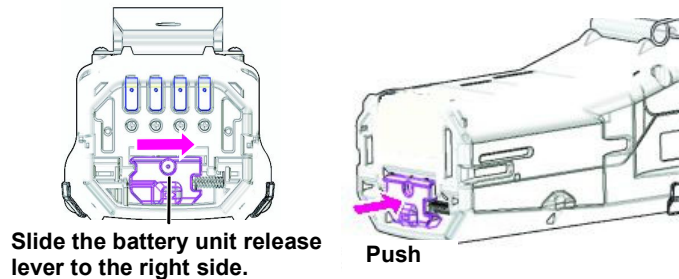

- 3 **Remove the lithium ion battery unit from the main unit.**

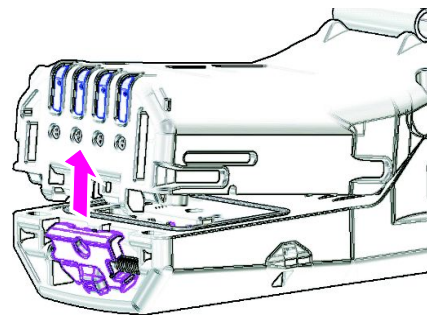

### CAUTION

- Disconnect the AC plug from the outlet while it is not in use.

### NOTE

- When attaching the battery unit, be sure that the battery unit release lever is locked.
- If it is not completely locked, the battery unit may come off or water may get in through the clearance. Water may also get in if a minute foreign substance is caught beneath the battery unit.
- During charging, the lithium ion battery unit may get hot, but this is not an abnormality.
- Charging causes the main unit temperature to increase. When charging is completed, leave it for at least ten minutes before use. If the gas monitor is used while it is still hot, correct measurement may not be performed.
- Fully charged battery cannot be recharged.
- It is possible to charge the lithium ion battery unit alone after removing it from the main unit.

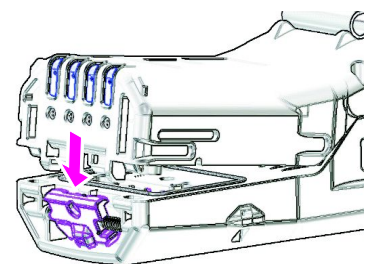

## 5-2-2. Attaching dry battery unit and replacing dry battery(BUD-6000)

When the optional dry battery unit is attached instead of lithium ion battery unit, three AA alkaline batteries are used to operate the gas monitor.

When the dry battery unit is used for the first time, or when the battery level is low, replace or attach new AA alkaline batteries according to the following procedure.



### DANGER

- Replace the dry battery unit in a safe place.
- Replace the batteries in a safe place.
- The specifications of this unit are as follows:  
Maximum voltage: 4.95 V, Power: Alkaline AA batteries, type LR6 manufactured by Toshiba, 1.5 VDC x 3, Ambient temperature: -20 - +50 °C



### CAUTION

- Turn off the power of the gas monitor before replacing the batteries.
- Replace the batteries in a safe place where explosive gases are not present.
- Replace all of the three batteries with new ones at one time.
- Pay attention to the polarities of the batteries when attaching them.
- After attaching the batteries, lock the battery cover completely. If the battery cover is not completely locked, the dry batteries may drop off or water may get in through the clearance. Water may also get in if a minute foreign substance is caught beneath the battery cover.

### <Removing/Attaching Dry Battery Unit>

- 1 Check that the power of the gas monitor is turned off.**  
If the power is on, press the POWER/ENTER button to turn it off.

- 2 Slide the battery unit release lever to the right side and push it.**

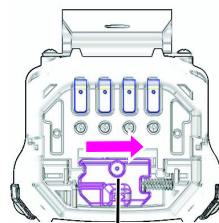

Slide the battery unit release lever to the right side.

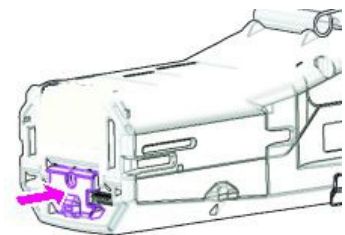

Push

- 3 Remove the dry battery unit from the main unit.**

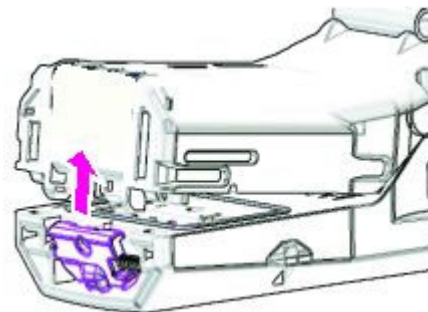



**NOTE**

- When attaching the battery unit, be sure that the battery unit release lever is locked.
- If it is not completely locked, the battery unit may come off or water may get in through the clearance. Water may also get in if a minute foreign substance is caught beneath the battery unit.

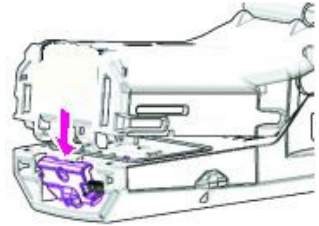
**<Replacing Dry Batteries>**

- 1 Release the lock plate of the battery cover.**

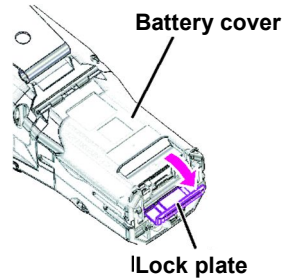

- 2 Open the battery cover.**

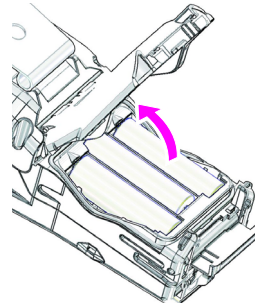

- 3 Put new batteries paying attention to the polarities.**  
Remove old batteries as needed.

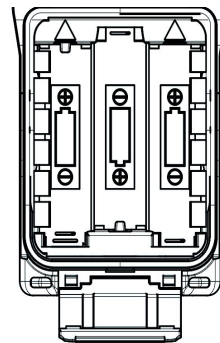

- 4 Close the battery cover and lock plate.**  
Close the lock plate securely until it clicks.

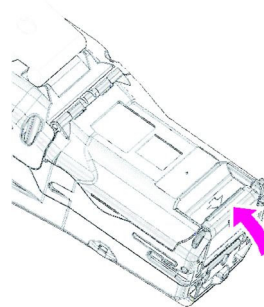

### 5-2-3. Attaching taper nozzle

To perform measurement, attach the taper nozzle to the gas inlet of the gas monitor.

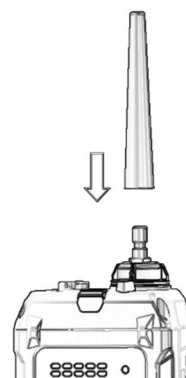

#### DANGER

- Do not use the taper nozzles not specified by RIKEN KEIKI or other parts for the gas monitor.

### 5-2-4. Attaching Pre-Filter Tube(CF-8338) and Tube holder (GF-284) (optional) (only for the specification with VOC<10.0eV> sensor)

GX-6000 with VOC<10.0eV> sensor can measure Benzene concentration in Benzene Select Mode. In Benzene Select Mode, attach Pre-Filter Tube(CF-8338) and Tube holder(GF-284)(optional) according the following procedure.



#### WARNING

- Carefully read the instruction manual of the PID-Pre-Filtre Tube(CF-8338) before use.

#### 1 Break off both ends of Pre-Filter Tube(CF-8338) with the tube-cutter.

Insert the end of the Pre-Filtre Tube to the tube-cutter and totate by 360 degrees to score the tube. Hold the base od the tube and pull it toward you.

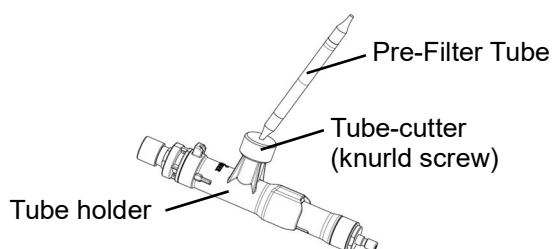

#### 2 Remove the cap of the tube holder pushing the tab of the cap.

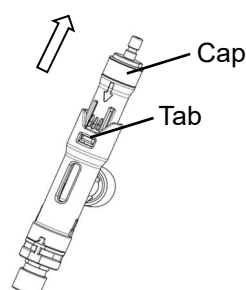

- 3 Insert the tube to the cap of the tube holder.**  
 Insert the tube not to see the shadow area of the tube's label.

**<Correct use>**  
 Shadow area is hidden.

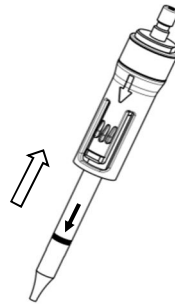

**<Incorrect use>**  
 Shadow area is not hidden.

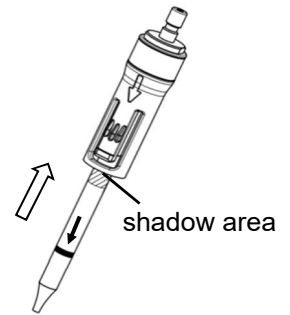

- 4 Connect the cap to the tube holder.**  
 Insert the cap until it clicks.

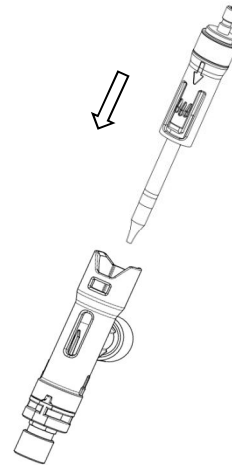

- 5 Connect the tube holder to GX-6000.**  
 Connect the tube to the gas inlet in the following order: the gas inlet, the tube holder and then the taper nozzle.

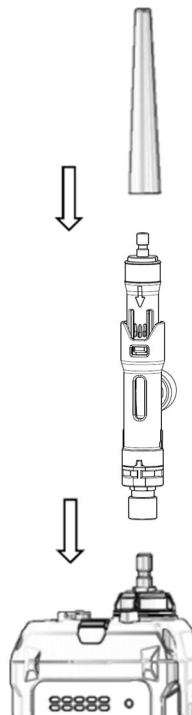



## WARNING

- In the low-temperature environment, the rubber seal is so hard that it is difficult to insert the tube to the tube holder. Prepare in the room-temperature environment and use the gas monitor in as short time as possible.
- Set the CAL code before use the gas monitor in Benzene Select Mode. See 'Set the CAL code of the Pre-Filter Tube' (P.45) for setting the CAL code.

## NOTE

- Connect the gas sampling hose(option) to the gas inlet in the following order: the gas inlet, the gas sampling hose, the tube holder and then the taper nozzle.

## Remove Tube-cutter

Remove the tube-cutter from the tube holder and dispose the tip of the tube cutted with the tube-cutter after use.

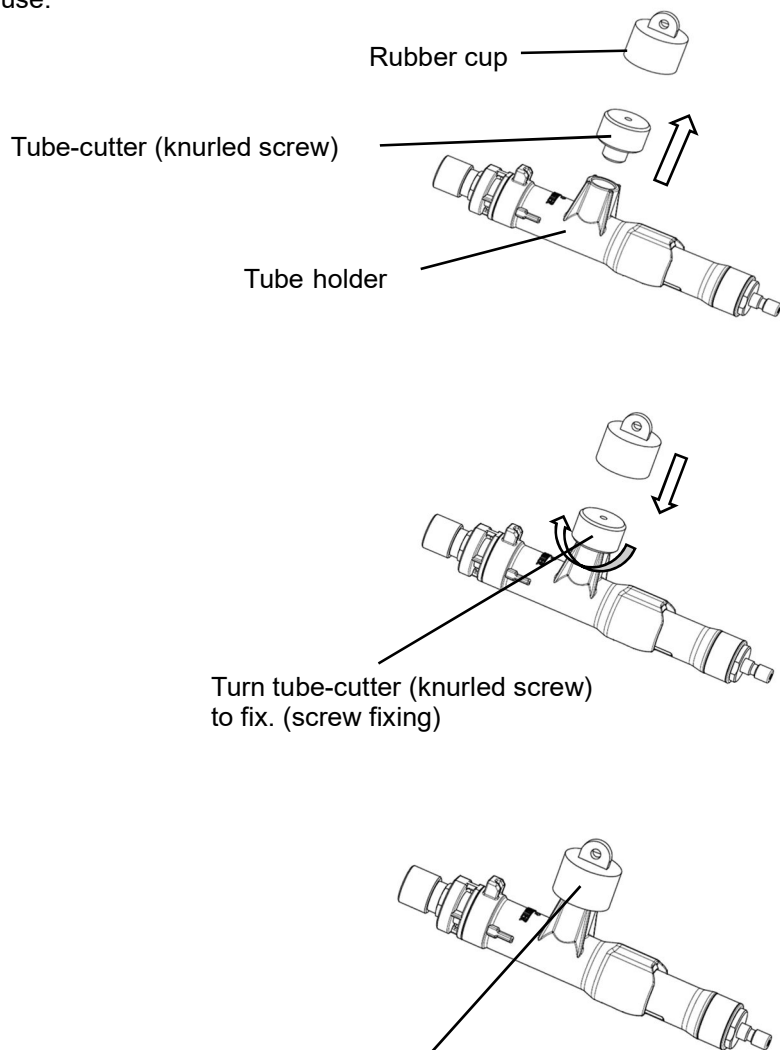

To avoid the possibility of glass fragments inside the rubber cap should be placed firmly over the tube cutter all the way to the back.

## 5-3. How to start the gas monitor

When the power is turned on, various settings including date and alarm setpoint are displayed and then the measurement screen is displayed in the normal mode.

### Power-on

**Hold down the POWER/ENTER button (over five seconds) until the buzzer blips.**  
Power is turned on.

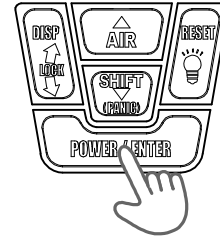

The entire LCD display lights up.



### NOTE

- The gas monitor is equipped with leak check mode as well as normal mode. The leak check mode, however, is set to OFF normally and thus unavailable. To use this function, please contact RIKEN KEIKI.
- When the power is turned on with the leak check mode set to ON, the screen for selecting the normal mode or leak check mode is displayed after the entire LCD display lights up. Select the mode with the ▲/▼ button and press the ENTER button to confirm it.

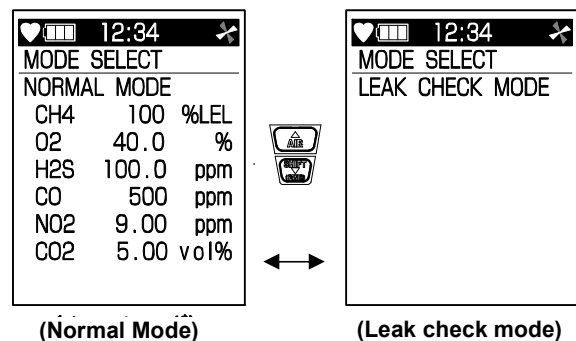

## Screen transition from selecting normal mode to displaying measurement screen

When the power is turned on, the LCD display changes automatically as shown below before the measurement screen is displayed.

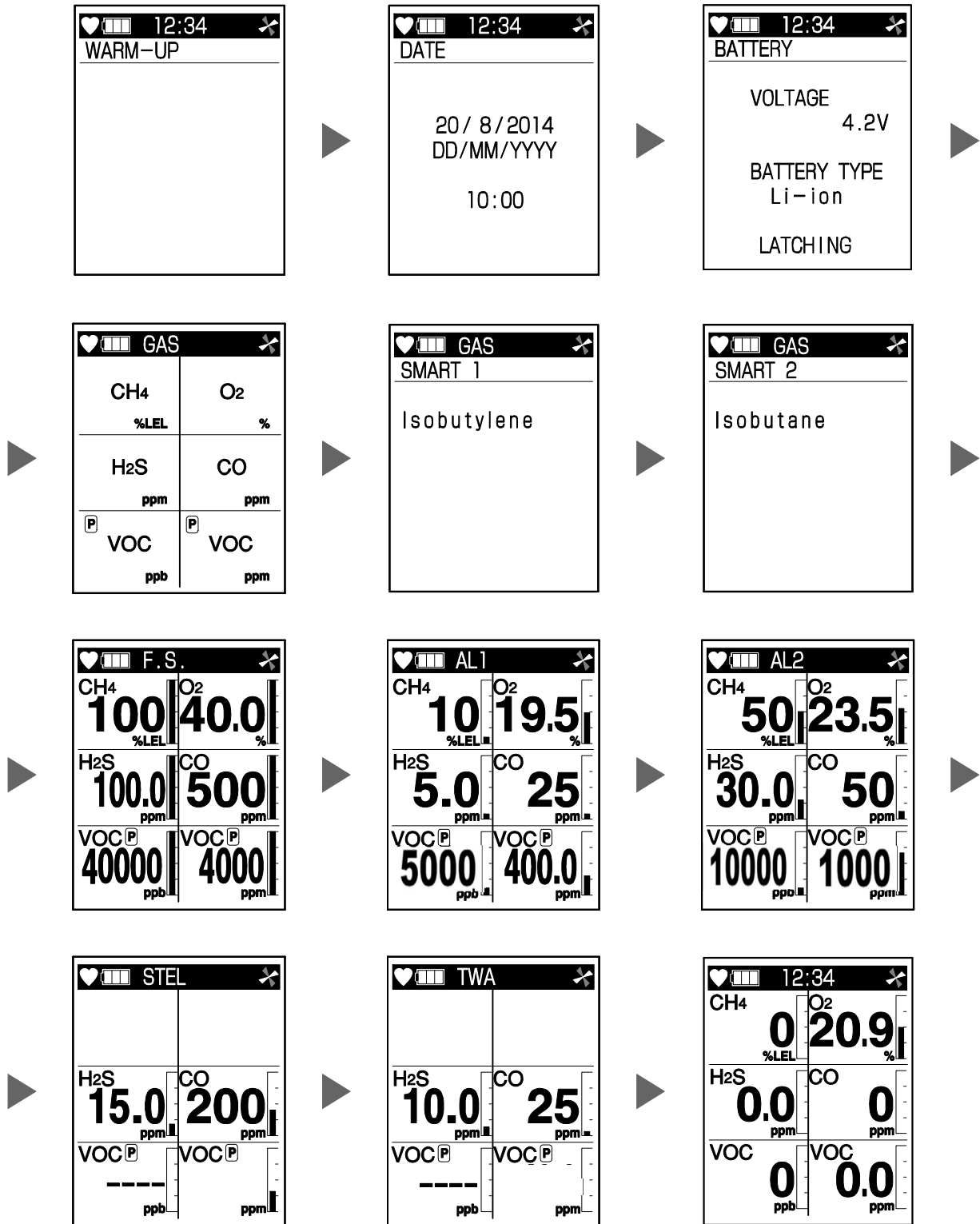

The buzzer blips twice and then the measurement screen is displayed.



## CAUTION

- After start-up, perform air calibration (P. 40) before performing gas detection.

## NOTE

- If any abnormality is detected in the sensor, [FAIL] is displayed in place of measured value just before entering the measurement screen and a sensor abnormality alarm is triggered. In this case, press the RESET button to temporarily reset the sensor abnormality alarm. However, the alarm cannot be reset if there is an abnormality in all the sensors. After the alarm is reset, [- - -] appears in the concentration display area of the gas with sensor abnormality. Detection of the gas having sensor abnormality will become unavailable. Promptly contact RIKEN KEIKI.
- If there is an abnormality in the built-in clock, a fault alarm FAIL CLOCK may be triggered. Press the RESET button in this case. The fault alarm is temporarily reset, and measurement is started with incorrect clock time.

## WARM-UP

Displays the WARM-UP screen.

## DATE

Displays a year/month/day and time. The date/time and display type can be set in the user mode (P. 78).

## BATTERY

- Displays the battery level (voltage) in the upper section of the screen.
- Displays the used battery (lithium ion or dry battery) in the center of the screen.
- Displays the gas alarm pattern setting (LATCHING <self-latching>) in the lower section of the screen.

## GAS

Displays the gas name of detection target. Detection principles are indicated by the following symbols when the smart sensor is installed.

Symbol	Gas to be detected	Detection principle
Ⓢ	Volatile organic compound (VOC)	Photoionization type
Ⓣ	Sulfur dioxide (SO <sub>2</sub> ) Nitrogen dioxide (NO <sub>2</sub> ) Hydrogen cyanide (HCN) Ammonia(NH <sub>3</sub> ) Chlorine(Cl <sub>2</sub> ) Phosphine(PH <sub>3</sub> )	Electrochemical type
Ⓝ	Carbon dioxide (CO <sub>2</sub> ) <vol%> Carbon dioxide (CO <sub>2</sub> ) <ppm> Combustible gas (HC) <%LEL/vol%> Combustible gas (CH <sub>4</sub> ) <%LEL/vol%>	Non-dispersive infrared type

## GAS SMART 1/GAS SMART 2

For the specification targeting volatile organic compound (VOC) for detection, isobutylene or a gas name set for reading is displayed. See 'VOC reading setting' (P. 64) for the reading setting.

## F.S.

Displays the full scale value of the gas to be detected.

## AL1

Displays the first alarm setpoint of the gas to be detected.

## AL2

Displays the second alarm setpoint of the gas to be detected.

## STEL

Displays the STEL alarm setpoint of the gas to be detected. A STEL value refers to a concentration of toxic substances which does not have harmful effects on the users' health by 15-minute continuous exposure provided that everyday exposure does not exceed TWA value.

## TWA

Displays the TWA alarm setpoint of the gas to be detected. A TWA value refers to a time weighted average concentration of toxic substances which is considered no harm on almost all the users' health by repeated exposure at regular work of eight hours a day or 40 hours a week.

## 5-4. Air calibration

Air calibration is zero adjustment to correctly measure the current gas concentration.



### CAUTION

- After start-up, perform air calibration before performing gas detection.

### Attaching the CO<sub>2</sub> removal filter (CF-284) (only for the specification targeting CO<sub>2</sub> for detection)

To perform air calibration for the specification targeting CO<sub>2</sub> for detection, CO<sub>2</sub> in the air needs to be removed using the CO<sub>2</sub> removal filter (CF-284).



### WARNING

- To use the specification targeting VOC and CO<sub>2</sub> for detection, use the CO<sub>2</sub> removal filter and the activated carbon filter to perform air calibration. Connect the filters to the gas inlet in the following order: the gas inlet, the activated carbon filter and then the CO<sub>2</sub> removal filter.

Remove the black tube from the the gray tube and attach the filter so that the arrow (→) on the side is directed at the gas inlet. Stand the CO<sub>2</sub> removal filter to use. With it laid horizontally, CO<sub>2</sub> in the air may not be absorbed.

Direct the arrow at the gas inlet.

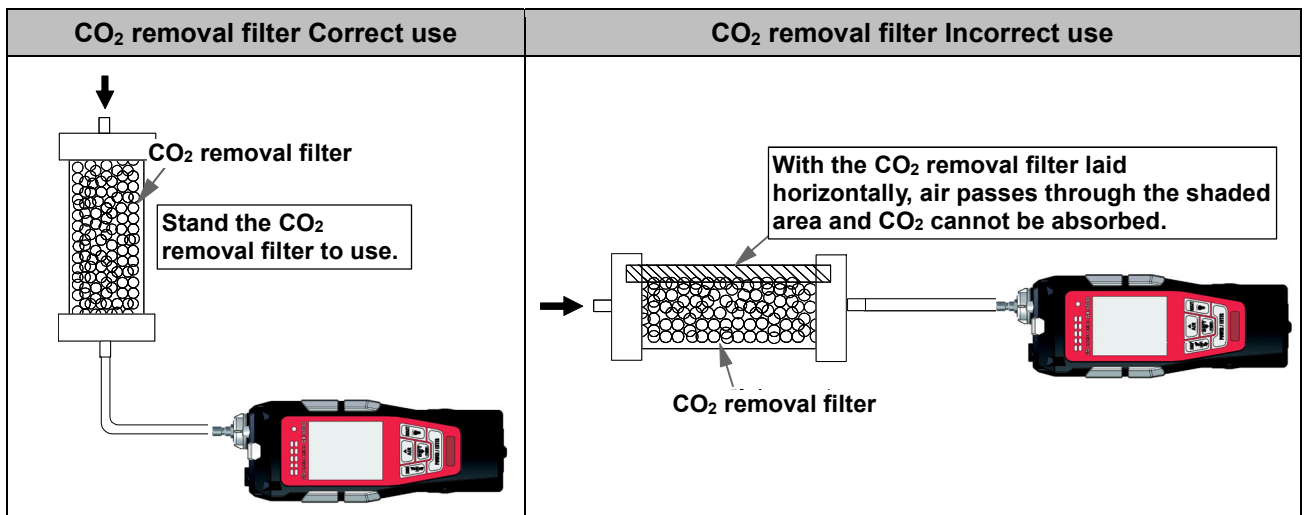



The number of usable times per filter depends on the carbon dioxide concentration in the air. It varies also by the air tightness of CO<sub>2</sub> removal filter, storage temperature or humidity.

The following table shows guide values assuming that each use takes one minute for drawing. However, use the removal filter with a margin when the carbon dioxide concentration in the environment is unknown.

Measurement environment carbon dioxide (CO <sub>2</sub> ) concentration	Estimated number of usable times in consideration of storage condition
500 ppm	Approx. 1000 times
1000 ppm	Approx. 500 times
2000 ppm	Approx. 200 times
4000 ppm	Approx. 100 times



## CAUTION

- Stand the CO<sub>2</sub> removal filter to use. With it laid horizontally, CO<sub>2</sub> in the air may not be absorbed.
- Perform air calibration after sampling fresh air for 1 minute.
- Do not draw high-concentration carbon dioxide during zero calibration.
- Do not breathe on the inlet during zero calibration.
- Block ventilation to the air after using the CO<sub>2</sub> removal filter. With the air mixed, the absorbent absorbs carbon dioxide in the air, resulting in degraded absorption performance.
- Store the CO<sub>2</sub> removal filter in a dry place away from direct sunlight.

## NOTE

- The number of usable times per filter depends on the carbon dioxide concentration in the air. It varies also by the air tightness of CO<sub>2</sub> removal filter, storage temperature or humidity.
- The above table shows guide values assuming that each use takes one minute for drawing. However, use the removal filter with a margin when the carbon dioxide concentration in the environment is unknown.

## Attaching the activated carbon filter (only for the specification targeting VOC for detection)

To perform air calibration for the specification targeting VOC for detection, VOC in the air needs to be removed using the activated carbon filter.

The appropriate carbon filter model varies depending on CO<sub>2</sub> sensor.

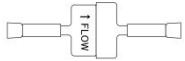
CO <sub>2</sub> sensor	Model of the activated carbon filter	Appearance
Without CO <sub>2</sub> sensor	CF-8350	
With CO <sub>2</sub> sensor	CF-8501	

Remove the caps from the both side of the filter and attach the filter so that the arrow (→) on the side is directed at the gas inlet.

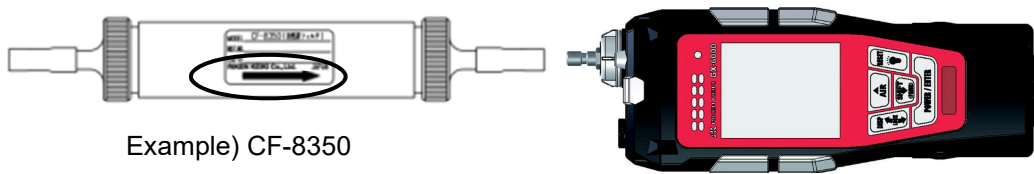

Example) CF-8350

**Direct the arrow at the gas inlet.**



### **WARNING**

- To use the specification targeting VOC and CO<sub>2</sub> for detection, use the CO<sub>2</sub> removal filter and the activated carbon filter to perform air calibration. Connect the filters to the gas inlet in the following order: the gas inlet, the activated carbon filter and then the CO<sub>2</sub> removal filter.



### **CAUTION**

- If an instrument include CO<sub>2</sub> sensor, CO<sub>2</sub> reading may temporarily increase when attaching the activated carbon filter. Perform air calibration after sampling fresh air for 2 minute.
- Attach the caps and block ventilation to the air after using the activated carbon filter.

## Air calibration procedure

- 1 Hold down the AIR button on the measurement screen.**

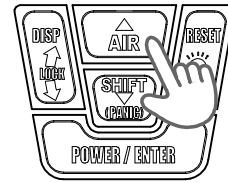

The air calibration screen is displayed.

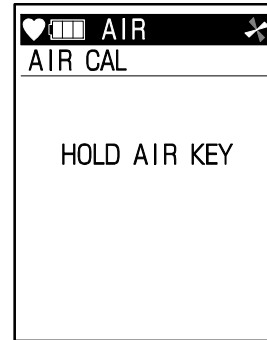

Keep the AIR button pressed while the screen shown in the right figure is displayed. Zero adjustment is not performed when the button is released before the screen is displayed.

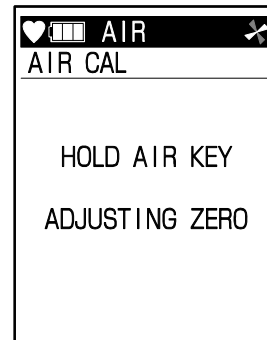

- 2 Release the AIR button when the screen shown in the right figure is displayed.**

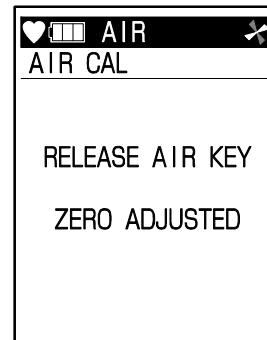

When zero adjustment is completed, the screen shown in the right figure is displayed.

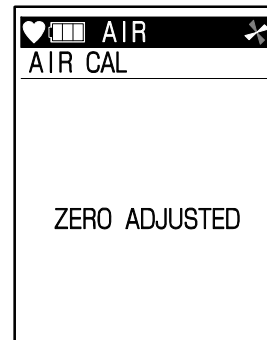

When zero adjustment is successfully completed, the measurement screen returns automatically.

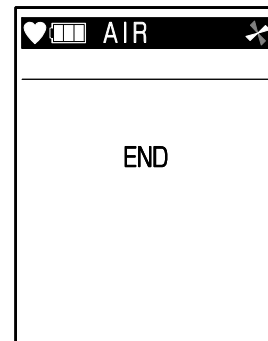

## WARNING

- When air calibration is performed in the atmosphere, check the atmosphere for freshness before beginning it. If interference gases exist, zero adjustment cannot be performed properly, thus leading to dangers when the gas leaks.
- When air calibration is performed in the atmosphere for the specification targeting VOC for detection, use the activated carbon filter (CF-8350 or CF-8501).
- When air calibration is performed in the atmosphere for the specification targeting CO<sub>2</sub> for detection, use the CO<sub>2</sub> removal filter (CF-284).
- When air calibration is performed in the atmosphere for the specification targeting VOC and CO<sub>2</sub> for detection, connect the activated carbon filter and the CO<sub>2</sub> removal filter to the gas inlet in the following order: the gas inlet, the CO<sub>2</sub> removal filter and then the activated carbon filter.
- .



## CAUTION

- Perform air calibration under pressure and temperature/humidity conditions close to those in the operating environment and in fresh air.
- Perform air calibration after the reading is stabilized.
- If there is a sudden temperature change of 15 °C or more between the storage and operational locations turn on the power of the gas monitor, let it stand for about 10 minutes in a similar environment to the operational location, and perform air calibration in fresh air before using it.

## NOTE

- When air calibration fails, [FAIL] appears in the concentration display area of the faulty sensor as well as [SENSOR]. Press the RESET button to reset the fault alarm (calibration failure). When the alarm is reset, the value before calibration is displayed.

## 5-5. Setting the CAL CODE of the Pre-Filter Tube(Only for the specification with VOC<10.0eV>sensor)

Set a CAL code of the Pre-Filter Tube(CF-8338) before use. The CAL code is listed on the shipping box of the Pre-Filter Tube.

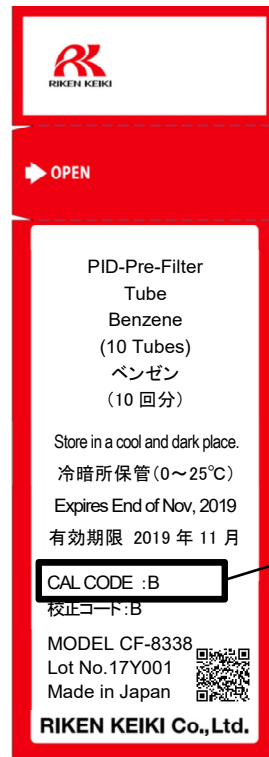

CAL CODE Example:B

- 1 With the measurement screen displayed in the normal mode, press the DISP button and SHIFT buttons at the same time.

The CAL mode screen is displayed.

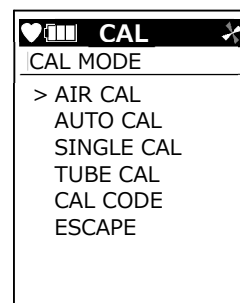

- 2 In the CAL mode, select [CAL CODE] with the ▲/▼ button and then press the ENTER button.

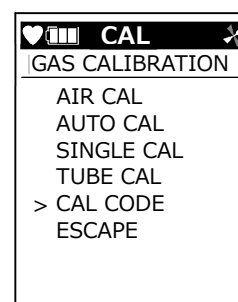

- 3 Select the CAL CODE of the Pre-Filter Tube listed on the shipping box with the ▲/▼ button.

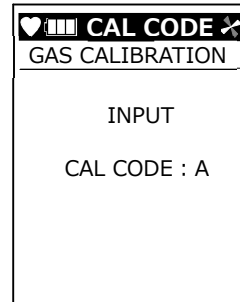

- 4 Press the ENTER button to confirm it. The CAL mode menu returns after setting the CAL CODE.

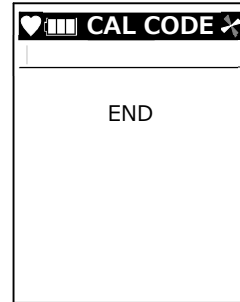

## 5-6. How to detect



### DANGER

- While conducting measurement in a manhole or confined space, do not lean over or look into the manhole or closed space. It may lead to dangers because oxygen-deficient air or other gases may blow out.
- Oxygen-deficient air or other gases may be discharged from the gas exhausting outlet of the gas monitor. Never inhale the air or gases.
- High-concentration (100 %LEL or higher) gases may be discharged from the gas exhausting outlet of the gas monitor. Never use fire near it.



### WARNING

- The gas monitor is designed to draw gases around it under the atmospheric pressure. If excessive pressure is applied to the gas inlet and outlet of the gas monitor, detected gases may leak out from its inside and may cause dangerous conditions. Be sure that excessive pressure is not applied to them while used.
- Do not connect the taper nozzle directly to a detection area with a pressure higher than the atmospheric pressure. The internal piping system may be damaged.
- When air calibration is performed in the atmosphere, check the atmosphere for freshness before beginning it. If interference gases exist, the calibration cannot be performed properly, thus leading to dangers when the gas leaks.
- Issuance of a gas alarm indicates that there are extreme dangers. Take proper actions based on your judgment.
- Gas detection cannot be performed with a low battery voltage. If the low battery voltage alarm is triggered during use, turn off the power and promptly charge or replace the batteries in a safe place.
- Do not block the buzzer sound opening. No alarm sound can be heard.

## 5-6-1. Basic operating procedures

### <Normal Mode>

This mode is used on the measurement screen after power-on.

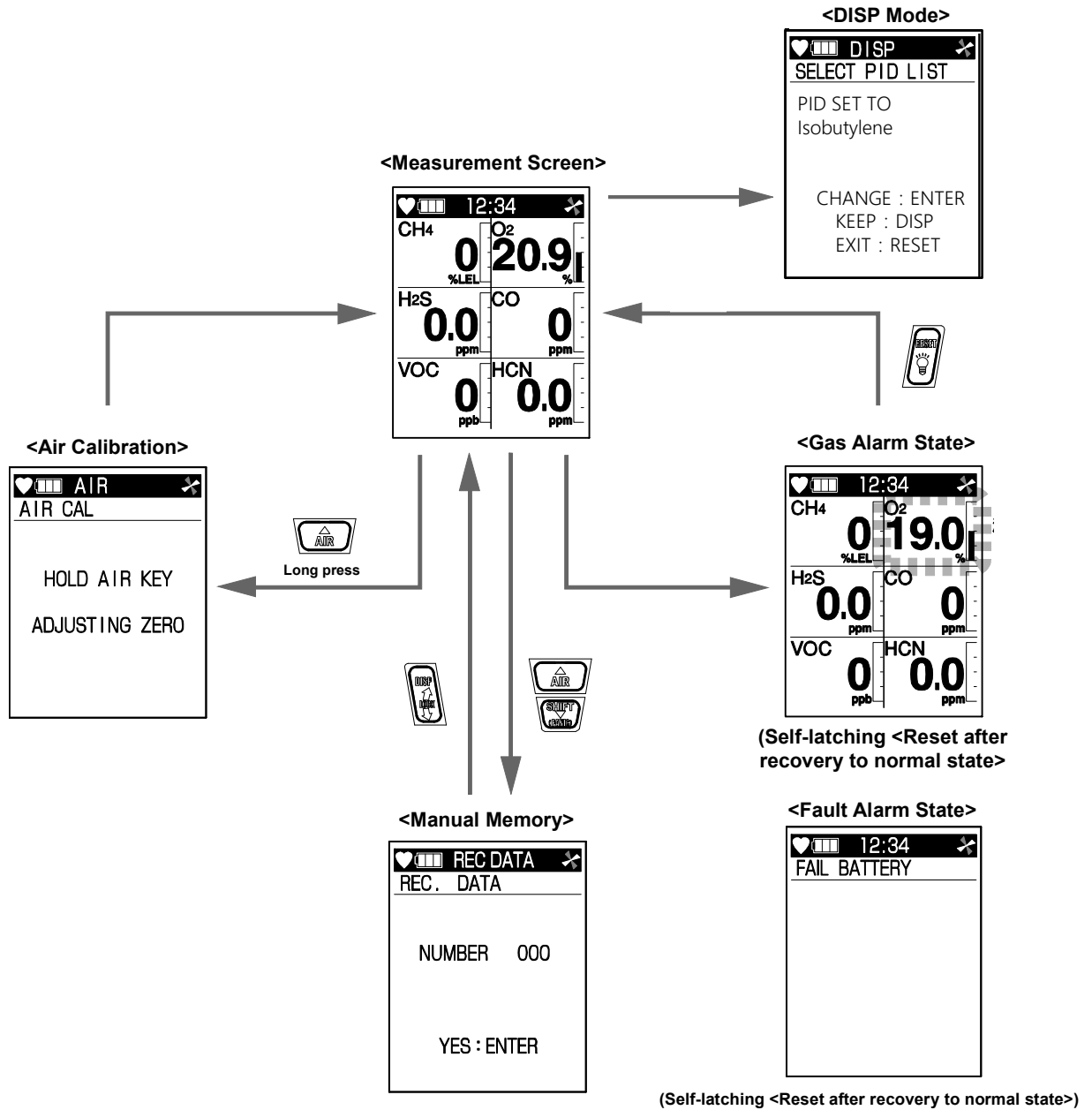

### NOTE

- Only GX-6000 with the VOC<10.0eV> sensor can enter the Benzene Select mode through the DISP mode.



<Leak Check Mode>

The gas monitor is equipped with leak check mode as well as normal mode. The leak check mode, however, is set to OFF normally and thus unavailable. To use this function, please contact RIKEN KEIKI.

With the leak check mode set to ON, the mode selection screen is displayed after power-on. When the leak check mode is selected, the following screen transition is made.

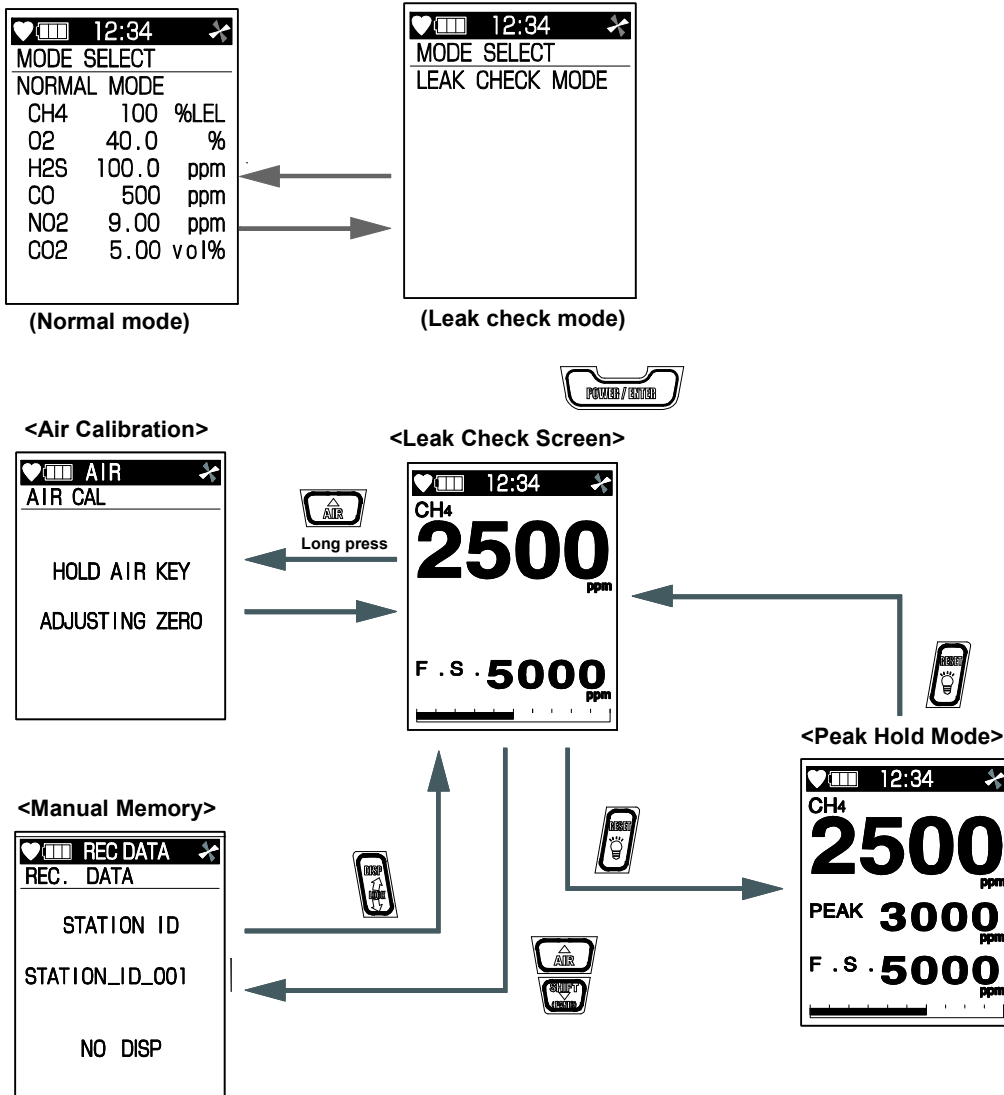

NOTE

- In the leak check mode, a full scale value can be selected from four levels: 500 ppm, 1000 ppm, 2000 ppm and 5000 ppm. The value switches to another every time the DISP button is pressed.
- The buzzer sounds intermittently according to the gas concentration. As the concentration becomes higher, the interval of beeps of the buzzer becomes shorter.
- For the specification targeting carbon monoxide (CO) for detection, the PEAK value and carbon monoxide (CO) concentration can be set so that they are displayed alternately every time the RESET button is pressed. Contact RIKEN KEIKI for the setting.

## 5-6-2. Normal Mode / Leak Check Mode

With the measurement screen displayed, put the taper nozzle close to the detection area and read the value on the LCD display.

### <Normal Mode>

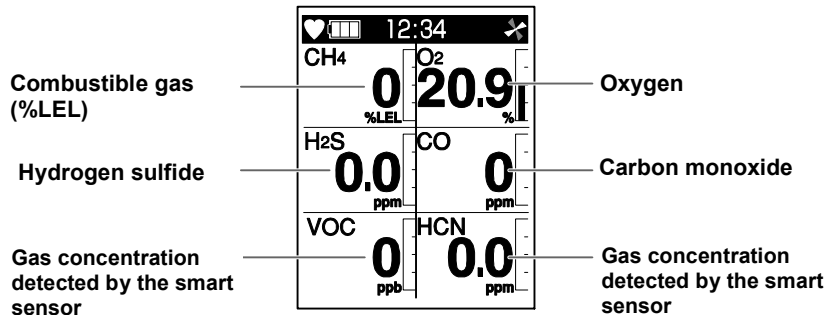

Display example

### <Leak Check Mode>

The gas monitor is equipped with leak check mode as well as normal mode for the combustible gas using the new ceramic sensor. The leak check mode, however, is set to OFF normally and thus unavailable. To use this function, please contact RIKEN KEIKI.

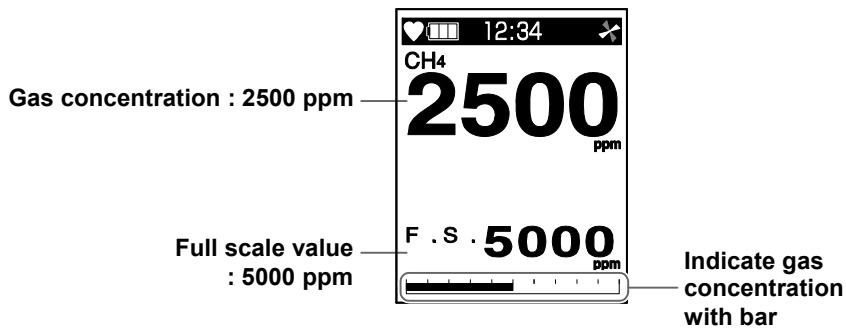



## CAUTION

- When measuring concentrations of oxygen in inert gases for a long time, the carbon dioxide concentration in the air must be 15 % or less. When the gas monitor is used in the inert gas with a carbon dioxide concentration higher than 15 %, perform measurement in as short time as possible. Using the gas monitor under high concentrations for a long time may shorten the life of the oxygen sensor.
- Some sensors will respond to a gas other than their target gas. The table below indicates some of the gases that will cause an increased reading for the affected sensor. For example, if you are attempting to detect HCN and H<sub>2</sub>S is also present, the instrument's HCN reading will be higher than the environment's actual HCN level.

Examples of interference gases that cause increased readings

Principle of sensor used in GX-6000 (Target gas)	/	Interference gas
Electrochemical(HCN)	/	H <sub>2</sub> S
Electrochemical(HCN)	/	SO <sub>2</sub>
Electrochemical(HCN)	/	C <sub>2</sub> H <sub>2</sub>
Electrochemical(SO <sub>2</sub> )	/	H <sub>2</sub>
Electrochemical(SO <sub>2</sub> )	/	CO
Electrochemical(CO)	/	H <sub>2</sub>
Electrochemical(Cl <sub>2</sub> )	/	SO <sub>2</sub>
Electrochemical(Cl <sub>2</sub> )	/	HCl
Electrochemical(PH <sub>3</sub> )	/	SO <sub>2</sub>
Electrochemical(PH <sub>3</sub> )	/	HCN
Electrochemical(PH <sub>3</sub> )	/	H <sub>2</sub> S
New ceramic (HC/CH <sub>4</sub> )	/	Combustible gases
Non-dispersive infrared type(HC/CH <sub>4</sub> )	/	Hydrocarbon gases of combustible gases
PID (VOC)	/	VOC

- Some toxic sensors will respond negatively to some gases that may be present along with the target gas. The table below indicates some of the gases that will cause a negative response and a decreased reading for the affected sensor.

Examples of interference gases that cause decreased readings

Principle of sensor used in GX-6000 (Target gas)	/	Interference gas
Electrochemical(H <sub>2</sub> S)	/	NO <sub>2</sub>
Electrochemical(HCN)	/	NO <sub>2</sub>
Electrochemical(NO <sub>2</sub> )	/	SO <sub>2</sub>
Electrochemical(SO <sub>2</sub> )	/	NO <sub>2</sub>
Electrochemical(NH <sub>3</sub> )	/	H <sub>2</sub> S
Electrochemical(PH <sub>3</sub> )	/	NO <sub>2</sub>

- Exposing the new ceramic combustible sensor to silicone, halogen gases, or sulfides may shorten the sensor's life or cause malfunctions or inaccurate gas readings. Minimize the sensor's exposure to these gases as much as possible. If exposure occurs, allow the instrument to draw fresh air and confirm that the readings return to fresh air values.
- Exposing the galvanic oxygen sensor to halogen gas or sulfides may shorten the sensor's life or cause malfunctions or inaccurate gas readings. Minimize the sensor's exposure to these gases as much as possible. If exposure occurs, allow the instrument to draw fresh air and confirm that the readings return to fresh air values.
- An oxygen concentration higher than a certain level is required for the new ceramic combustible gas sensor <%LEL> of the gas monitor to correctly detect gases and display concentrations.
- When measuring concentrations of oxygen in inert gases for a long time, the carbon dioxide concentration in the air must be 15 % or less. When the gas monitor is used in the inert gas with a carbon dioxide concentration higher than 15 %, perform measurement in as short time as possible. Using the gas monitor under high concentrations for a long time may shorten the life of the oxygen sensor.



## CAUTION

- The CO reading on GX-6000 may increase after being exposed to high concentration of VOC gases. If the reading is not returned to zero, the charcoal filter for CO sensor is required. Contact RIKEN KEIKI for the filter replacement.
- Long-time detection of a high-concentration combustible gas may adversely influence the combustible gas sensor <%LEL>. If presence of high-concentration combustible gas in a measurement location is known in advance, set the combustible gas sensor <%LEL> protection setting (P. 73) to ON before use.
- The gas sampling hose may absorb a small amount of several of the GX-6000's target gases, such as toxic gases, solvents, or VOCs. This absorption causes the target gas reading on the GX-6000 to be lower than the sampled environment's actual gas level.
- If gases that are easily absorbed by the gas sampling hose are encountered, be sure to allow the instrument to draw fresh air through the gas sampling hose until the affected reading returns to a fresh air value.
- When the gas sampling hose is not being used, its outgassing characteristics may result in a small buildup of gas to which the VOC sensor will respond. If a sampling hose has been sitting unused for a period of time, when that gas sampling hose is connected to a GX-6000, the VOC channel may temporarily show a reading. The reading will return to a fresh air reading after all of the built up gas has been drawn out of the gas sampling hose.
- Be careful when measuring concentrations of Cl<sub>2</sub> and NH<sub>3</sub> at a lower limit of operating temperature (around -20 °C), the response time to the gas may slow down due to the gas characteristic.
- When high concentrations of methane gas, ethane gas, propane gas, etc. are present, the PID type VOC sensor may display "----" in the concentration display section, the lamp may blink, the buzzer may sound, and measurement may become temporarily impossible.  
Note that in an environment where these gases are present, even if "----" is not displayed on the concentration display, the VOC concentration may not be measured correctly. Note that even if "----" is displayed in the concentration display section of the VOC sensor, sensors that are not affected by anything other than the VOC sensor can continue to measure.

Example of interfering gas where "----" is displayed in the concentration display section of a PID type VOC sensor

Interference gas	Gas concentration
Methane	≥ 6vol%
Ethane	≥ 80vol%
Propane	≥ 90vol%

### 5-6-3. Benzene Select Mode (only for the specification with the VOC<10.0eV> sensor)

With the measurement screen displayed in Benzene Select mode, put the taper nozzle close to the detection area and read the value on the LCD display.

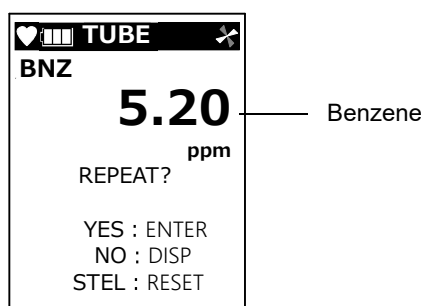



## CAUTION

- Measurement time is determined by temperature automatically. Read the value after the measurement time. See 'Change to the Benzene Select Mode' (P.59).
- Only VOC<10.0eV> sensor is active in Benzene Select Mode and no gas alarm is triggered.

## NOTE

- In a low-temperature environment, the operating time is shortened due to the battery performance property.
- At low temperatures, the responses of the LCD display may slow down.
- If a combustible gas with 100 %LEL or higher concentration is drawn, some adsorbed gas may remain in the taper nozzle or filter. After drawing a high-concentration combustible gas, be sure to draw in fresh air and perform the air clening until the reading indicates zero to remove adsorbed gases. Performing fresh air calibration before cleaning completely may result in inaccurate adjustment, giving adverse influence on measurement.
- The display automatically switches to the vol% range when the concentration of a combustible gas exceeds 100 %LEL, which detected by Non-dispersive infrared type sensor. When the concentration drops, the display returns to the %LEL range again. The following shows an example of switching timing.

Diagram example of gas concentrations and range switching timing

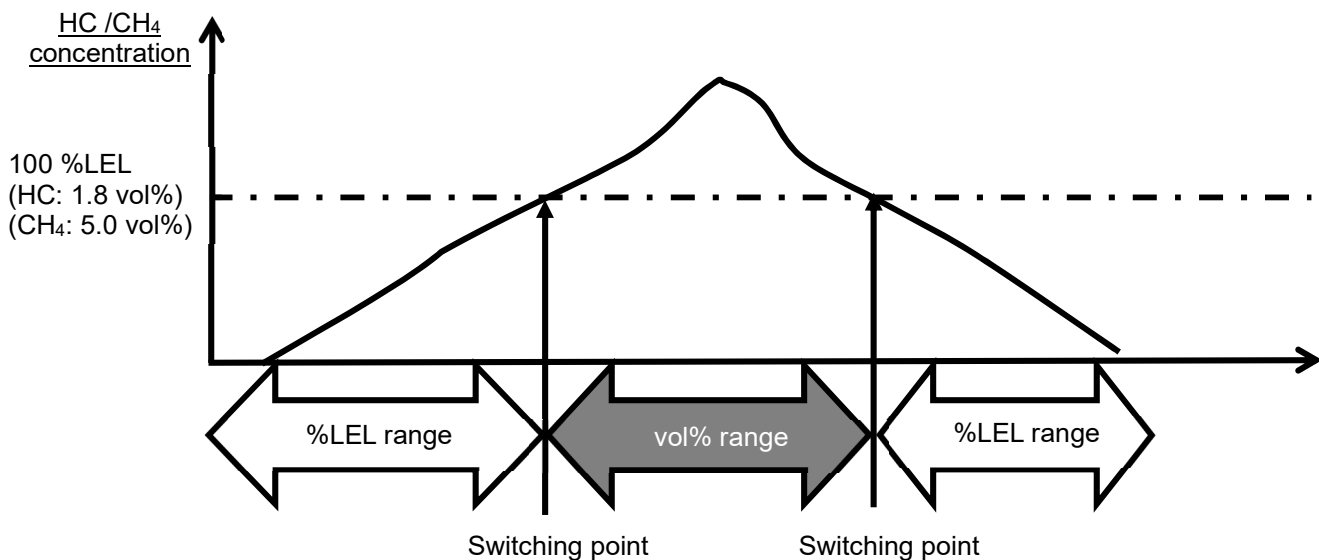

\* HC: Isobutane converted.

CH<sub>4</sub>: Methane

The range switching point is a lower explosive limit of a gas. It is 1.8 vol% for isobutane and 5.0 vol% for methane.

## 5-6-4. Manual memory

Up to 256 arbitrary instantaneous values during measurement can be recorded. When the number of recorded data points reaches the maximum, recorded data will be overwritten, starting from the oldest data.

**1 Hold down the ▲ and ▼ buttons at the same time on the measurement screen.**

The memory number, station ID, recorded date and recorded concentration are displayed in turn as shown below.

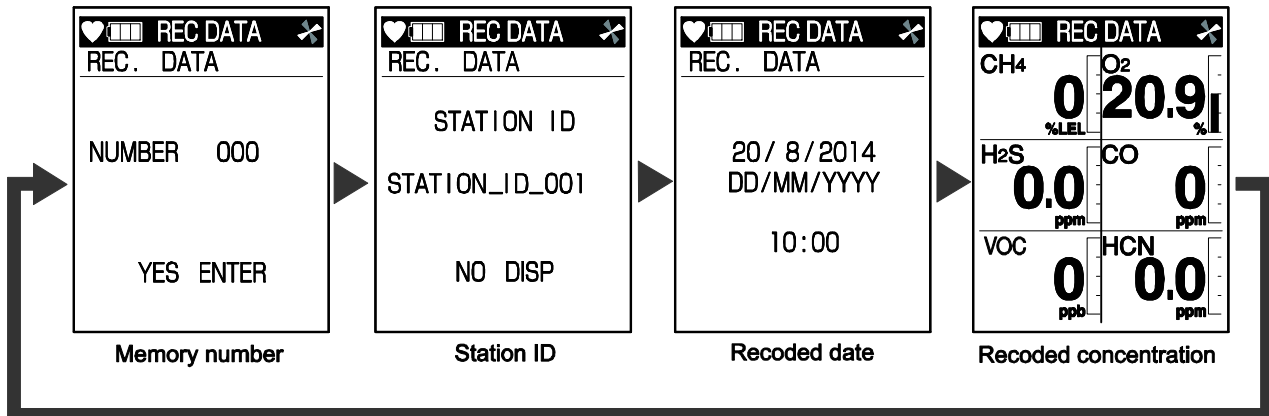
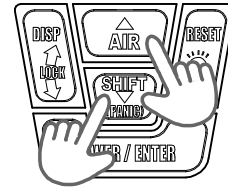

**2 Press the ENTER button.**

[SAVED] is displayed on the screen, and the memory number, station ID, date and gas concentration at the time the ENTER button is pressed are recorded.

After recording, the data from memory number to recorded concentration are displayed again in turn. To continue recording the data, press the ENTER button.

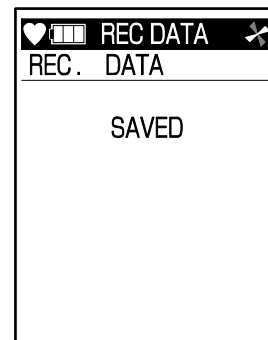

**3 Press the DISP button to end.**

The measurement screen returns.

### NOTE

- The gas concentration data recorded by manual memory can be viewed according to 'Log data display' (P. 71).

## 5-7. Power-off



### CAUTION

- If the concentration display is not reset to zero (or 20.9 % for the oxygen concentration display) after measurement is completed, leave the gas monitor in fresh air until the display returns to zero and then turn off the power.

### Keep the POWER/ENTER button pressed.

To turn off the power, hold down the POWER/ENTER button after the display returns to zero (0, or 20.9 % for oxygen) in a safe place.

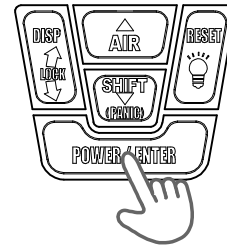

The buzzer blips three times and [TURN OFF] appears on the display before the power is turned off.

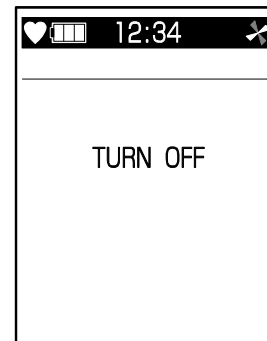

Power-off

### NOTE

- To turn off the power, keep the button pressed until the display disappears.



### CAUTION

- When the gas monitor is contaminated, clean it with a waste cloth, etc.
- When cleaning the gas monitor, do not use organic solvents such as alcohol and benzene on it.

## 6

# Setting Procedure

## 6-1. Display setting (DISP mode) flow

The DISP mode allows users to view and change various display settings.

### Press the DISP button on the measurement screen in normal mode.

Various screens are displayed in turn by pressing the DISP button.

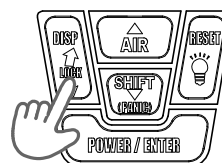

### Press the DISP button when settings are completed.

The previous screen returns. Press the button several times more to call the measurement screen.

### Press the RESET button to return to the the measurement screen.



Press the RESET button in each screen to return to the the measurement screen.

Item	Details	LCD display	Remarks
<b>Change to Benzene Select Mode</b>  (Displayed only for the specification with VOC<10.0eV> sensor)	Changes to Benzene Select Mode from Normal Mode. In Benzene Select Mode, measure Benzene with the Pre-Filter Tube (CF-8338).		Press the ENTER button to go to the setting screen (P. 61)
<b>VOC reading setting</b>  (Displayed only for the specification with VOC<10.0eV>sensor)	By changing the setting to the pre-registered gas in the gas monitor, the converted concentration from the detection target gas (isobutylene) of VOC <10.0eV> sensor will be displayed.		Press the ENTER button to go to the setting screen (P.64)

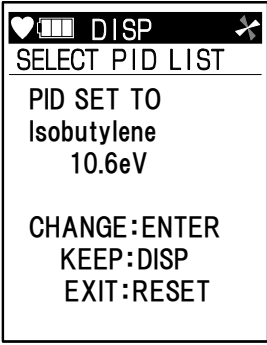
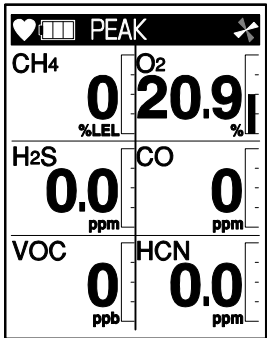
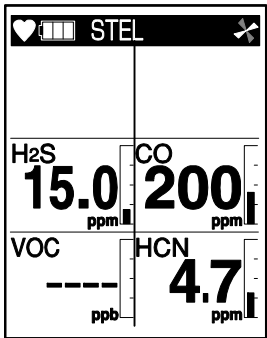
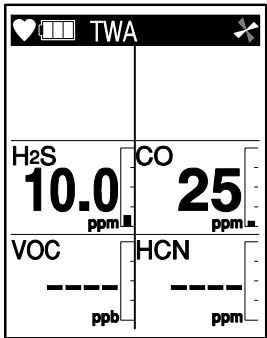
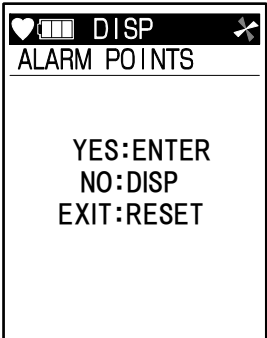

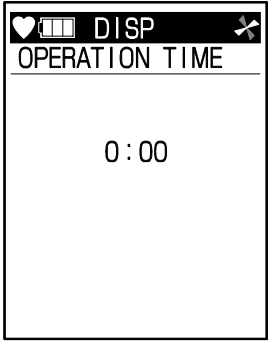
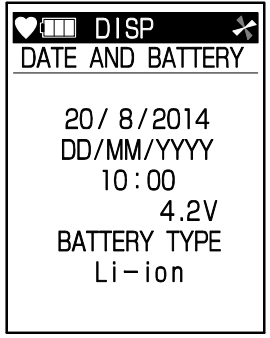
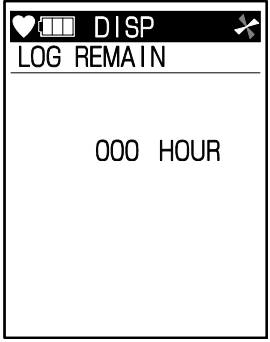
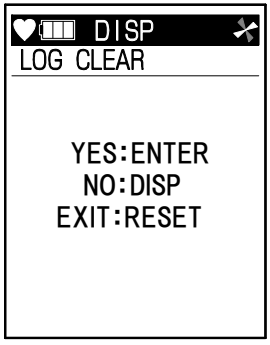
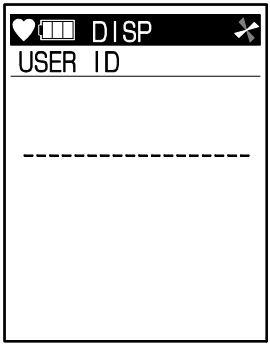
<p><b>VOC reading setting</b>  (Displayed only for the specification with VOC &lt;10.6eV/ppb&gt; sensor and VOC &lt;10.6eV/ppm&gt;sensor)</p>	<p>By changing the setting to the pre-registered gas in the gas monitor, the converted concentration from the detection target gas (isobutylene) of VOC &lt;10.6eV/ppb &gt; sensor and VOC &lt;10.6eV/ppm&gt; sensor will be displayed.</p>		<p>Press the ENTER button to go to the setting screen (P.64)</p>
<p><b>PEAK display/clear</b></p>	<p>Displays the maximum concentration of gas (or minimum concentration for oxygen) detected from power-on to the present.</p>		<p>Go to the PEAK display/clear screen (P. 66)</p>
<p><b>STEL value display</b></p>	<p>Displays the STEL value after power-on.</p>		
<p><b>TWA value display</b></p>	<p>Displays the TWA value after power-on.</p>		
<p><b>Full scale/ alarm setpoint display/ alarm test</b></p>	<p>Displays the full scale and alarm setpoint values and allows users to check the alarm activation of the setting displayed.</p>		<p>Press the ENTER button to go to the confirmation screen (P. 67)</p>

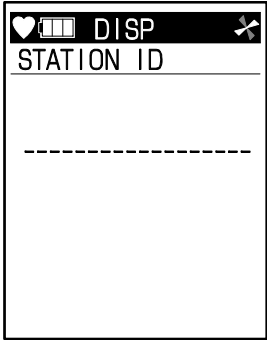
<p><b>Measurement time display</b></p>	<p>Displays the measurement time from power-on.</p>		
<p><b>Date/voltage display</b></p>	<p>Displays a date and time, battery level and battery type.</p>		
<p><b>Data logger remaining time display</b></p>	<p>Displays the remaining time which data logger can record.</p>		
<p><b>Clear log data</b></p>	<p>Clears the data recorded in the manual memory.</p>		<p>Press the ENTER button to go to the clear screen (P. 68)</p>
<p><b>User ID display/selection</b></p>	<p>Displays user ID and allows users to select it.</p>		<p>Press the ENTER button to go to the display/selection screen (P. 69)</p>

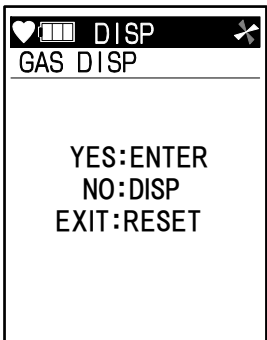
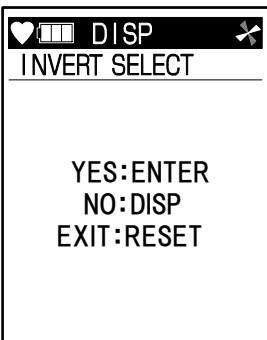
<b>Station ID display/selection</b>	Displays station ID and allows users to select it.		Press the ENTER button to go to the display/selection screen (P. 70)
<b>Log data display</b>	Displays data recorded in the manual memory.		Press the ENTER button to go to the display screen (P. 71)
<b>Peak display setting</b>	Used to set peak display so that a peak value blinks on the bar displayed on the right side of gas concentration on the measurement screen.		Press the ENTER button to go to the setting screen (P. 72)
<b>Gas concentration display setting</b>	Used to set the measurement screen to split display to six divisions or single display. When the single display is selected, automatic or manual switching of display can be set.		Press the ENTER button to go to the setting screen (P. 73)
<b>LCD inversion setting</b>	Used to invert the LCD display by 180 degrees according to the direction of the gas monitor.		Press the ENTER button to go to the setting screen (P. 74)

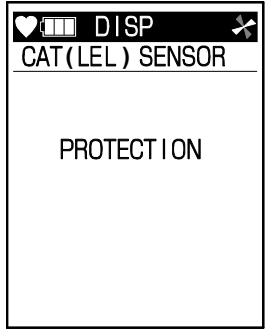
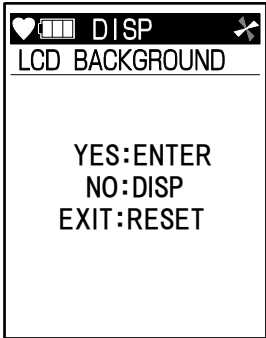
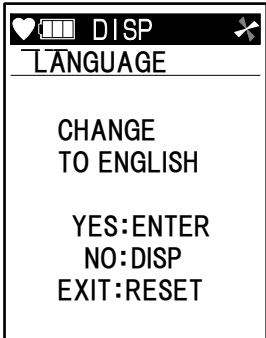
<p><b>Combustible gas sensor &lt;%LEL&gt; protection setting</b></p> <p>(Displayed only for the specification targeting combustible gas &lt;%LEL&gt; for detection)</p>	<p>Protects the combustible gas sensor &lt;%LEL&gt; from high-concentration combustible gases.</p>		<p>Press the ENTER button to go to the setting screen (P. 75)</p>
<p><b>LCD black and white inversion setting</b></p>	<p>Used to invert the black and white display of LCD.</p>		<p>Press the ENTER button to go to the setting screen (P. 76)</p>
<p><b>English display setting</b></p> <p>(Displayed only when selecting languages other than English)</p>	<p>Used to resume English display when another language is set.</p>		<p>Press the ENTER button to go to the setting screen (P. 77)</p>

**NOTE**

- If the screen is left unoperated for 20 seconds, the measurement screen returns.
- Press the RESET button in each screen to return to the the measurement screen.
- Pressing the DISP button on the English display setting screen returns to the measurement screen.

## 6-2. Display setting

### Change to Benzene Select Mode

(only for the specification with VOC<10.0eV> sensor)

This item is used to change to Benzene Select Mode from Normal Mode. In Benzene Select Mode, measure Benzene with the Pre-Filter Tube and Tube holder (optional). See 'Attaching Pre-Filter Tube (CF-8338) and Tube holder (GF-284)(optional)' (P.34).

- 1 Press the DISP button to display the screen shown in the right figure, and then press the ENTER button.

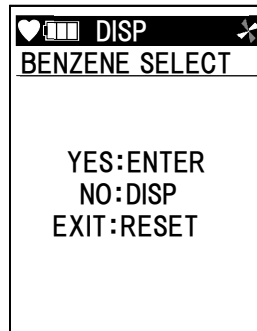

- 2 Attach the Pre-Filter Tube (CF-8338) and Tube holder (GF-284) (optional), and then press the ENTER button. Pump and Data logger stop.

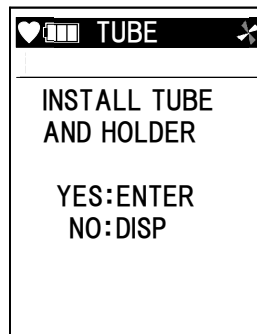

- 3 Press the ENTER button. Press the ENTER button to start measurement. Press the DISP button to return to the Normal Mode. [REMOVE HOLDER] display is shown, and then press the ENTER button.

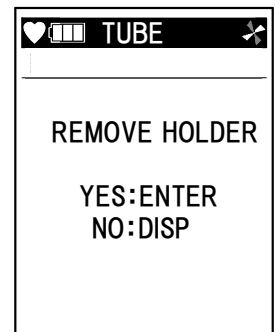
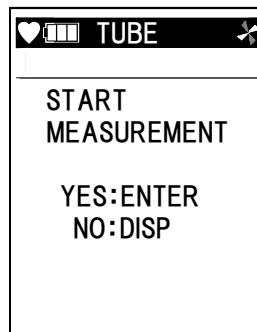

Pump starts, and then measurement starts. Countdown is shown in the display. Measurement time varies depending on temperature. See the following list about the measurement time. The number in the list is shown in the bottom left corner of the display.

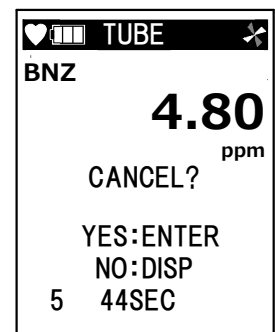
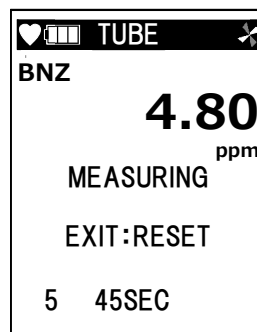

- |    |       |   |          |              |
|----|-------|---|----------|--------------|
| 1. | -20.0 | - | -10.1 °C | :135 seconds |
| 2. | -10.0 | - | -0.1 °C  | :110 seconds |
| 3. | 0.0   | - | +9.9 °C  | : 90 seconds |

- 4. +10.0 - +19.9 °C : 70 seconds
- 5. +20.0 - +29.9 °C : 45 seconds
- 6. +30.0 - +50.0 °C : 35 seconds



After the countdown, the result of measurement is displayed.

- To restart measurement:  
Press the ENTER button.  
Change the Pre-Filter Tube and press the ENTER button.  
⇒ Step 3 "START MEASUREMENT" display
- To return to measurement mode in Normal mode:  
Press the DISP button.  
⇒ Step 3 "REMOVE HOLDER" display
- To start STEL measurement:  
Press the RESET button.  
⇒ Step 4 "STAERT STEL MEASUREMENT"

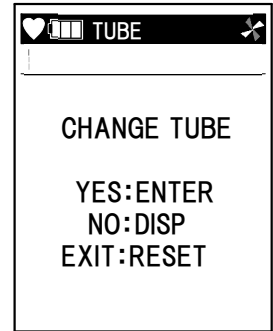

**4 Press the ENTER button.**

STEL measurement starts.

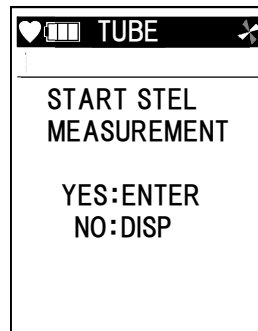

900-second measurement time is shown in the display and countdown starts.

To stop the procedure, press the RESET button and press the ENTER button.

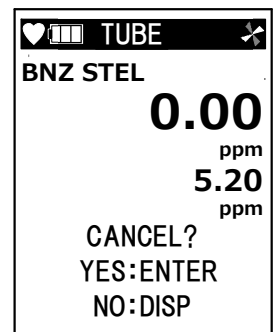

The result is displayed.

- To restart STEL measurement:  
Press the ENTER button.  
⇒ Step 3 [CHANGE TUBE] display
- To return to measurement mode in Normal mode:  
Press the DISP button  
⇒ Step 3 [REMOVE HOLDER] display



## VOC reading setting (only for the specification targeting VOC for detection)

Normally, a volatile organic compound (VOC) concentration is displayed after isobutylene conversion; however, the reading can be converted to a pre-registered gas concentration.

- 1 Press the DISP button to display the screen shown in the right figure, and then press the ENTER button.**

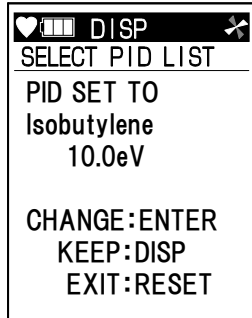

For VOC<10.0eV>sensor

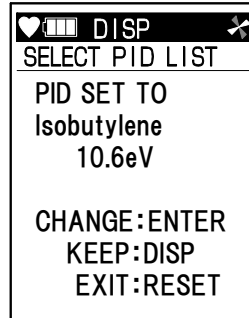

For VOC<10.6eV>sensor

- 2 Select with the ▲/▼ button.**

USER LIST indicates a set gas list, and RECENT indicates a recently selected gas list. All gases are displayed from A to X.

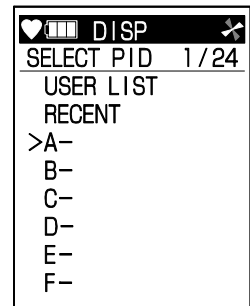
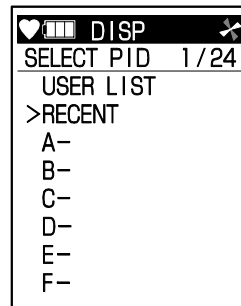
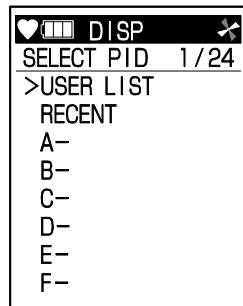

- 3 Press the ENTER button.**

Gas types are displayed.

Press the DISP button to return to the step 2.

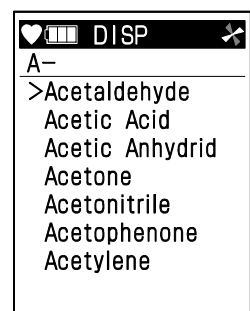
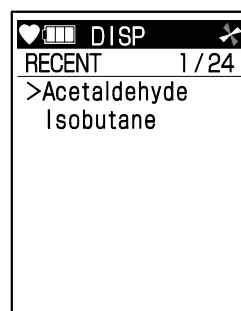
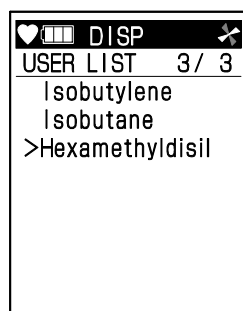

- 4 Press the ENTER button.**

The name, chemical formula, conversion factor, etc. of each gas are displayed.

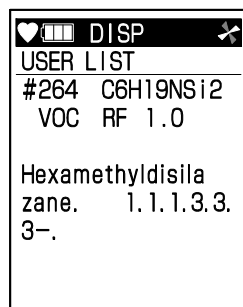



Press the DISP button to return to the step 3.

**5 Press the ENTER button.**

When the setting is completed, the screen shown in the step 1 returns automatically.

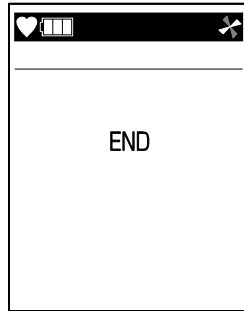

**NOTE**

- When the specification with both VOC<10.0eV>sensor and VOC<10.6eV>sensor in one unit, it show 10.0eV first and 10.6eV later. Set for each sensor.
- The setting is retained after power-off.
- Up to 30 frequently selected gas types can be registered in USER LIST.
- The setting program for the list of gases for reading VOC (optional) is required to use USER LIST.
- The history of selecting gas type from the list of all gases can be kept in RECENT (up to eight types).
- See the appendix 'List of gases for reading VOC' (P. 121) for the gas types available for reading.

## PEAK display/clear

This item is used to display or clear the maximum concentration (or minimum concentration for oxygen) detected during measurement from power-on to the present.

- 1 Press the DISP button to display the screen shown in the right figure.

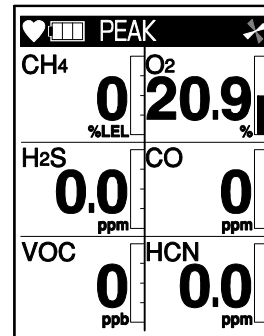

- 2 Hold down the RESET button to clear PEAK value.

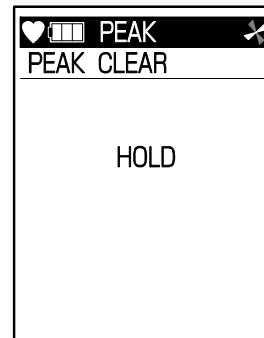

- 3 When [RELEASE] is displayed, release the RESET button.

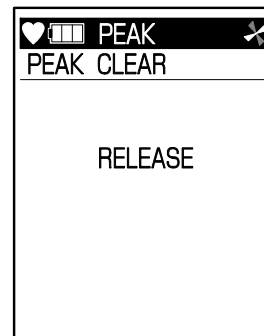

PEAK value has been cleared.  
After PEAK value is cleared, the screen shown in the step 1 returns automatically.

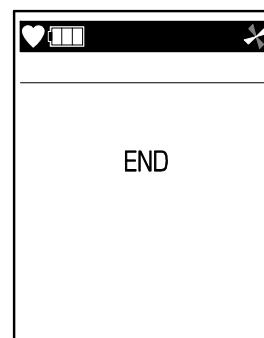

## Full scale/alarm setpoint display/alarm test

This item is used to display the full scale and alarm setpoint values and check the alarm activation of the setting displayed.

Note that the LCD display is not changed during alarm test.

- Press the DISP button to display the screen shown in the right figure, and then press the ENTER button.**

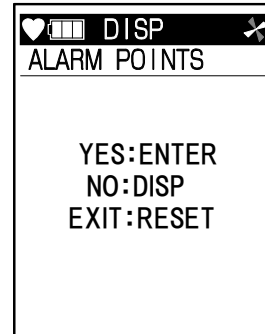

- Press the ▲/▼ button to display the full scale or alarm setpoint values.**

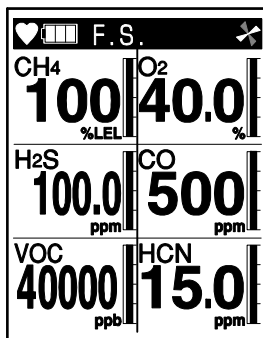

Full scale display

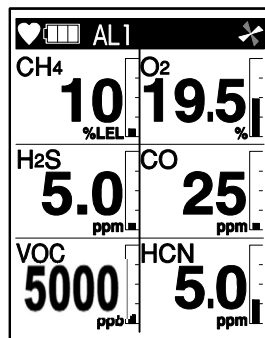

Alarm 1 display

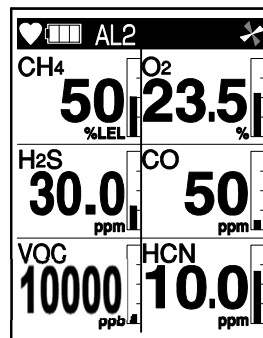

Alarm 2 display

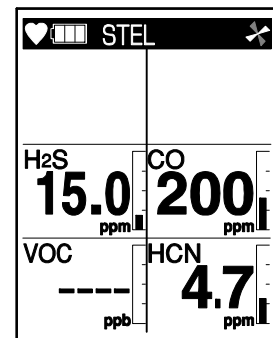

STEL Value Display

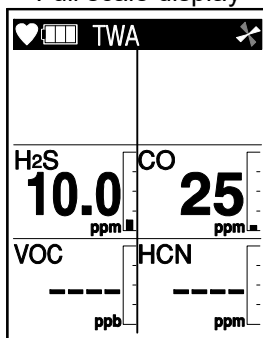

TWA Value Display

- Display a desired screen and press the ENTER button.**

The alarm LED arrays blink in red, allowing the user to check the alarm activation of the screen displayed.

- Press the ENTER button to stop the alarm activation.**

To exit from the display and alarm test, press the DISP button to return to the screen shown in the step 1.

## Clear log data

This item is used to clear the log data recorded in the manual memory.

- 1 **Press the DISP button to display the screen shown in the right figure, and then press the ENTER button.**

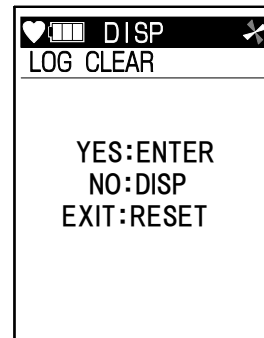

- 2 **Press the ENTER button to clear the log data.**

Press the DISP button to return to the screen shown in the step 1 without clearing the log data.

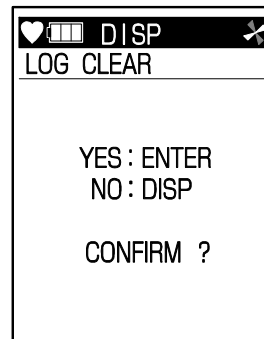

- 3 **Press the ENTER button.**

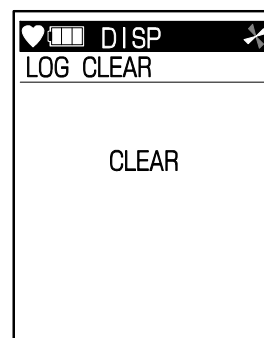

The log data has been cleared.  
After the log data is cleared, the screen shown in the step 1 returns automatically.

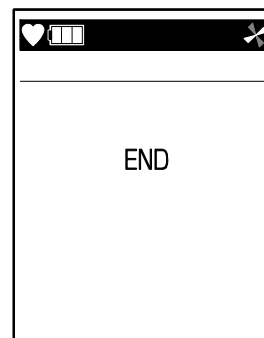

### NOTE

- When saved data clear is executed, all the data recorded up to that time will be deleted.

## User ID display/selection

This item is used to display or select user ID.

- 1 **Press the DISP button to display the screen shown in the right figure, and then press the ENTER button.**

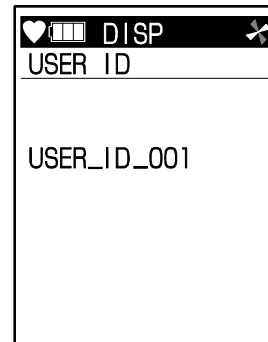

- 2 **Select user ID with the ▲/▼ button.**  
Press the DISP button to return to the screen shown in the step 1 without displaying or selecting user ID.

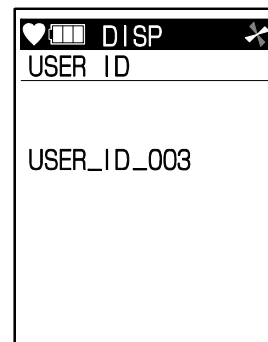

- 3 **Press the ENTER button.**  
When the selection is completed, the screen shown in the step 1 returns automatically.

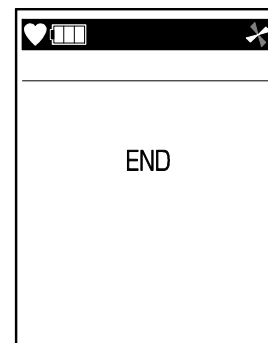

### NOTE

- When the unit is used for the first time, user ID is displayed as shown in the right figure.
- If not specified, user ID numbers are registered as 001 - 128.
- The data logger management program (optional) is required to register or change an ID. Contact RIKEN KEIKI to purchase it.

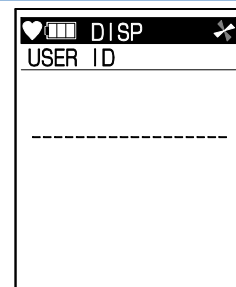

## Station ID display/selection

This item is used to display or select station ID.

- 1 **Press the DISP button to display the screen shown in the right figure, and then press the ENTER button.**

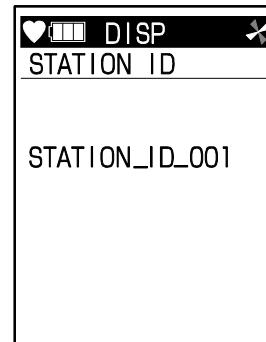

- 2 **Select station ID with the ▲/▼ button.**  
Press the DISP button to return to the screen shown in the step 1 without displaying or selecting station ID.

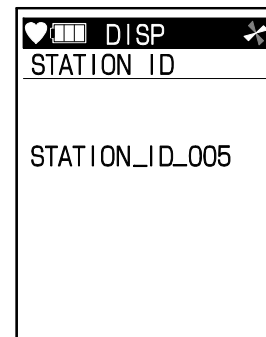

- 3 **Press the ENTER button.**  
When the selection is completed, the screen shown in the step 1 returns automatically.

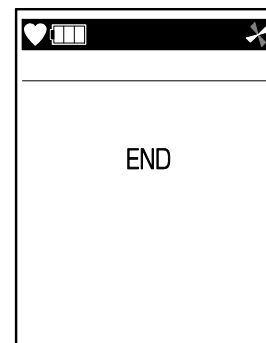

### NOTE

- When the unit is used for the first time, station ID is displayed as shown in the right figure.
- If not specified, station ID numbers are registered as 001 - 128.
- The data logger management program (optional) is required to register or change an ID. Contact RIKEN KEIKI to purchase it.

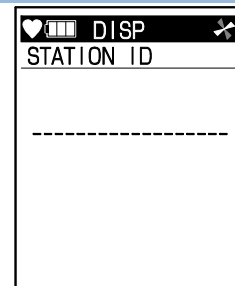

## Log data display

This item is used to display log data recorded in the manual memory.

- 1 **Press the DISP button to display the screen shown in the right figure, and then press the ENTER button.**

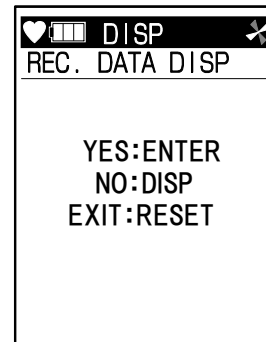

- 2 **Select recorded data with the ▲/▼ button.**

Recorded data is indicated by year/month/day, time and memory number. When a station ID has been set, it is displayed under a memory number. Press the DISP button to return to the screen shown in the step 1 without displaying the log data.

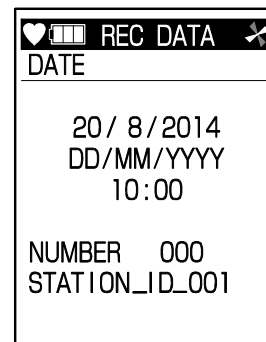

- 3 **Press the ENTER button.**

The selected recorded data is displayed. Press the ENTER button again to return to the screen shown in the step 2. To exit from the log data display, press the DISP button to return to the screen shown in the step 1.

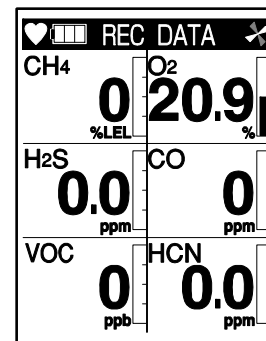

### NOTE

- See 'Manual memory' (P.54) for recording gas concentrations.
- When no gas concentration is recorded, the screen shown in the right figure appears.

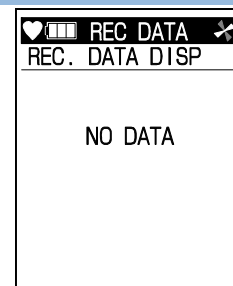

## Peak display setting

This item is used to set peak display so that a peak value blinks on the bar displayed on the right side of gas concentration on the measurement screen.

- 1 **Press the DISP button to display the screen shown in the right figure, and then press the ENTER button.**

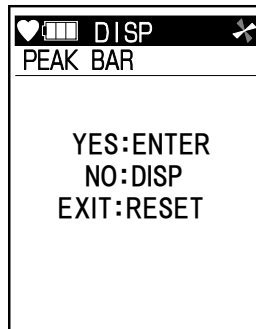

- 2 **Select with the ▲/▼ button.**  
 Select whether or not to blink peak value on the bar.  
 Press the DISP button to return to the screen shown in the step 1 without changing the setting.

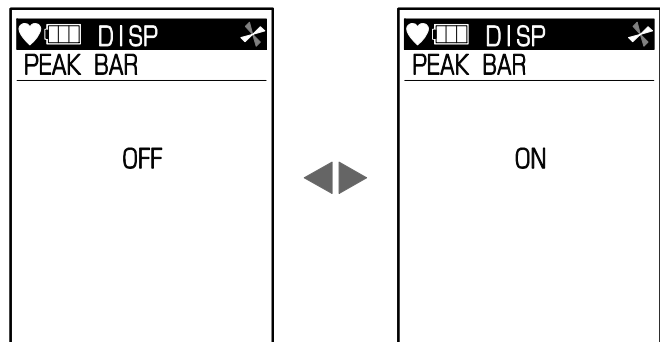

- 3 **Press the ENTER button.**  
 When the setting is completed, the screen shown in the step 1 returns automatically.

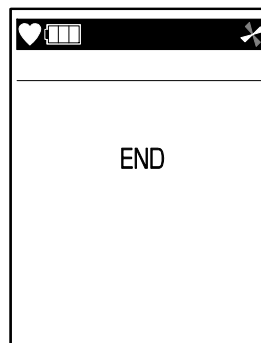

### NOTE

- When the peak bar display setting is selected, peak value blinks on the bar as shown in the right figure.

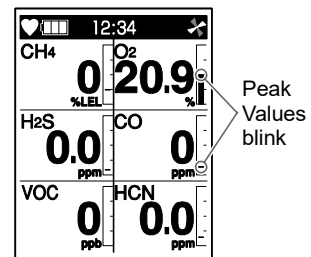



## Gas concentration display setting

This item is used to select the measurement screen display type from split display to six divisions and single display. For the single display, automatic or manual switching of display can be selected.

- 1 **Press the DISP button to display the screen shown in the right figure, and then press the ENTER button.**

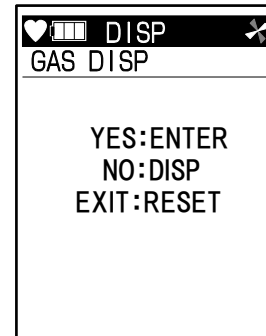

- 2 **Select display type with the ▲/▼ button.**

[DISPLAY ALL] indicates a split display to six divisions.

[SCROLL AUTO] indicates a single display which displays multiple channels in turn automatically.

[SCROLL MANUAL] indicates a single display which switches a gas concentration display to another manually by pressing the ENTER button. Press the DISP button to return to the screen shown in the step 1 without changing the setting.

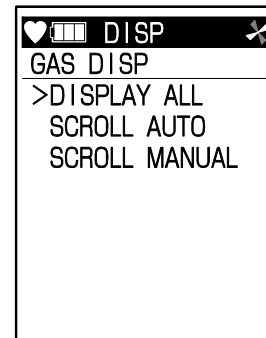

- 3 **Press the ENTER button.**

When the setting is completed, the screen shown in the step 1 returns automatically.

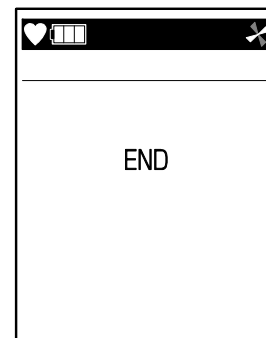

### NOTE

- The figures on the right show examples of split display to six divisions and single display.
- The gas concentration display setting is reset by turning on/off the power.

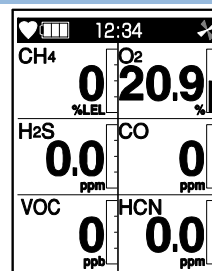

## LCD inversion setting

This item is used to invert the LCD display by 180 degrees according to the direction of the gas monitor.

- 1 **Press the DISP button to display the screen shown in the right figure, and then press the ENTER button.**

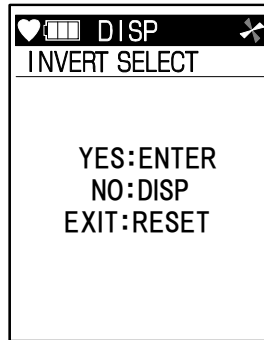

- 2 **Select with the ▲/▼ button.**  
 Select the LCD inversion setting.  
 Press the DISP button to return to the screen shown in the step 1 without changing the setting.

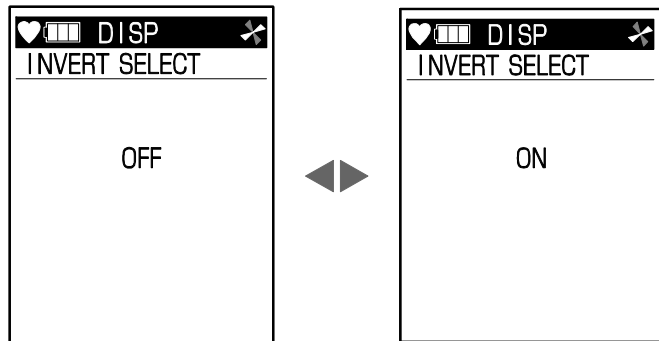

- 3 **Press the ENTER button.**  
 When the setting is completed, the screen shown in the step 1 returns automatically.

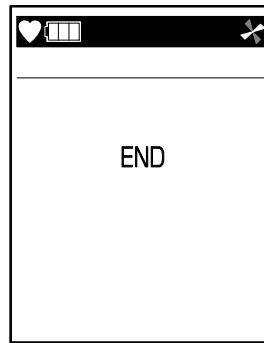

### NOTE

- When the LCD inversion setting is set to OFF (display direction fixed), [LOCK] is displayed (lights up steadily) in the upper right section of the screen as shown in the right figure.
- Even when the LCD inversion setting is set to ON (display direction inverted), the display direction can be fixed by holding down the DISP button during use. While the display direction is fixed, [LOCK] is displayed (blinks) in the upper right section of the screen as shown in the right figure.
- For the case the display direction is fixed by holding down the DISP button, the setting is reset by turning on/off the power.

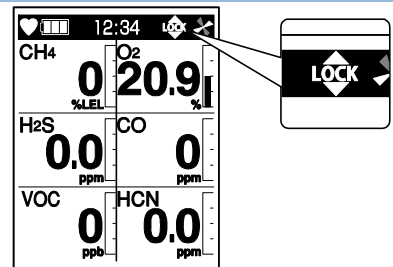

## Combustible gas sensor <%LEL> protection setting (only for the specification targeting combustible gas <%LEL> for detection)

The combustible gas sensor <%LEL> is turned off to protect it from contact with high-concentration combustible gases.

- 1 Press the DISP button to display the screen shown in the right figure, and then press the ENTER button.

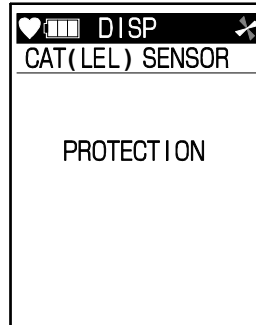

- 2 Select with the ▲/▼ button.  
Select the combustible gas sensor <%LEL> protection setting.

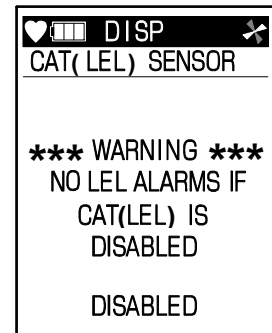
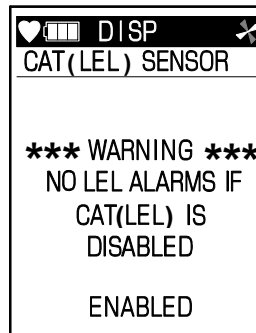

- 3 Press the ENTER button.  
When the setting is completed, the screen shown in the step 1 returns automatically.

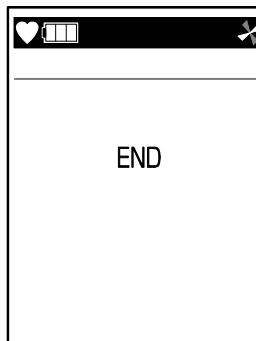

### NOTE

- With ON selected, [- - -] is displayed in the combustible gas <%LEL> concentration display area. Also, [NO ALARM] is displayed in the clock display area and the gas alarm function is disabled for all gases.

## LCD black and white inversion setting

This item is used to invert the black and white display of LCD.

- 1 Press the DISP button to display the screen shown in the right figure, and then press the ENTER button.

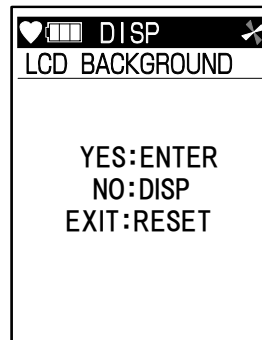

- 2 Select with the ▲/▼ button. Select the LCD black and white inversion setting. Press the DISP button to return to the screen shown in the step 1 without changing the setting.

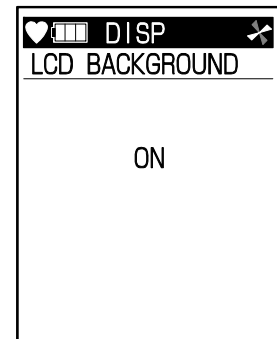
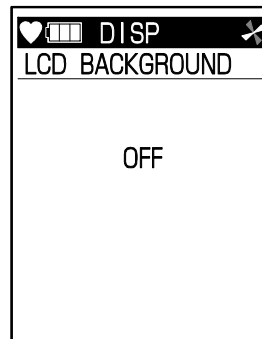

- 3 Press the ENTER button. When the setting is completed, the screen shown in the step 1 returns automatically.

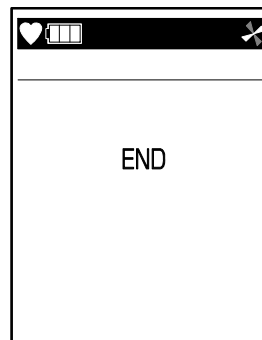

### NOTE

- The figure on the right shows an example of black and white inversion.

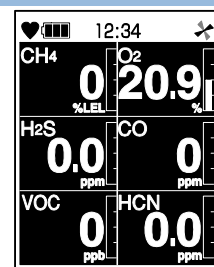

## English display setting

This item is used to resume English display when another language is used.

To correct erroneous language setting, resume English display once using this function and set again.

- 1 Press the DISP button to display the screen shown in the right figure, and then press the ENTER button.**

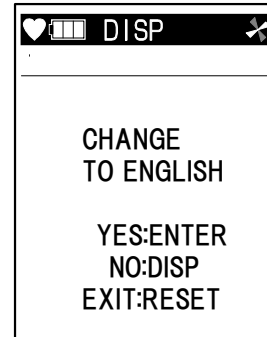

- 2 Press the ENTER button.**  
Press the DISP button to return to the screen shown in the step 1 without changing to English display.

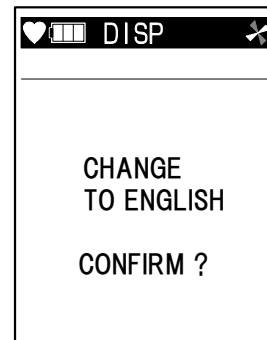

The displayed language is changed to English.  
When the setting is completed, the screen shown in the step 1 (displayed in English) is displayed automatically.

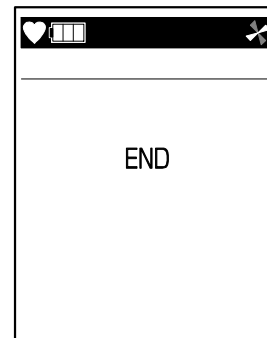

### NOTE

- The language setting can be changed in the user mode (P. 78) as well.

## 6-3. User mode setting

The display positions of date/time, gas concentration, etc. can be changed in the user mode to make them easier to use.

### Displaying user mode

- 1 **When the power is off, press the POWER button while pressing the ▲ and ▼ button.**

The screen to select user or maintenance mode is displayed.

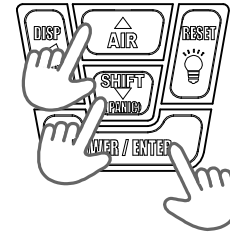

- 2 **Select [USER MODE] and press the ENTER button.**

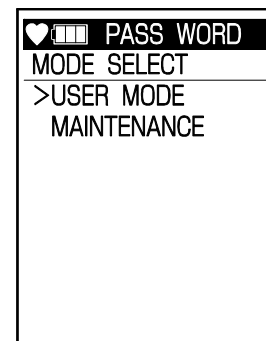

The user mode menu is displayed.

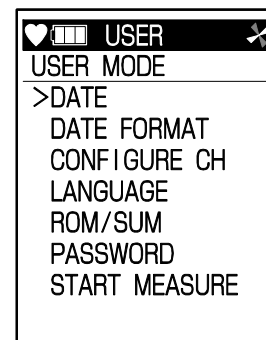

- 3 **When the setting is completed, select [START MEASURE] in the user mode menu and then press the ENTER button.**

The unit operates just like after turning on the power and goes on to the measurement screen.

### NOTE

- The user mode menu returns after setting various items. Press the DISP button to return in the process of setting.
- The maintenance mode is intended for important settings to perform normal measurement. This is unavailable for users to prevent an accidental change of settings. If the maintenance mode is selected accidentally, turn off the power once and then turn it on again.

## Setting date/time

This item is used to set date/time.

- 1 **Select [DATE] with the ▲/▼ button.**

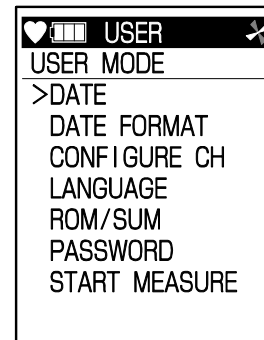

- 2 **Press the ENTER button.**  
The year portion (YYYY) blinks.  
Change numbers with the ▲/▼ button.

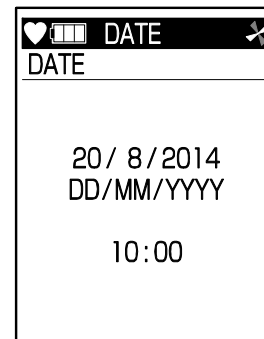

- 3 **When year is set, press the ENTER button.**  
The month portion (MM) blinks.  
Change numbers with the ▲/▼ button.  
Similarly, set day, hour and minute.  
Press the DISP button to go back to the previous portion like month to year.

- 4 **When minute is set, press the ENTER button.**  
When the setting is completed, the user mode menu returns automatically.

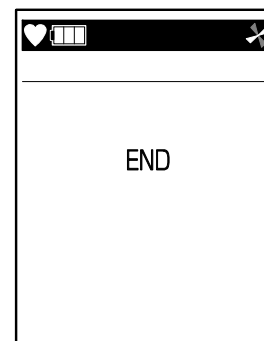

## Selecting date display format

A desired format can be selected from three options for date display.

- 1 **Select [DATE FORMAT] with the ▲/▼ button and then press the ENTER button.**

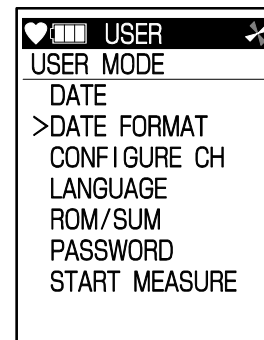

- 2 **Select display with the ▲/▼ button.**

[DD/MM/YYYY] indicates day/month/year.

[MM/DD/YYYY] indicates month/day/year.

[YYYY/MM/DD] indicates year/month/day.

Press the DISP button to return to the screen shown in the step 1 without changing the display format.

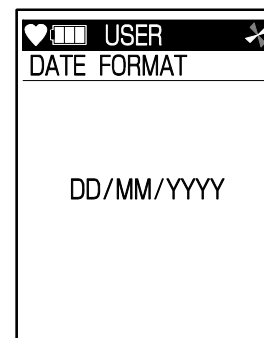

- 3 **Press the ENTER button.**

When the setting is completed, the user mode menu returns automatically.

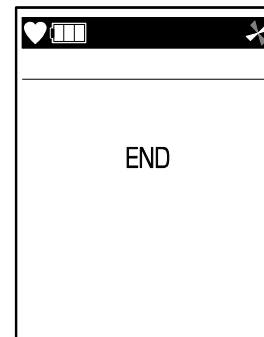



## Changing display positions of measured gases

The measured gas concentration display positions can be changed.

- Select [CONFIGURE CH] with the ▲/▼ button and then press the ENTER button.**

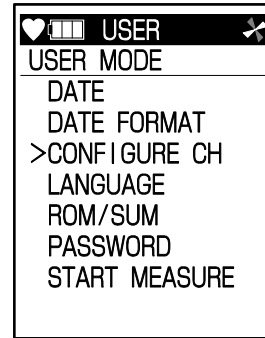

- Select the display position to change with the ▲/▼ button and then press the ENTER button.**  
Display positions of [CH1] - [CH6] are as follows.

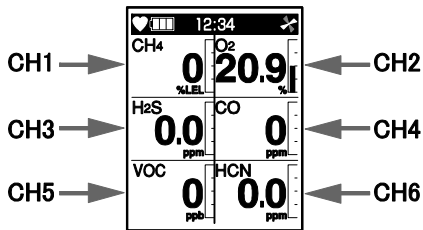

Use [ESCAPE] to return to the user mode menu.

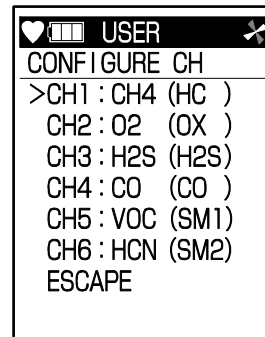

- Select the display to exchange with the ▲/▼ button.**

The display positions of the selected channel and the selected channel in the step 2 (blinking) are exchanged.

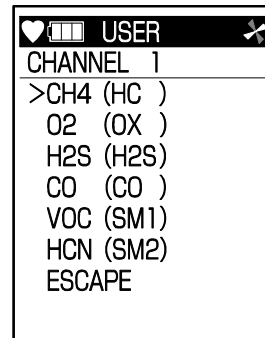

- Press the ENTER button.**

When the setting is completed, the screen shown in the step 2 returns automatically.

To return to the user mode menu, press the DISP button, or select [ESCAPE] and press the ENTER button.

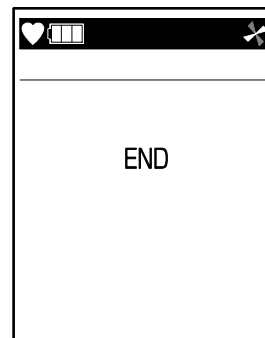

### NOTE

- The display of the same measured gas cannot be allocated to multiple CH positions.

## Changing display language

This item is used to change the language used on the LCD display.

- 1 **Select [LANGUAGE] with the ▲/▼ button and then press the ENTER button.**

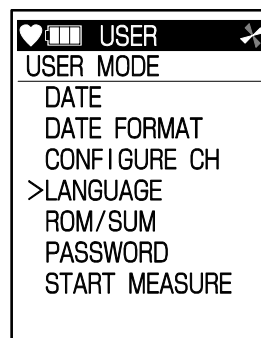

- 2 **Select language with the ▲/▼ button.**



- 3 **Press the ENTER button.**  
When the setting is completed, the display changes to the selected language and the user mode menu returns automatically.

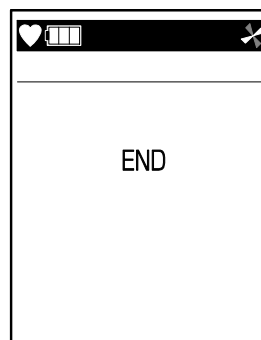

## Displaying ROM/SUM

This item is used to check ROM number and the version of error detection data (checksum) sent with data.

- 1 **Select [ROM/SUM] with the ▲/▼ button and then press the ENTER button.**

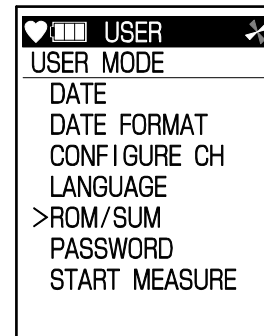

ROM number is displayed.

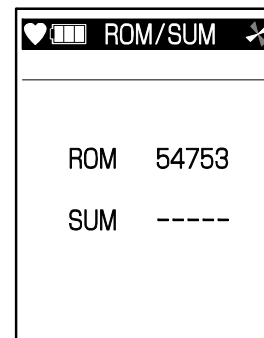

After calculation, SUM is displayed.

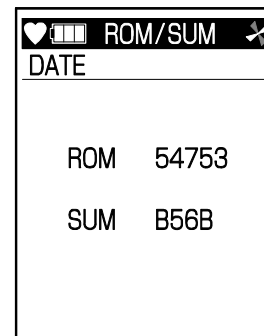

- 2 **Press the ENTER button.**  
The display ends and then the user mode menu returns automatically.

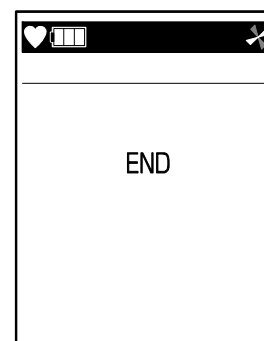

## Setting password

This item is used to set password to enter the user mode.

- 1 **Select [PASSWORD] with the ▲/▼ button and then press the ENTER button.**

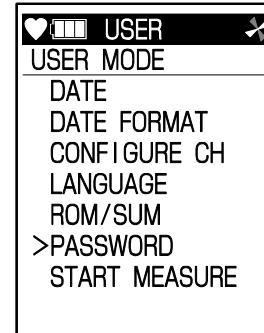

- 2 **Select [ON] with the ▲/▼ button and then press the ENTER button.**

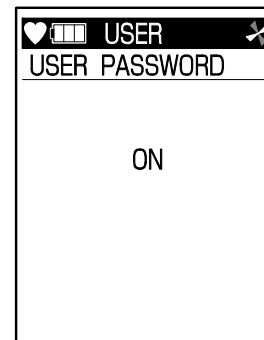

- 3 **Set a four-digit password.**  
The leftmost "0" blinks.  
Select a number from 0 to 9 with the ▲/▼ button and then press the ENTER button. The next digit will blink.

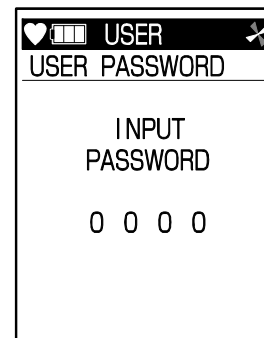

- 4 **Press the ENTER button.**  
When the setting is completed, the user mode menu returns automatically.

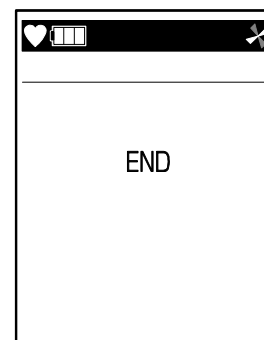

### NOTE

- With a password set, the password entry screen shown in the right figure appears before entering the user mode or CAL mode. Enter a password with the ▲/▼ button and then press the ENTER button.

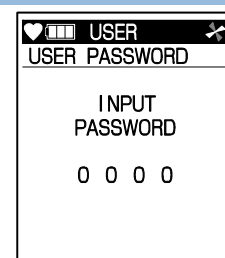

## 7

# Maintenance

The gas monitor is an important instrument for the purpose of safety. To maintain the performance of the gas monitor and improve the reliability of safety, perform a regular maintenance.

## 7-1. Maintenance intervals and items

Perform the following maintenance regularly before use.

- Daily maintenance: Perform maintenance before beginning to work.
- Monthly maintenance: Perform alarm test once a month.
- Regular maintenance: Perform maintenance once or more for every six months to maintain the performance as a safety unit.

Maintenance item	Maintenance content	Daily maintenance	Monthly maintenance	Regular maintenance
<b>Battery level</b>	Check that the battery level is sufficient.	○	○	○
<b>Concentration display</b>	Make the gas monitor draw in fresh air. Check that the concentration display value is zero (or 20.9 % on the oxygen meter). When the value is other than zero, perform zero adjustment by air calibration after ensuring that no interference gases exist around.	○	○	○
<b>Operation of main unit</b>	Check the LCD display for a fault indication.	○	○	○
<b>Pump operation</b>	Check the pump operation status display for a fault indication.	○	○	○
<b>Filter</b>	Check that the filter is not contaminated.	○	○	○
<b>Alarm test</b>	Perform alarm test and check that the alarm LED arrays, buzzer and vibrator function normally.	—	○	○
<b>Span adjustment</b>	Perform span adjustment using a calibration gas.	—	—	○
<b>Gas alarm check</b>	Check the gas alarm using a calibration gas.	—	—	○



### WARNING

- If any abnormality is found on the gas monitor, promptly contact RIKEN KEIKI.

**NOTE**

- Perform span adjustment using a calibration gas at least once every six months.
- The span adjustment requires dedicated equipment and creation of calibration gas. Therefore, contact RIKEN KEIKI for span adjustment.
- The built-in sensors of the gas monitor have a validity period and must be replaced regularly.
- The sensor life has expired if, for example, the sensors cannot be calibrated in span adjustment, the readings do not come back after air calibration, or the readings fluctuate. In this case, contact RIKEN KEIKI.

**About maintenance services****We provide services on regular maintenance including span adjustment, other adjustments and maintenance.**

To make the calibration gas, dedicated tools, such as a gas cylinder of the specified concentration and gas sampling bag must be used.

Our qualified service engineers have expertise and knowledge on the dedicated tools used for services, along with other products. To maintain the safety operation of the gas monitor, please use our maintenance service.

The followings are typical maintenance services. Please contact RIKEN KEIKI for more information.

**<Typical Maintenance Services>**

<b>Battery level check</b>	Checks the battery level.
<b>Concentration display check</b>	Verifies that the concentration display value is zero (or 20.9 % on the oxygen meter) using a zero gas. Performs air calibration (zero adjustment) if the reading is incorrect.
<b>Flow rate check</b>	Checks the flow rate by using an external flow meter.
<b>Filter check</b>	Checks the dust filter for dust or clogging. Replaces a dirty or clogged dust filter.
<b>Alarm test</b>	Performs alarm test to check that the alarm lamp, buzzer and vibrator function normally.
<b>Span adjustment</b>	Performs span adjustment using a calibration gas.
<b>Gas alarm check</b>	Checks the gas alarm using a calibration gas. <ul style="list-style-type: none"> <li>• Checks the alarm. (Checks triggering of alarm when the alarm setpoint is reached.)</li> <li>• Checks the delay time. (Checks time to delay until the alarm is triggered.)</li> <li>• Checks the buzzer, lamp, vibrator and concentration display. (Checks each activation of two-step alarm.)</li> </ul>
<b>Cleaning and repair of the unit (visual diagnosis)</b>	Checks dust or damage on the surface of the unit, cleans and repairs such parts. Replaces parts which are cracked or damaged.
<b>Unit operation check</b>	Operates the buttons to check the operation of functions and parameters.
<b>Replacement of consumable parts</b>	Replaces consumable parts, such as a sensor, filter and pump.

## 7-2. Calibration (CAL mode)

The CAL mode of the gas monitor provides AUTO CAL and SINGLE CAL in addition to AIR calibration. AUTO CAL performs calibration with the predetermined gas concentration, while SINGLE CAL performs calibration by setting gas concentration each time for a single channel.

The gas monitor is equipped with a bump test (function check) function; however, it is set to OFF normally and thus unavailable. To use this function, please contact RIKEN KEIKI.

Perform span adjustment of sensors using a calibration gas at least once every six months (recommendation).

The span adjustment requires dedicated equipment and a calibration gas. Contact RIKEN KEIKI for it.



### CAUTION

- Do not use a lighter gas to check the sensitivity of the gas monitor. A constituent of the lighter gas may deteriorate the sensor performances.

### 7-2-1. Preparation for calibration

#### <Required Equipment/Material>

- Calibration gas (optional)
- Gas sampling bag (optional)

#### <Connection>

To perform calibration, connect a gas sampling bag to the unit as shown below.

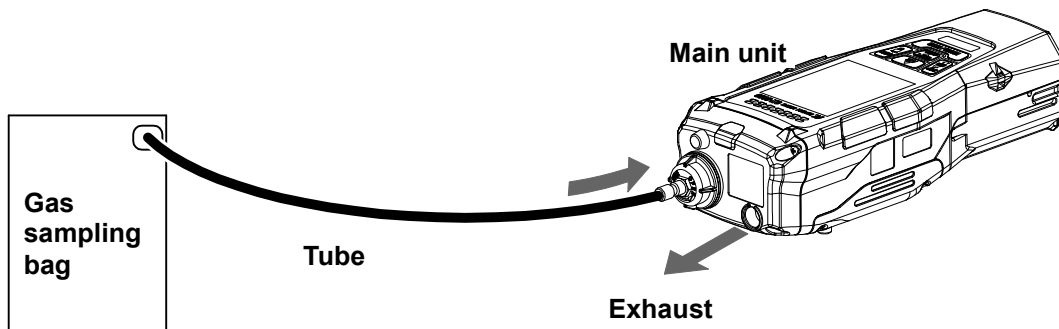



## WARNING

### Calibration gas

A calibration gas uses a hazardous gas (combustible gas, toxic gas, oxygen deficiency, etc.). Handle the gas and related jigs and tools with due care.

### Gas sampling bag

Use different gas sampling bags for each gas type and concentration to perform accurate calibration.

### Place for calibration

- Do not perform calibration in a confined space.
- Perform calibration in a place where no silicone, spray can gases, etc. is used.
- Perform calibration indoors at normal temperatures without remarkable fluctuation (within  $\pm 5$  °C).

### Calibration gas discharge

- The gas outlet of the gas monitor must be left open without any pipe connected for release. Discharge the gas to a safe place.
- A calibration gas uses a hazardous gas (combustible gas, toxic gas, oxygen deficiency, etc.). Discharge the gas with due care.

## 7-2-2. Entering CAL mode

- 1 With the measurement screen displayed in the normal mode, press the DISP and SHIFT buttons at the same time.

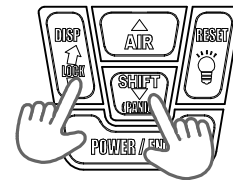

The CAL mode screen is displayed.

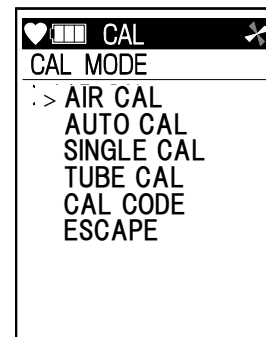

### NOTE

- Selecting [NORMAL MODE] returns to the measurement screen.
- Press the DISP button to return to the previous screen.



### 7-2-3. Air calibration (AIR CAL)

- 1 In the CAL mode, select [AIR CAL] with the ▲/▼ button and then press the ENTER button.

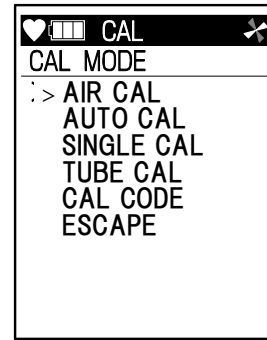

- 2 Hold down the AIR button.

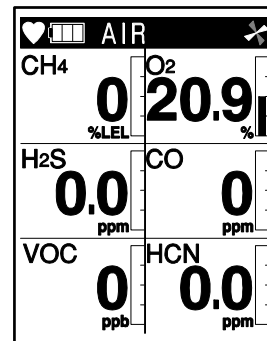

The air calibration screen is displayed.

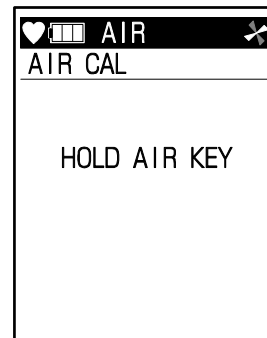

Keep the AIR button pressed while the screen shown in the right figure is displayed.

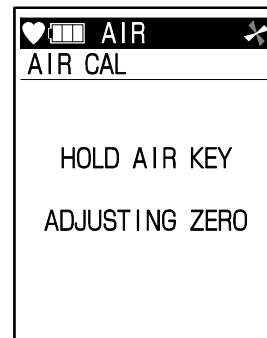

- 3 Release the AIR button when the screen shown in the right figure is displayed.

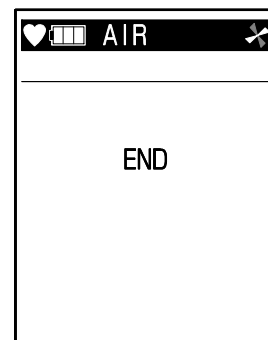
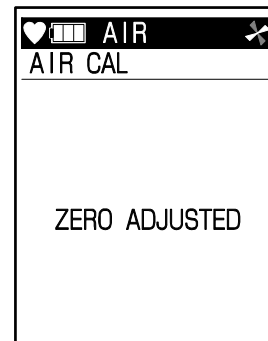
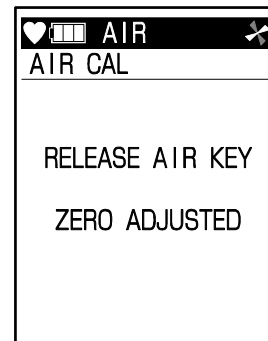

When zero adjustment is successfully completed, the screen shown in the step 2 returns. Press the DISP button to return to the CAL mode menu.



### WARNING

- When air calibration is performed in the atmosphere, check the atmosphere for freshness before beginning it. If interference gases exist, zero adjustment cannot be performed properly, thus leading to dangers when the gas leaks.



### CAUTION

- Perform air calibration under pressure and temperature/humidity conditions close to those in the operating environment and in fresh air.
- Perform air calibration after the reading is stabilized.

### NOTE

When air calibration fails, [FAIL] appears in the measured value display area of the faulty sensor as well as [SENSOR]. Press the RESET button to reset the fault alarm (calibration failure). When the alarm is reset, the value before calibration is displayed.

## 7-2-4. AUTO CAL

Calibration is performed using the predetermined gas concentration. Simultaneous calibration is available for the four channels: oxygen, combustible gas <%LEL> and toxic gases (carbon monoxide and hydrogen sulfide).

Prepare a calibration gas (P. 87).

- 1 In the CAL mode, select [AUTO CAL] with the ▲/▼ button and then press the ENTER button.

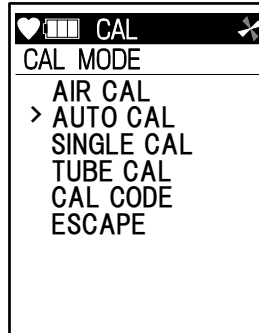

- 2 Select [CONCENTRATION] or [GAS SELECT] with the ▲/▼ button and then press the ENTER button.

- Setting gas concentration  
Select [CONCENTRATION] -> Go to step 3
- Selecting gas type  
Select [GAS SELECT] -> Go to step 4
- Canceling calibration  
Select [ESCAPE] -> Go to CAL mode menu

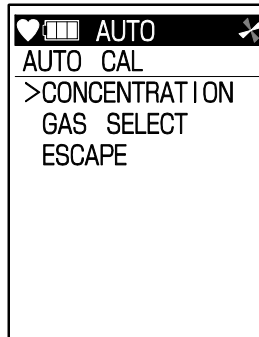

- 3 Select gas with the ▲/▼ button and then press the ENTER button.

The concentration value of the selected gas blinks.  
Select calibration gas concentration with the ▲/▼ button and then press the ENTER button to confirm it.  
Select [ESCAPE] to return to the screen shown in the step 2.

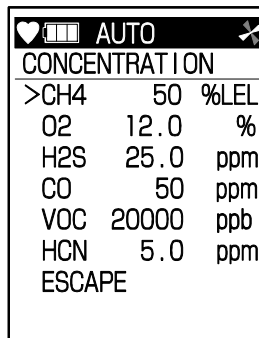

- 4 Select calibration target gas with the ▲/▼ button and then press the ENTER button.  
Simultaneous calibration is available for the four channels: oxygen, combustible gas <%LEL> and toxic gases (carbon monoxide and hydrogen sulfide).

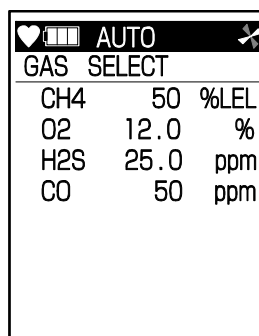

Calibration value are common for isobutylene and selected gas.

Select calibration gas isobutylene or selected gas from “List of gases for reading VOC”.  
See 'VOC reading setting' (P. 64)

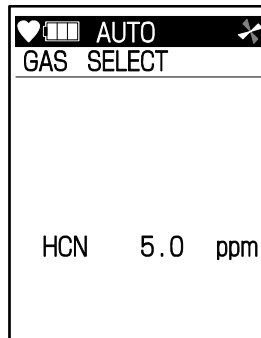
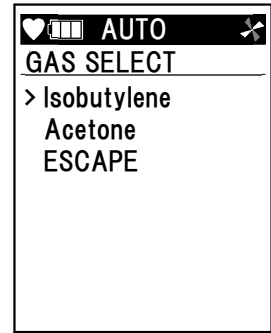
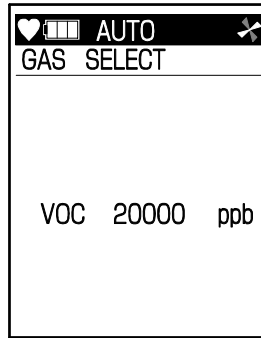

Select [ESCAPE] to return to the screen shown in the step 2.

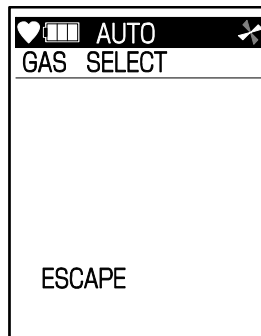

- 5 Make the gas monitor draw in the calibration gas from the gas inlet and press the ENTER button after 60 seconds.**

Calibration is executed.  
To stop the calibration process, press the DISP button to return to the screen shown in the step 4.

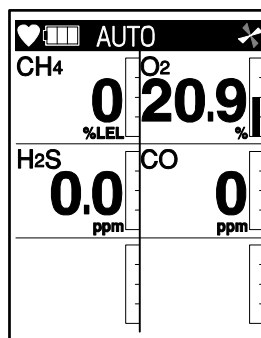

- 6 Press the DISP button.**  
The CAL mode menu returns after finishing AUTO CAL.

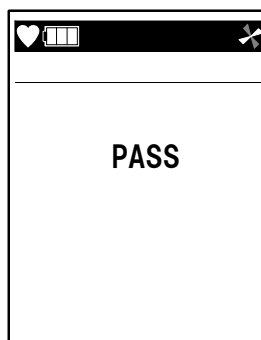

## 7-2-5. SINGLE CAL

Calibration is performed by setting gas concentration each time for a single channel. Prepare a calibration gas (P. 87).

- 1 In the CAL mode, select [SINGLE CAL] with the ▲/▼ button and then press the ENTER button.

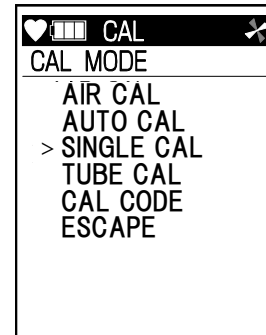

- 2 Select a sensor with the ▲/▼ button and then press the ENTER button.

Select [ESCAPE] to return to the screen shown in the step 2.

When select VOC, select calibration gas isobutylene or selected gas from 'List of gases for reading VOC'. See 'VOC reading setting' (P. 64)

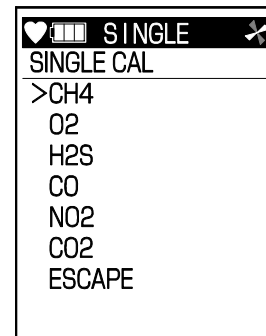

- 3 Make the gas monitor draw in the calibration gas from the gas inlet, and adjust the displayed gas concentration to the concentration of the calibration gas used with the ▲/▼ button.

Press the ENTER button 60 seconds after starting drawing in the gas to execute calibration.

To stop the calibration process, press the DISP button to return to the screen shown in the step 4.

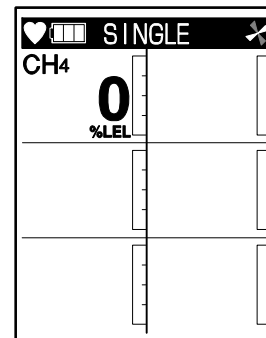

- 4 Press the DISP button.

The CAL mode menu returns after finishing [SINGLE CAL].

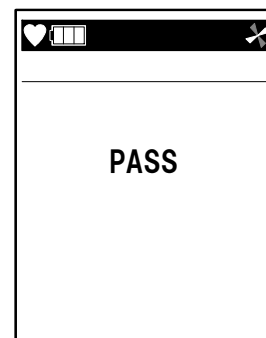

## 7-2-6. TUBE CAL (only for the specification with VOC<10.0eV>sensor )

Calibration is performed with Pre-Filert Tube (CF-8338) and Tube holder (GF-284) (optional) for Benzene Select mode. See 'Attaching Pre-Filter Tube (CF-8338) and Tube holder (GF-284) (optional)' (P.33).

- 1 In the CAL mode, select [TUBE CAL] with the ▲/▼ button and then press the ENTER button.

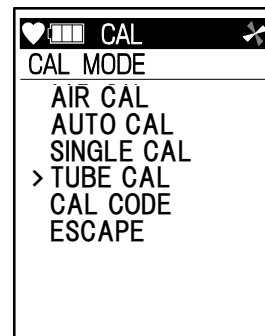

- 2 Install the Pre-Filter Tube(CF-8338) and Tube holder(GF-284), and then press the ENTER button.

Press the DISP button to return to the screen shown in the step 1.

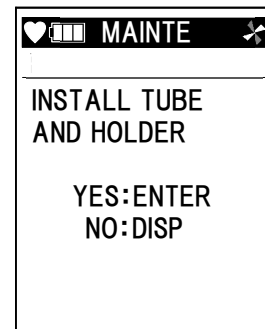

- 3 Select [AUTO CAL] or [SINGLE CAL] with the ▲/▼ button and then press the ENTER button.

•[AUTO CAL]: Calibration is performed using the predetermined gas concentration.

- Setting gas concentration -> Go to step 4
- Performing [AUTO CAL] -> Go to step 5

•[SINGLE CAL]: Calibration is performed by setting gas concentration each time for a single channel.

- Performing [SINGLE CAL] -> Go to step 8

•Returning to [CAL MODE] -> Step 11

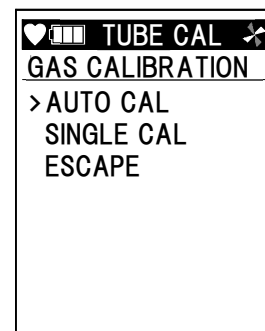

- 4 Select [CONCENTRATION] with the ▲/▼ button and then press the ENTER button.

Select calibration gas concentration with the ▲/▼ button and then press the ENTER button to confirm it.

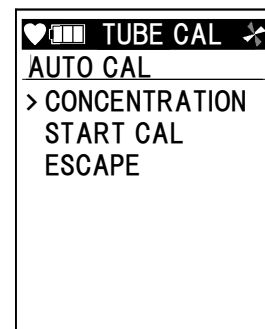

- 5 Select [START CAL] with the ▲/▼ button and then press the ENTER button.

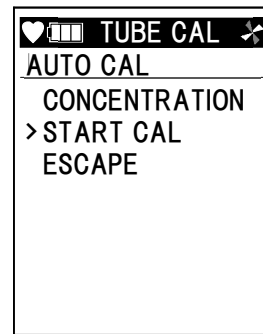

- 6 Pump starts, and then calibration starts. Countdown is shown in the display. Calibration time varies depending on temperature. See the following list about the calibration time. The number in the list is shown in the bottom left corner of the display.

1.	-20.0	-	-10.1 °C	:135 seconds
2.	-10.0	-	-0.1 °C	:110 seconds
3.	0.0	-	+9.9 °C	: 90 seconds
4.	+10.0	-	+19.9 °C	: 70 seconds
5.	+20.0	-	+29.9 °C	: 45 seconds
6.	+30.0	-	+50.0 °C	: 35 seconds

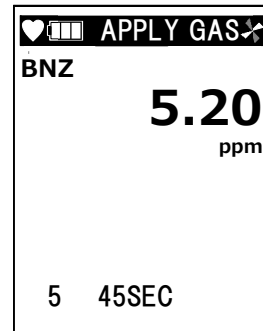

- 7 Press the DISP button. The CAL mode menu returns after finishing TUBE CAL.

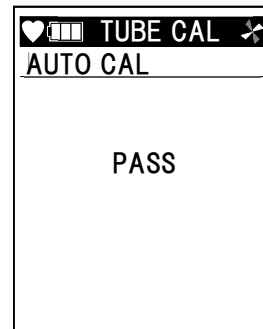

- 8 Select [SINGLE CAL] with the ▲/▼ button and then press the ENTER button.

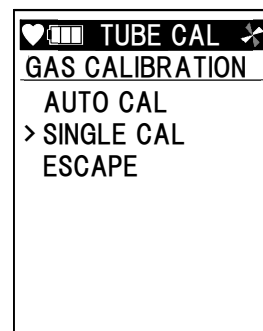

- 9 Make the gas monitor draw in the calibration gas from the gas inlet, and adjust the displayed gas concentration to the concentration of the calibration gas used with the ▲/▼ button.

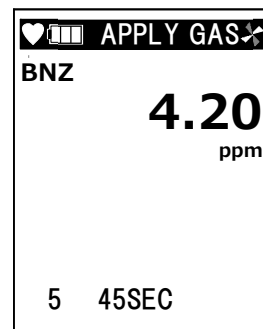

- 10 Press the ENTER button after the countdown is finished.**

The CAL mode menu returns after finishing TUBE CAL.

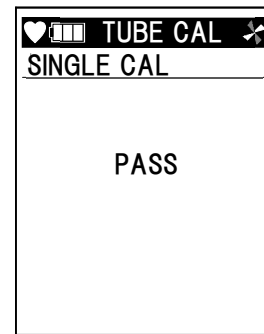

- 11 Select [ESCAPE] with the ▲/▼ button and then press the ENTER button to return to the CAL mode menu.**

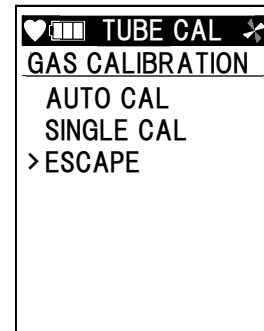

- 12 Remove the Tube holder, and then press the ENTER button.**

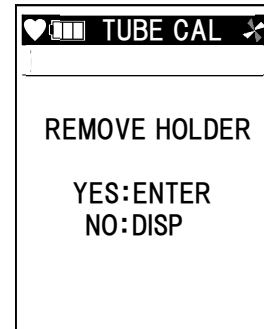



## 7-2-7. BUMP TEST

The gas monitor is equipped with a bump test (function check) function; however, it is set to OFF normally and thus unavailable.

To use this function, please contact RIKEN KEIKI.

Simultaneous execution of bump test is available for the four channels: oxygen, combustible gas <%LEL> and toxic gases (carbon monoxide and hydrogen sulfide). Prepare a bump test gas as in the case of calibration gas (P. 87).

- 1 **Select [BUMP TEST] with the ▲/▼ button and then press the ENTER button.**

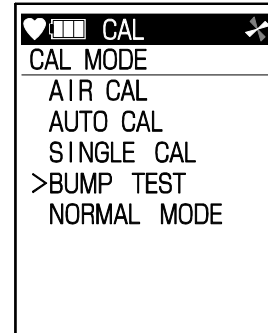

- 2 **Select the gas to be tested with the ▲/▼ button.**

Simultaneous testing is available for the four channels: oxygen, combustible gas <%LEL> and toxic gases (carbon monoxide and hydrogen sulfide).

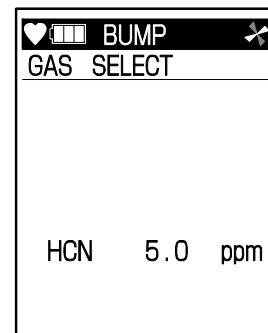
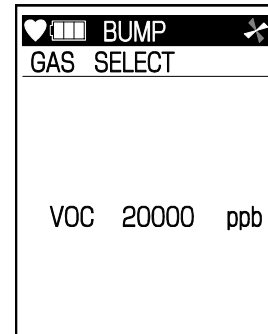
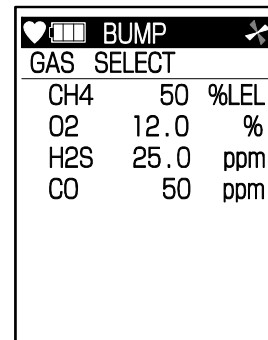

Select [ESCAPE] to return to the CAL mode menu.

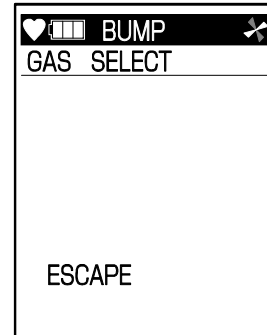

**3 Make the gas monitor draw in the test gas from the inlet and press the ENTER button.**

BUMP TEST starts and a 30-second countdown starts.

To stop the process, press the DISP button to return to the screen shown in the step 4.

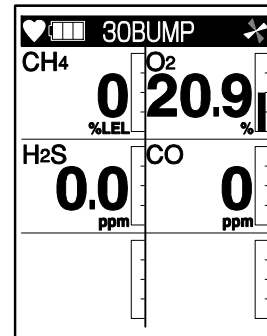

After 30 seconds, the result of [BUMP TEST] is displayed.

If the result of [BUMP TEST] is [NG], calibration is started automatically. Check that calibration has been performed accurately for all gases and [OK] has been displayed before use.

If NG is displayed as a result of calibration, replace the sensor (P. 102).

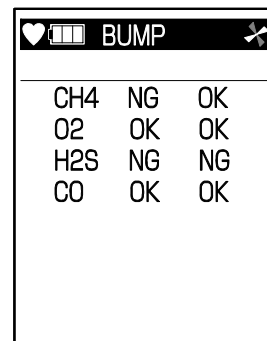

**4 Press the DISP button.**

The CAL mode menu returns after finishing [SINGLE CAL].

## 7-3. How to clean

Clean the gas monitor if it becomes extremely dirty. The gas monitor must be turned off while cleaning it. Use a waste cloth or the like to remove dust. Do not use water or organic solvent for cleaning because they may cause malfunctions.

Because an extremely contaminated taper nozzle may disturb the gas detection, it must be cleaned with dry air, etc.



### CAUTION

- When cleaning the gas monitor, do not splash water over it or use organic solvents such as alcohol and benzene on it. It may cause discoloration or damage to the surface or sensor failure.

### NOTE

- When the gas monitor gets wet, water may remain in the buzzer sound opening or grooves. Drain water as follows:
  - (1) Wipe away moisture on the gas monitor thoroughly using a dry towel, cloth, etc.
  - (2) While holding the gas monitor firmly, shake it about ten times with the buzzer sound opening facing downward.
  - (3) Wipe away moisture coming out from the inside thoroughly using a towel, cloth, etc.
  - (4) Place the gas monitor on a dry towel, cloth, etc. and let it stand at normal temperatures.

## 7-4. Parts replacement

### 7-4-1. Gas inlet filter replacement

The gas inlet part contains a dust filter and wire mesh filter. Because the filters may gradually get dirty or clogged over time, they must be replaced according to the operating conditions. Especially the dust filter must be replaced when it shows a sign of water absorption, low flow rate or contamination. See the regular replacement parts (P. 107) for a replacement filter.

- 1 Turn the filter case counterclockwise and remove it.
- 2 Take out the filter and replace with a new filter.
- 3 Attach the filter case that has been removed.

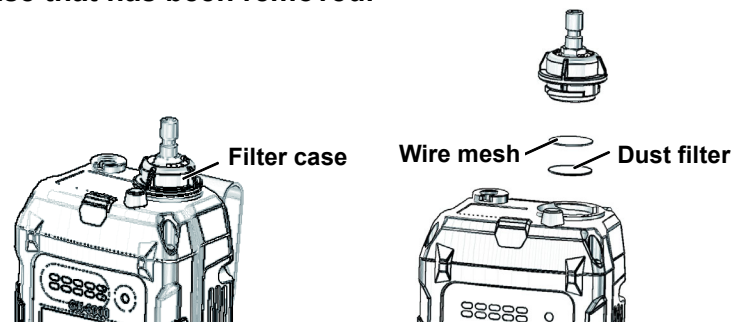

#### NOTE

- The dust filter and wire mesh filter are attached to the main unit side.
- Use only the filters specified by RIKEN KEIKI.

## 7-4-2. Sensor filter replacement

The sensor part contains various filters. Replace them regularly. See the regular replacement parts (P. 107) for a replacement filter.

- 1 Remove the battery unit, loosen the four screws of the sensor cover and remove the sensor cover.

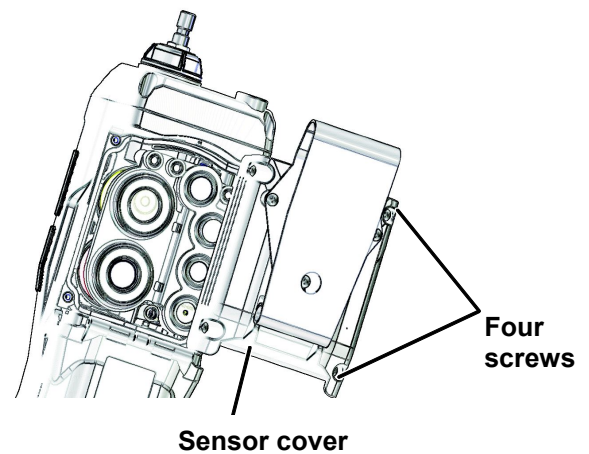

- 2 Take out filters and replace them with new ones.

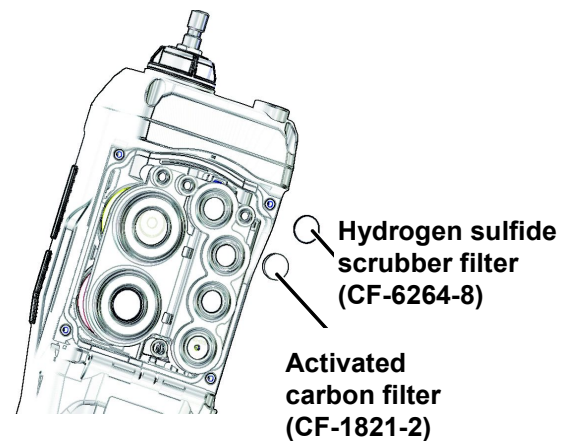

- 3 Attach the sensor cover to the main unit and tighten the four screws.



### CAUTION

- Turn off the power of the gas monitor before replacing the filter.
- Do not remove the sensor cover except for filter replacement. When the sensor cover is not attached properly, accurate measurement may not be possible due to leaks, or water may get inside.
- Use the dedicated filters for this gas monitor only. Using a similar product may have harmful effects on the gas detection performance.
- If the screws are not tightened completely, accurate gas measurement may not be possible due to leaks, or water may get inside. The same thing may occur if a minute foreign substance gets stuck.

### 7-4-3. Sensor replacement

The built-in sensors of the gas monitor have a validity period and must be replaced regularly. The sensor life has expired if, for example, the sensors cannot be calibrated in span adjustment, the readings do not come back after air calibration, or the readings fluctuate. Replace them as necessary. See 'Regular replacement parts' (P. 107) for recommended replacement intervals of sensors.

- 1 Remove the four screws at the back of the main unit and remove the sensor cover.

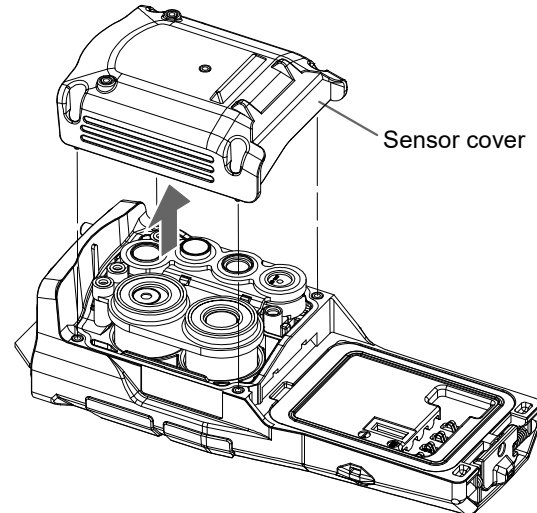

- 2 Remove the hydrogen sulfide scrubber filter and activated carbon filter from the rubber seal.

Hydrogen sulfide scrubber Filter

Activated carbon filter

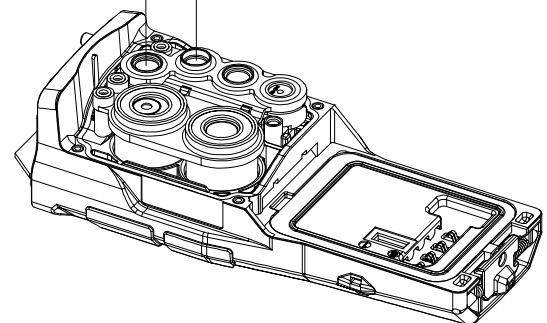

- 3 Remove the rubber seal.

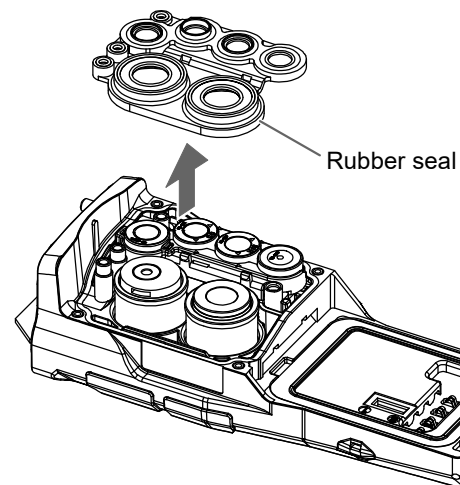

#### 4 Replace the sensor.

Attach a new sensor to the position where the old sensor was mounted. Attach the sensor according to the following instructions.

- **Combustible gas sensor <%LEL>**  
The contact piece on the side of the sensor comes in contact with the contact piece of the main unit.
- **CO and H<sub>2</sub>S sensors**  
The triangle marks (▲) on the sensor and main unit are facing each other.
- **Arbitrarily selected sensor (1) and (2)**  
The connector at the back of the sensor is inserted to the connector of the main unit.

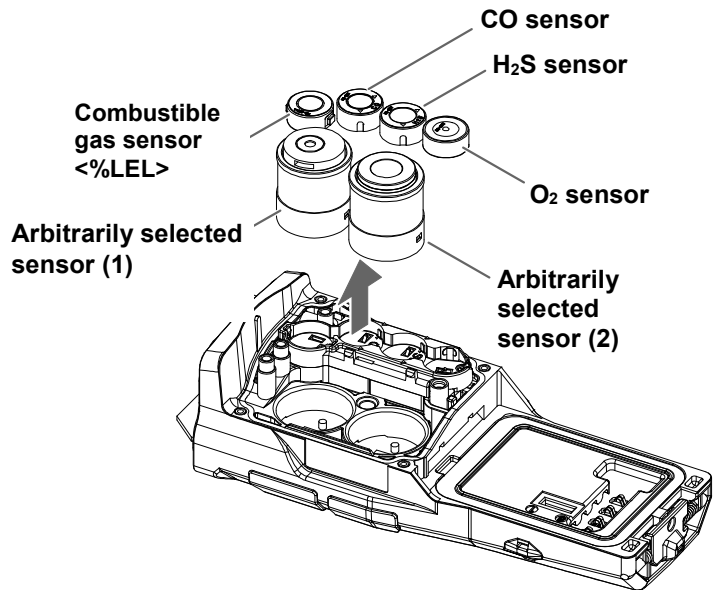

#### 5 Attach the rubber seal, new hydrogen sulfide scrubber filter and activated carbon filter, and then fix the sensor cover by tightening the four screws.

To attach the rubber seal, hang it on the tabs (two locations) of the case and push it against the holes (three locations) of the case to fix.

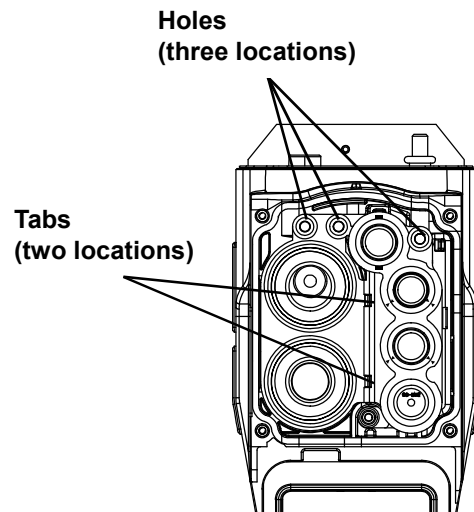

### CAUTION

- Turn off the power of the gas monitor before replacing the sensor and the filter.
- When replacing a sensor, replace the sensor filter as well.
- Use only the filters specified by RIKEN KEIKI.
- Do not touch the filters for NO<sub>2</sub> sensor and SO<sub>2</sub> sensor by hand. These filters may be discolored. If the filters are touched by hand, be sure to wash the hands. When the color changes remarkably, the discoloration may cause the sensor sensitivity to be low.
- Never fail to perform calibration (P. 87) after sensor replacement.

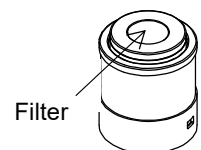

Side view of  
NO<sub>2</sub> and SO<sub>2</sub> sensor

### NOTE

- The mounted sensors vary by the specification.
- To replace a sensor, be sure to attach a new sensor to the position where the old sensor was attached. If a sensor is attached to a wrong position, [SENSOR FAIL] is displayed or correct measurement cannot be performed.
- If the mounting position of the arbitrarily selected sensor is lost, attach the VOC sensor <10.6eV/ppb>, VOC sensor <10.0eV>, VOC sensor <10.6eV/ppm>, Cl<sub>2</sub> sensor, NH<sub>3</sub> sensor and other sensor in this order to the arbitrarily selected sensor (1) mounting position and arbitrarily selected sensor (2) mounting position. If the sensor is attached in the wrong order, [SENSOR FAIL] is displayed and measurement becomes unavailable.

## 7-4-4. VOC sensor maintenance

The electronics in VOC sensor are designed to be maintenance-free and not accessible. Periodic sensor maintenance is required for the Mini Pellet and the lamp.

### When does my VOC sensor require maintenance?

Your PID lamp will need cleaning from time to time. How often depends on the environment you are measuring. If you are measuring indoor air quality where the VOC concentrations are low and there are few particulates, then a monthly or even less frequent calibration may be adequate. However, if you are measuring high VOC concentrations and particulates are present in high concentration then check calibration frequently and when the PID has lost sensitivity or error state shows, change the pellet as explained below.

Signs when the PID needs attention:

- If the baseline climbs after you zero the PID, then the pellet needs replacing.
- If the PID becomes sensitive to humidity, then the pellet needs replacing.
- If the baseline shifts/unstable when PID moves, then pellet needs replacing.
- If sensitivity has dropped too much (note the change required when checking calibration), then the lamp needs cleaning.



### When do I clean the PID lamp?

Cleaning of the PID lamp is recommended as a first action when presented with an PID that needs cleaning. Use the procedure described below. It is recommended that a cell is recalibrated after cleaning a lamp, especially if the cell has been used for a few months since the sensor was last used.

### When do I replace the PID electrode pellet?

The MiniPID pellet can last the lifetime of the MiniPID if used in clean environments, or may only last a month if used in heavily contaminated sites. The pellet is a disposable item, so always hold a spare pellet if you are working in a dirty environment. If the cell shows signs of contamination after the lamp window has been cleaned, or is known to have been subjected to severe contamination, then it should be replaced. Instructions for replacing the pellet are below. It is recommended that the MiniPID is recalibrated after replacing the pellet.

### When do I replace the PID lamp?

An PID lamp will last a long time, typically a few thousand hours. The sensitivity of the VOC sensor is approximately in direct proportion to the lamp light intensity, so as a bulb fails, the response to a particular, low gas concentration becomes more noisy.

Validity of lamp warranty is compromised if lamp cleaning maintenance is not followed and lamp has obvious fouling/contamination.

### Removing Electrode Pellet and PID Lamp

Caution: Always use the Pellet removal tool. Any other tools (for example screwdrivers) may damage your VOC sensor body.

1. Gently remove the sensor from equipment.
2. Place the VOC sensor, pellet side down, onto a clean surface.
3. Locate pellet removal tool into the side slots of the VOC sensor and squeeze together until pellet and lamp are released.
4. Lift carefully the VOC sensor body away from the pellet and lamp.
5. Occasionally the lamp may be temporarily lodged in the cell and will need to be freed carefully with tweezers.
6. Occasionally the small spring behind the lamp will come out when the lamp is removed from the sensor. Simply replace it in to the sensor house.

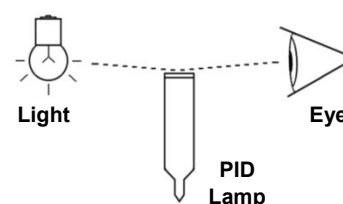



### Cleaning the PID Lamp

Inspection of the lamp may reveal a layer of contamination on the detection window that presents itself as a 'blue hue.' To check for contamination, hold the PID lamp in front of a light source and look across the window surface

Only clean the lamp using our recommended lamp cleaning kit and detailed instructions. To avoid contaminating the sensor and affecting accuracy, do not touch the lamp window with bare fingers. You may touch the lamp body with clean fingers.

### PID lamp cleaning kit

The vial of cleaning compound contains alumina (CAS Number 1344-28-1) as a very fine powder. Cleaning should be undertaken in a well-ventilated area. A full material safety data sheet MSDS is available on request from RIKEN KEIKI. Key safety issues are identified below:

#### Hazard identification:

- May cause irritation of respiratory tract and eyes

#### Storage:

- Keep container closed to prevent water adsorption and contamination.

#### Handling:

- Do not breathe in the powder. Avoid contact with skin, eyes and clothing
- Wear suitable protective clothing
- Follow industrial hygiene practices: Wash face and hands thoroughly with soap and water after use and before eating, drinking, smoking or applying cosmetics.
- The powder carries a TVL (TWA) limit of 10 mg/m<sup>3</sup>

### Cleaning the PID Lamp

Use of PID lamp cleaning kit

1. Open the container of alumina polishing compound.
2. With a clean cotton bud, collect a small amount of the powder.
3. Use this cotton bud to polish the PID lamp window. Use a circular action, applying light pressure to clean the lamp window. Do not touch the lamp window with fingers.
4. Continue polishing until an audible "squeaking" is made by the cotton bud moving over the window surface. (usually within 15 seconds)
5. Remove the residual powder from the lamp window with a clean cotton bud. Care must be taken not to touch the tips of cotton buds that are to be used to clean the lamps as this may contaminate them with finger print oil.
6. Ensure the lamp is completely dry and any visible signs of contamination are removed before refitting.



### Discarding the Electrode pellet

Discard the contaminated pellet. The pellet does not have any toxic components, but if it has been contaminated by toxic materials, then show due care when disposing.

---

**Re-fitting Electrode pellet and PID lamp****Caution! Never refit a damaged lamp**

1. Place the lamp inside the O-ring seal in the pellet as illustrated. Twisting the lamp slightly during insertion will help to ensure the lamp window is snug against the pellet's front electrode. The lamp should be freely supported by the O-ring.
2. Lay the pellet front face down on a clean, flat surface and then screw the lamp down into the O-ring until it firmly abuts against the front electrode face – this is most important. Then bring the MiniPID body carefully down over the lamp so as not to disturb its positioning within the pellet and then push the body firmly onto the face down pellet so that it clicks into place.
3. Refit the sensor into the sensing equipment.
4. Re-calibrate the equipment in accordance with manufacturer's instructions.



## 7-4-5. Regular replacement parts

Consumable parts of the gas monitor are listed below. Replace the consumable parts according to the recommended intervals.

### <List of Recommended Replacement Parts>

Name	Quantity	Remarks
Activated carbon filter (CF-1821-2)	1	Used for CO sensor. Recommended check intervals : 3 months Recommended replacement intervals : 6 months
Activated carbon filter (CF-8350)	1	Used for VOC sensor. (Only for the specification targeting VOC for detection) Recommended check intervals : 6 months Recommended replacement intervals : 1 year
Activated carbon filter (CF-8501)	1	Used for VOC sensor. (Only for the specification targeting VOC and CO <sub>2</sub> for detection) Recommended check intervals : 6 months Recommended replacement intervals : 1 year
Hydrogen sulfide scrubber filter (CF-6264-8)	1	Used for combustible gas sensor (%LEL). Recommended check intervals : 3 months Recommended replacement intervals : 6months
Dust filter	1	Recommended check intervals : 3 months Recommended replacement intervals : 6months
Wire mesh	1	
CO <sub>2</sub> removal filter (CF-284)	1	Used for CO <sub>2</sub> sensor. Recommended check intervals : 6 months Recommended replacement intervals : 1 year
HC/CH <sub>4</sub> sensor <%LEL> (NC-6264AZP)	1	
O <sub>2</sub> sensor (OS-BM2C)	1	
H <sub>2</sub> S sensor (ES-1827i)	1	
CO sensor (ES-1821)	1	
SO <sub>2</sub> sensor (ESS-03DH)	1	
NO <sub>2</sub> sensor (ESS-03DH)	1	
HCN sensor (ESS-03DH)	1	
NH <sub>3</sub> sensor (ESS-B332)	1	
Cl <sub>2</sub> sensor (ESS-B335)	1	
CO <sub>2</sub> sensor (DES-3311-1)	1	
HC sensor (DES-3311-2)	1	
VOC sensor <ppb> (PIS-001A)	1	
VOC sensor <ppm>(PIS-002A)	1	
PID lamp (10.6 eV)	1	Used for VOC sensor.
Electrode pellet <10.6eV/ppb>	1	Used for VOC sensor <10.6eV/ppb>.
Electrode pellet <10.6eV/ppm>	1	Used for VOC sensor <10.6eV/ppm>.
Electrode pellet <10.0eV>	1	Used for VOC sensor <10.0eV>.
CO <sub>2</sub> sensor<vol%> (DES-3311-1)	1	
HC sensor <%LEL / vol%> (DES-3311-2)	1	

<b>CH<sub>4</sub> sensor &lt;%LEL / vol%&gt; (DES-3311-3)</b>	1	
<b>CO<sub>2</sub> sensor&lt;ppm&gt; (DES-3311-4)</b>	1	
<b>Pump unit (RP-12)</b>	1	Recommended check intervals : 6 months Recommended replacement intervals : 1 - 2 years
<b>Rubber seals</b>	1 set	Recommended replacement intervals : 2 years *
<b>Lithium ion battery unit (BUL-6000)</b>	1	For customers who use the lithium ion battery unit. Recommended replacement intervals : About 500 cycles of charging and discharging
<b>Alkaline dry battery</b>	3	For customers who use the alkaline battery unit. AA type.

- \* The operation must be checked after replacement by a qualified service engineer. For the stable operation of the unit and safety, ask a qualified service engineer to take care of replacement of the part. Request it from RIKEN KEIKI.

## NOTE

- The above replacement intervals are recommendation only. The intervals may change depending on the operating conditions. These intervals do not mean the warranty periods either. The result of the regular maintenance may determine when to replace the parts.

---

## 8

---

# Storage and Disposal

## 8-1. Procedures to store the gas monitor or leave it for a long time

The gas monitor must be stored under the following environmental conditions.

- In a dark place under the normal temperature and humidity away from direct sunlight
- In a place where gases, solvents or vapors, etc. are not present

Store the gas monitor in a shipping carton, if any, in which the product was delivered.  
Store the gas monitor away from dust, etc. if the shipping carton is not available.



### CAUTION

- If the gas monitor is not used for a long time, store it after removing the lithium ion battery unit. Or remove dry batteries when the dry battery unit is used. Leaks from dry batteries may result in fire or injury.
- If the gas monitor is not used for a long time, turn on the power at least once every six months and check that the pump draws in air (about three minutes). The gas monitor, when not activated for a long time, may cease to work because of hardening of the grease in the pump motor.

### NOTE

- If the gas monitor with the lithium ion battery unit attached is not used for a long time, it is recommended to store it after discharging the batteries until the battery level icon shows one battery mark or so. If the gas monitor is stored with the batteries fully charged, the batteries get deteriorated more quickly and may have shorter life.
- If the gas monitor with the dry battery unit attached is not used for a short time, store it with dry batteries attached. Since the sensor of the gas monitor is energized at all times including power-off time, it is required to keep dry batteries attached for storage.

## 8-2. Procedures to use the gas monitor again

When using the gas monitor after storage, perform calibration.



### CAUTION

- Contact RIKEN KEIKI for readjustment including calibration.
- If there is a sudden temperature change of 15 °C or more between the storage and operational locations, turn on the power of the gas monitor, let it stand for about 10 minutes in a similar environment to the operational location, and perform air calibration in fresh air before using it.

## 8-3. Disposal of products

When the gas monitor is disposed of, it must be treated properly as an industrial waste in accordance with the local regulations.



### WARNING

- Do not disassemble the electrochemical type sensor or galvanic cell type sensor because they contain electrolyte. Electrolyte may cause severe skin burns if it contacts skin, while it may cause blindness if it contacts eyes. If electrolyte is adhered on your clothes, that part on your clothes is discolored or its material is decomposed. If contact occurs, rinse the area immediately with a large quantity of water. Dispose of dry batteries in accordance with procedure specified by the local authority.

### <Disposal in EU Member States>

When disposing of the gas monitor in EU member states, sort the batteries as specified. Handle the batteries removed from the lithium ion battery unit (BUL-6000) or dry batteries used for the dry battery unit (BUD-6000) according to the classified refuse collection system and recycling system based on the regulations of EU member states.

### NOTE

#### Crossed-out recycle dustbin mark

- This symbol mark is indicated on the products which contain the batteries which fall under EU Battery Directive 2006/66/EC. Such batteries need to be disposed of as specified by the latest Directive. This symbol mark indicates that the batteries need to be separated from the ordinary waste and disposed of appropriately.



## 9

# Troubleshooting

The troubleshooting does not explain the causes of all the malfunctions which may occur on the gas monitor. This simply helps to find the causes of malfunctions which may frequently occur. If the gas monitor shows a symptom which is not explained in this manual, or still has malfunctions even though remedial actions are taken, please contact RIKEN KEIKI.

## 9-1. Abnormalities on unit

Symptoms <Screen display>	Causes	Actions
<b>The power cannot be turned on.</b>	The battery level is too low.	Lithium ion battery unit: Charge in a safe place. Dry battery unit: Replace all the three dry batteries with new ones in a safe place.
	The POWER button was not pressed enough.	For power-on, press the POWER button and release it when the buzzer blips.
	Improper installation of the battery unit	Check whether the battery unit is properly attached to the main unit.
<b>Abnormal operations</b>	Disturbances by sudden static electricity noise, etc.	Turn off the power once and then turn it on again (restart).
<b>Cannot operate the gas monitor.</b>	Disturbances by sudden static electricity noise, etc.	Remove the battery unit in a safe place. Then reinstall it and turn on the power to perform operations.
<b>A low battery voltage alarm is displayed. [FAIL BATTERY]</b>	The battery level is low.	Lithium ion battery unit: Turn off the power and charge it in a safe place.
		Dry battery unit: Turn off the power and replace the dry batteries with new ones in a safe place.
<b>The batteries cannot be charged. (Lithium ion battery unit only)</b>	The charger is not connected properly.	Connect the AC plug and DC plug of the AC adapter properly.
	A charging circuit abnormality occurred.	Request the dealer or Riken Keiki local representative for repair.
	The batteries have been fully charged.	When fully charged batteries are charged again, the charging indicator lamp does not go on.
<b>A low flow rate alarm is displayed. [FAIL LOW FLOW]</b>	Water, oil or the like is drawn.	Check the taper nozzle for any damage or mark of drawn water, oil, etc.
	The filter is clogged.	Check the filter for attachment condition, clogging, torsion, etc.

Symptoms <Screen display>	Causes	Actions
<b>A low flow rate alarm is displayed.</b> [FAIL LOW FLOW]	The pump has deteriorated.	Request the dealer or Riken Keiki local representative to replace the pump.
	The unit was stored for a long time without being used (six months or longer).	When the low flow rate alarm is displayed, turn off the unit once and then turn it on again (restart). Repeat this procedure several times. If the problem still persists, request RIKEN KEIKI to replace the pump.
<b>Air calibration impossible</b> [SENSOR FAIL]	Fresh air is not supplied around the gas monitor.	Supply fresh air.
	Deteriorated sensor sensitivity	Replace the sensor with new one. (P. 102)
<b>Sensor abnormalities</b> [SENSOR FAIL]	Deteriorated sensor sensitivity	Replace the sensor with new one. (P. 102) (If [FAIL] is displayed in place of measured value at power-on, the alarm can be reset by pressing the RESET button. The operation can be continued using only the normal sensors to detect other gases.)
	The sensor mounting position is incorrect.	Mount the sensor properly. (P. 102)
	(VOC sensor) The PID lamp is contaminated.	Clean the PID lamp. (P. 103)
	(VOC sensor) Deteriorated electrode pellet	Replace the electrode pellet with new one. (P. 103)
	(VOC sensor) Deteriorated PID lamp	Replace the PID lamp with new one. (P. 103)
<b>System abnormalities</b> [FAIL SYSTEM]	A circuit abnormality occurred.	Request Riken Keiki for repair.
<b>Error No. 000</b>	Abnormalities of internal ROM	
<b>Error No. 010</b>	Abnormalities of internal RAM	
<b>Error No. 021</b>	Abnormalities of internal FRAM	
<b>Error No. 031</b>	Abnormalities of internal FLASH memory	
<b>Clock abnormalities</b> [FAIL CLOCK]	Abnormalities of the internal clock	Make a setting of date/time. (P. 79) If a symptom like this is observed repeatedly, the built-in clock is seemingly malfunctioning. Thus, it must be replaced. Please contact RIKEN KEIKI.
<b>Cannot enter the user mode.</b>	A password to enter the user mode has been forgotten.	Please contact RIKEN KEIKI.



## 9-2. Abnormalities of readings

Symptoms	Causes	Actions
<b>The reading rises (drops) and it remains so.</b>	Drifting of sensor output	Perform zero adjustment (air calibration). (P. 40)
	Slow leak	A very small amount of the gas to be detected may be leaking (slow leak). Because ignoring it may cause dangers, take actions and measures which are taken at an occurrence of gas alarm.
	Environmental changes	Perform zero adjustment (air calibration). (P. 40) In particular, the galvanic cell type is affected by the air pressure.
<b>A gas alarm is triggered despite of no gas leak and no other abnormalities at the detection point.</b>	Disturbance by noise	Turn off the power once and then turn it on again (restart). If a symptom like this is observed frequently, take appropriate measures to eliminate the noise.
<b>Slow response</b>	Clogged dust filter	Replace the dust filter. (P. 100)
	Bended or clogged taper nozzle	Fix the defective parts.
	Condensation is formed inside the gas monitor.	Fix the defective parts by providing dry air, etc.
	Deteriorated sensor sensitivity	Replace the sensor with new one. (P. 102)
<b>Calibration impossible</b>	Improper calibration gas concentration	Use the proper calibration gas.
	Deteriorated sensor sensitivity	Replace the sensor with new one. (P. 102)
<b>VOC concentration rises despite of no abnormalities like gas leak at the detection point after zero calibration.</b>	Deteriorated electrode pellet	Replace the electrode pellet with new one. (P. 90)
<b>VOC sensor sensitivity has been deteriorated significantly.</b>	The PID lamp is contaminated.	Clean the PID lamp. (P. 103)
	Deteriorated PID lamp	Replace the PID lamp with new one. (P. 103)
<b>The concentration display area of the VOC sensor shows "----", the lamp flashes and the buzzer sounds.</b>	Presence of high concentrations of negative interfering gases (such as CH <sub>4</sub> )	Supply fresh air. When the gas is no longer affected, it will automatically resume measurement in about 10 seconds.
	The PID lamp is contaminated.	Supply fresh air. If the sensor does not recover even after supplying fresh air, restart the unit. If "SENSOR FAIL" is displayed after rebooting, the sensor may have deteriorated. Clean the PID lamp (P. 103). If the problem still persists, replace the PID lamp with new one (P. 103) or replace the electrode pellet with new one (P. 90).
	Deteriorated PID lamp	
	Deteriorated electrode pellet	

## 10

# Product Specifications

## 10-1. List of specifications

### <Common Specifications>

<b>Concentration display</b>	Digital LCD (full-dot display, 160 x 128 dots)
<b>Detection method</b>	Pump suction type
<b>Flow rate</b>	0.45 L/min or more (Open flow rate)
<b>Displays</b>	Clock display, battery level display, operating state display and flow check display
<b>Display language</b>	English, Japanese, French, Spanish Portuguese, Italian, German, Russian, Korean
<b>Buzzer sound volume</b>	95 dB (A) or higher (30 cm) (with protect cover)
<b>Gas alarm display</b>	Lamp blinking, continuous modulating buzzer sounding, gas concentration and alarm detail display blinking and vibration
<b>Gas alarm pattern</b>	Self-latching
<b>Fault alarm/self diagnosis</b>	System abnormalities, sensor abnormalities, battery voltage drop, calibration failure, and low flow rate
<b>Fault alarm display</b>	Lamp blinking, intermittent buzzer sounding, and detail display
<b>Fault alarm pattern</b>	Self-latching
<b>Panic alarm display</b>	Preliminary alarm: Lamp blinking, intermittent buzzer sounding Main alarm: Lamp blinking, continuous modulating buzzer sounding
<b>Panic alarm pattern</b>	Self-latching
<b>Man-down alarm display (*1)</b>	Preliminary alarm: Lamp blinking, intermittent buzzer sounding Main alarm: Lamp blinking, continuous modulating buzzer sounding
<b>Man-down alarm pattern (*1)</b>	Non latching (auto-reset)
<b>Transmission specification</b>	IrDA (for data logger)
<b>Power supply</b>	Standard: Dedicated lithium ion battery unit [BUL-6000] <sup>2</sup> Option: Dedicated dry battery unit <AA alkaline dry battery x 3> [BUD-6000]
<b>Continuous operating time</b>	BUL-6000: About 14 hours (25 °C, no alarm and no lighting) BUD-6000: About 8 hours (25 °C, no alarm and no lighting)
<b>Operating temperatures</b>	-20 - +50 °C (at a constant condition)
<b>Operating humidities</b>	Below 95 % RH (Non-condensing)
<b>Structure</b>	Drip-proof and dust-proof performances (compliant to IP67 level) (tubes excluded)
<b>Explosion-proof structure</b>	Intrinsically safe explosion-proof structure
<b>Explosion-proof class</b>	<p>ATEX/UKEX :</p> <ul style="list-style-type: none"> <li>II 1 G Ex ia IIB T4 Ga (with combustible gas sensor, BUL-6000)</li> <li>II 1 G Ex ia IIC T4 Ga (without combustible gas sensor, BUL-6000)</li> <li>II 1 G Ex ia IIB T4 Ga (with combustible gas sensor, BUD-6000 TOSHIBA)</li> <li>II 1 G Ex ia IIC T4 Ga (without combustible gas sensor, BUD-6000 TOSHIBA)</li> <li>II 1 G Ex ia IIB T3 Ga (with combustible gas sensor, BUD-6000DURACELL)</li> <li>II 1 G Ex ia IIC T3 Ga (without combustible gas sensor, BUD-6000DURACELL)</li> </ul> <p>IECEx :</p> <ul style="list-style-type: none"> <li>Ex ia IIB T4 Ga (with combustible gas sensor, BUL-6000)</li> <li>Ex ia IIC T4 Ga (without combustible gas sensor, BUL-6000)</li> <li>Ex ia IIB T4 Ga (with combustible gas sensor, BUD-6000 TOSHIBA)</li> </ul>

	Ex ia IIC T4 Ga (without combustible gas sensor, BUD-6000 TOSHIBA) Ex ia IIB T3 Ga (with combustible gas sensor, BUD-6000DURACELL) Ex ia IIC T3 Ga (without combustible gas sensor, BUD-6000DURACELL) Japan Ex : Ex ia IIC T4X
<b>External dimensions</b>	Approx. 70 (W) x 201 (H) x 54 (D) mm (projection portions excluded)
<b>Weight</b>	Approx. 500 g (When BUL-6000 is used)/Approx. 450 g (When BUD-6000 is used)

\*1 Normally the man-down alarm function is set to OFF and unavailable. To use this function, please contact RIKEN KEIKI.

\*2 JG (Japanese Government) type approval is only available for the rechargeable battery type (BUL).

**<Specifications of Each Sensor>**

<b>Gas to be detected</b>	<b>Combustible gas (HC/CH<sub>4</sub>)<sup>*1</sup> &lt;%LEL&gt;</b>	<b>Oxygen (O<sub>2</sub>)</b>	<b>Hydrogen sulfide (H<sub>2</sub>S)</b>	<b>Carbon monoxide (CO)</b>
<b>Detection principle</b>	New ceramic	Galvanic cell type	Electrochemical type	Electrochemical type
<b>Detection range &lt;Service range&gt;</b>	0 - 100 %LEL	0 - 25.0 % <to 40.0 vol%>	0 - 30.0 ppm <to 100.0 ppm>	0 - 150 ppm <to 500 ppm>
<b>Minimum resolution</b>	1 %LEL	0.1 vol%	0.5 ppm	1 ppm
<b>Alarm setpoint</b>	10 %LEL (AL1) 50 %LEL (AL2) 100 %LEL (OVER)	19.5 vol% (AL1) 23.5 vol% (AL2) 40.0 vol% (OVER)	5.0 ppm (AL1) 30.0 ppm (AL2) 10.0 ppm (TWA) 15.0 ppm (STEL) 100.0 ppm (OVER)	25 ppm (AL1) 50 ppm (AL2) 25 ppm (TWA) 200 ppm (STEL) 500.0 ppm (OVER)
<b>Gas to be detected</b>	<b>Volatile organic compound (VOC) &lt;ppb&gt;</b>	<b>Volatile organic compound (VOC) &lt;ppm&gt;</b>	<b>Sulfur dioxide (SO<sub>2</sub>)</b>	<b>Nitrogen dioxide (NO<sub>2</sub>)</b>
<b>Detection principle</b>	Photoionization type	Photoionization type	Electrochemical type	Electrochemical type
<b>Detection range</b>	0 - 40000 ppb	0 - 4000 ppm	0 - 99.90 ppm	0 - 20.00 ppm
<b>Minimum resolution</b>	1 ppb (0 - 4000 ppb) 10 ppb (4000 - 40000 ppb)	0.1 ppm (0 - 400.0 ppm) 1 ppm (400 - 4000 ppm)	0.05 ppm	0.05 ppm
<b>Alarm setpoint</b>	5000 ppb (AL1) 10000 ppb (AL2) 40000 ppb (OVER)	400.0 ppm (AL1) 1000 ppm (AL2) 4000 ppm (OVER)	2.00 ppm (AL1) 5.00 ppm (AL2) 2.00 ppm (TWA) 5.00 ppm (STEL) 99.90 ppm (OVER)	3.00 ppm (AL1) 6.00 ppm (AL2) 3.00 ppm (TWA) 20.00 ppm (OVER)
<b>Gas to be detected</b>	<b>Hydrogen cyanide (HCN)</b>	<b>Ammonia (NH<sub>3</sub>)</b>	<b>Chlorine (Cl<sub>2</sub>)</b>	<b>Phosphine (PH<sub>3</sub>)</b>
<b>Detection principle</b>	Electrochemical type	Electrochemical type	Electrochemical type	Electrochemical type
<b>Detection range &lt;Service range&gt;</b>	0 - 15.0 ppm	0 - 400.0 ppm	0 - 10.00 ppm	0 - 20.00ppm
<b>Minimum resolution</b>	0.1 ppm	0.5 ppm	0.05 ppm	0.01ppm
<b>Alarm setpoint</b>	5.0 ppm (AL1) 10.0 ppm (AL2) 4.7 ppm (STEL) 15.0 ppm (OVER)	25.0 ppm (AL1) 50.0 ppm (AL2) 25.0 ppm (TWA) 35.0 ppm (STEL) 400.0 ppm (OVER)	0.50 ppm (AL1) 1.00 ppm (AL2) 0.50 ppm (TWA) 1.00 ppm (STEL) 10.00 ppm (OVER)	0.30ppm (AL1) 1.00ppm(AL2) 0.30ppm(TWA) 1.00ppm(STEL) 20.00ppm(OVER)
<b>Gas to be detected</b>	<b>Carbon dioxide (CO<sub>2</sub>)</b>	<b>Carbon dioxide (CO<sub>2</sub>)</b>	<b>Combustible gas (HC) &lt;%LEL/vol%&gt;</b>	<b>Combustible gas (CH<sub>4</sub>) &lt;%LEL/vol%&gt;</b>
<b>Detection principle</b>	Non-dispersive infrared type	Non-dispersive infrared type	Non-dispersive infrared type	Non-dispersive infrared type
<b>Detection range</b>	0 - 10.00 vol%	0 - 10000 ppm	0 - 100 %LEL <to 30.0 vol% > <sup>(*2)</sup>	0 - 100 %LEL - 100 vol% <sup>(*2)</sup>
<b>Minimum resolution</b>	0.02 vol%	20 ppm	1 %LEL/0.5 vol%	1 %LEL/0.5 vol%
<b>Alarm setpoint</b>	0.50 vol% (AL1) 3.00 vol% (AL2) 0.50 vol% (TWA) 3.00 vol% (STEL) 10.00 vol% (OVER)	5000 ppm (AL1) 5000 ppm (TWA) 10000 ppm (OVER)	10 %LEL/— (AL1) 50 %LEL/— (AL2) 30 vol% (OVER)	10 %LEL/— (AL1) 50 %LEL/— (AL2) 100.0 vol% (OVER)

\*1 Please refer to the table of correction factors for readings to other gases. The factory default setting is either CH<sub>4</sub> or HC (specified in the order).

\*2 The display automatically switches to the vol% range when the concentration of a detected combustible gas exceeds 100 %LEL.

Gas to be detected	Volatile organic compound (VOC)	
Detection principle	Photoionization type (10.0eV)	
Measurement mode	Normal Mode	Benzene Select Mode
Detection range <Service range>	0 - 100 ppm	0 - 50 ppm
Minimum resolution	0.01 ppm (0 - 10 ppm) 0.1 ppm (10 - 100 ppm)	0.01 ppm (0 - 10 ppm) 0.1 ppm (10 - 50 ppm)
Alarm setpoint	5 ppm (AL1) 10 ppm (AL2) 100 ppm (OVER)	50 ppm (OVER)

## 10-2. List of accessories

<b>Standard accessories</b>	<ul style="list-style-type: none"> <li>• Lithium ion battery unit (BUL-6000) / Charger (1 pc) or</li> <li>• Dry battery unit (BUD-6000) / AA alkaline battery (3 pcs)</li> <li>• Protect cover (1 pc)</li> <li>• Belt clip (1 pc)</li> <li>• Taper nozzle (1 pc)</li> <li>• Hand strap (1 pc)</li> <li>• LCD protection film (1 pc)</li> <li>• Activated carbon filter (1 pc) CF-8350(Provided only for the specification targeting VOC for detection) or CF-8501(Provided only for the specification targeting VOC and CO<sub>2</sub> for detection)</li> <li>• CO<sub>2</sub> removal filter (CF-284) (1 pc) (Provided only for the specification targeting CO<sub>2</sub> for detection)</li> <li>• Operating manual</li> <li>• Product warranty</li> </ul>
<b>Optional items (sold separately)</b>	<ul style="list-style-type: none"> <li>• Lithium ion battery unit (BUL-6000)</li> <li>• Charger (1 pc)</li> <li>• Dry battery unit (BUD-6000)</li> <li>• AA alkaline battery (3 pcs)</li> <li>• Gas sampling probe (1pc)</li> <li>• Gas sampling hose (0.75 m) (1pc)</li> <li>• Gas sampling hose (5 m) (1pc)</li> <li>• Gas sampling hose (10 m) (1pc)</li> <li>• Gas sampling hose (20 m) (1pc)</li> <li>• Gas sampling hose (30 m) (1pc)</li> <li>• PID Pre-Filert Tube (1pc/10tubes)</li> <li>• Tube holder (1pc)</li> <li>• Various filters</li> <li>• Gas sampling bag</li> <li>• Lamp cleaning kit</li> <li>• Data logger management program</li> <li>• Setting program for the list of gases for reading VOC</li> </ul>



### CAUTION

- The gas sampling hose may absorb a small amount of several of the GX-6000's target gases, such as toxic gases, solvents, or VOCs. This absorption causes the target gas reading on the GX-6000 to be lower than the sampled environment's actual gas level.

## 11

# Appendix

## 11-1. Calibration history/various trend/event history functions

The gas monitor has history and trend functions. To use these functions, please contact RIKEN KEIKI.

### NOTE

- The data logger management program (optional) is required to use the history and trend functions. Please contact RIKEN KEIKI for more information.

Data logger provides five functions.

#### (1) Interval trend

Records the change of measured concentration from power-on to power-off.

Up to 3600 latest data are recorded.

After the number of recorded data reaches 3600, the oldest data will be overwritten by the latest data.

\* However, when the maximum recording time is exceeded, the oldest data will be deleted before reaching 3600.

The maximum recording time is specified as follows for each interval time.

Interval time	10-second	20-second	30-second	1-minute	3-minute	5-minute	10-minute
Maximum recording time	10 hours	20 hours	30 hours	60 hours	180 hours	300 hours	600 hours

\*The standard interval time is "5 minutes."

Interval time can be set by "Data Logger Management Program" (optional).

#### (2) Alarm trend

Starting immediately after the alarm is triggered, this function records the change of measured concentration for one hour, which is from 30 minutes before the alarm was triggered until 30 minutes after the alarm was triggered.

Alarm trend records the peak value of five-second time at a 5-second interval.

Last eight measurement data shall be recorded.

When the number of data exceeds eight, the oldest data will be overwritten by the latest data.

#### (3) Alarm event

Records the trigger of alarm as an event.

The event records the time of alarm trigger, target measurement gas and type of alarm event (AL1, AL2, OVER).

Up to 100 latest events are recorded.

After the number of recorded events reaches 100, the oldest data will be overwritten by the latest data.

**(4) Trouble event**

Records the trigger of fault alarm as an event.

The event records the time when the trouble was triggered, the target gas of measurement, and the type of fault event.

Up to 100 latest events are recorded.

After the number of recorded events reaches 100, the oldest data will be overwritten by the latest data.

**(5) Calibration history**

Records data when the calibration is performed.

The history records the calibration time, concentration values before and after the calibration, as well as the calibration error.

Up to 100 latest calibration data are recorded.

After the number of recorded data reaches 100, the oldest data will be overwritten by the latest data.

**NOTE**

- 
- The data logger function of this gas monitor is entirely based on the overwriting system (the oldest data is deleted and the latest data is recorded).
  - The recorded data can be read out by the "Data Logger Management Program" (optional). See the operating manual of "Data Logger Management Program" for more information.
-

## 11-2. Definition of terms

<b>ppb</b>	Gas concentration indicated in the unit of one-billionth of the volume
<b>ppm</b>	Gas concentration indicated in the unit of one-millionth of the volume
<b>vol%</b>	Gas concentration indicated in the unit of one-hundredth of the volume
<b>LEL</b>	The acronym of Lower Explosive Limit. LEL refers to the lowest concentration of a combustible gas in air capable of causing explosion when ignited.
<b>TWA (Time weighted average exposure limit)</b>	An abbreviation for "TLV-TWA: Threshold Limit Value Time Weighted Average." A time weighted average concentration of toxic substances which is considered no harm on almost all the workers' health by repeated exposure at regular work of eight hours a day or 40 hours a week.
<b>STEL (Short term exposure limit)</b>	An abbreviation for "TLV-STEL: Threshold Limit Value Short Term Exposure Limit." A concentration of toxic substances which does not have harmful effects on the workers' health by 15-minute continuous exposure provided that everyday exposure does not exceed TWA value.
<b>Self-latching</b>	One of alarm patterns. Once an alarm is triggered, this keeps the alarm activated until it is reset even when the alarm conditions are not met.
<b>Non latching (auto-reset)</b>	One of alarm patterns. When an alarm is triggered, this stops the alarm automatically when the alarm conditions are not met.



## 11-3. List of gases for reading VOC

Normally, a volatile organic compound (VOC) concentration is displayed as isobutylene; however, the reading can be converted to a pre-registered gas concentration. See 'VOC reading setting' (P. 63) for the setting. VOC<10.0eV>sensor can not detect gases which of response factor is described "-" in the following list.

Gas name	Formula	CAS No.	Response factor (10.6eV)	Response factor (10.0eV)
A				
Acetaldehyde	C <sub>2</sub> H <sub>4</sub> O	75-07-0	3.4	-
Acetamide	C <sub>2</sub> H <sub>5</sub> NO	60-35-5	2	-
Acetic acid	C <sub>2</sub> H <sub>4</sub> O <sub>2</sub>	64-19-7	36.2	-
Acetic anhydride	C <sub>4</sub> H <sub>6</sub> O <sub>3</sub>	108-24-7	4	-
Acetoin	C <sub>4</sub> H <sub>8</sub> O <sub>2</sub>	513-86-0	1	-
Acetone	C <sub>3</sub> H <sub>6</sub> O	67-64-1	0.7	1.20
Acetophenone	C <sub>8</sub> H <sub>8</sub> O	98-86-2	0.6	-
Acetyl bromide	C <sub>2</sub> H <sub>3</sub> BrO	506-96-7	3	-
Acetylglycine, N-	C <sub>4</sub> H <sub>7</sub> NO <sub>3</sub>	543-24-8	2	-
Acrolein	C <sub>3</sub> H <sub>4</sub> O	107-02-8	3.2	-
Acrylic Acid	C <sub>3</sub> H <sub>4</sub> O <sub>2</sub>	79-10-7	2.7	-
Alkanes, n-, C <sub>6</sub> +	C <sub>n</sub> H <sub>2n+2</sub>		1	-
Allyl acetoacetate	C <sub>7</sub> H <sub>10</sub> O <sub>3</sub>	1118-84-9	1.5	-
Allyl alcohol	C <sub>3</sub> H <sub>6</sub> O	107-18-6	2.1	4
Allyl bromide	C <sub>3</sub> H <sub>5</sub> Br	106-95-6	3	-
Allyl chloride	C <sub>3</sub> H <sub>5</sub> Cl	107-05-1	4.5	-
Allyl glycidyl ether	C <sub>6</sub> H <sub>10</sub> O <sub>2</sub>	106-92-3	0.8	-
Allyl propyl disulfide	C <sub>6</sub> H <sub>12</sub> S <sub>2</sub>	2179-59-1	0.4	-
Ammonia	NH <sub>3</sub>	7664-41-7	8.5	-
Amyl acetate	C <sub>7</sub> H <sub>14</sub> O <sub>2</sub>	628-63-7	1.8	9
Amyl alcohol	C <sub>5</sub> H <sub>12</sub> O	71-41-0	3.5	10
Amyl alcohol, tert-	C <sub>5</sub> H <sub>12</sub> O	75-85-4	1.5	2.8
Anethole	C <sub>10</sub> H <sub>12</sub> O	104-46-1	0.4	-
Aniline	C <sub>6</sub> H <sub>7</sub> N	62-53-3	0.48	0.8
Anisole	C <sub>7</sub> H <sub>8</sub> O	100-66-3	0.5	0.59
Anisyl aldehyde	C <sub>8</sub> H <sub>8</sub> O <sub>2</sub>	123-11-5	0.4	-
Arsine	AsH <sub>3</sub>	7784-42-1	2.5	-
Asphalt, petroleum fumes		8052-42-4	1	-
B				
Benzaldehyde	C <sub>7</sub> H <sub>6</sub> O	100-52-7	0.9	0.9

Gas name	Formula	CAS No.	Response factor (10.6eV)	Response factor (10.0eV)
Benzene	C <sub>6</sub> H <sub>6</sub>	71-43-2	0.46	0.54
Benzene thiol	C <sub>6</sub> H <sub>5</sub> SH	108-98-5	0.7	0.8
Benzoic acid	C <sub>7</sub> H <sub>6</sub> O <sub>2</sub>	65-85-0	0.7	-
Benzonitrile	C <sub>7</sub> H <sub>5</sub> N	100-47-0	0.7	0.8
Benzoquinone, o-	C <sub>6</sub> H <sub>4</sub> O <sub>2</sub>	583-63-1	1	-
Benzoquinone, p-	C <sub>6</sub> H <sub>4</sub> O <sub>2</sub>	106-51-4	1	-
Benzoyl bromide	C <sub>7</sub> H <sub>5</sub> BrO	618-32-6	2	-
Benzyl 2-phenylacetate	C <sub>15</sub> H <sub>14</sub> O <sub>2</sub>	102-16-9	0.5	-
Benzyl acetate	C <sub>9</sub> H <sub>10</sub> O <sub>2</sub>	140-11-4	0.6	-
Benzyl alcohol	C <sub>7</sub> H <sub>8</sub> O	100-51-6	1.3	1.6
Benzyl chloride	C <sub>7</sub> H <sub>7</sub> Cl	100-44-7	0.48	0.7
Benzyl formate	C <sub>8</sub> H <sub>8</sub> O <sub>2</sub>	104-57-4	0.8	-
Benzyl isobutyrate	C <sub>11</sub> H <sub>14</sub> O <sub>2</sub>	103-28-6	0.5	-
Benzyl nitrile	C <sub>8</sub> H <sub>7</sub> N	140-29-4	1	-
Benzyl propionate	C <sub>10</sub> H <sub>12</sub> O <sub>2</sub>	122-63-4	0.5	-
Benzylamine	C <sub>7</sub> H <sub>9</sub> N	100-46-9	0.6	-
Biphenyl	C <sub>12</sub> H <sub>10</sub>	92-52-4	0.4	0.6
Borneol	C <sub>10</sub> H <sub>18</sub> O	507-70-0	0.8	-
Bromine	Br <sub>2</sub>	7726-95-6	15	-
Bromo-2,2-dimethylpropane, 1-	C <sub>5</sub> H <sub>11</sub> Br	630-17-1	2	-
Bromo-2-chloroethane, 1-	C <sub>2</sub> H <sub>4</sub> BrCl	107-04-0	8	-
Bromo-2-methylpentane, 1-	C <sub>6</sub> H <sub>13</sub> Br	25346-33-2	2	-
Bromoacetone	C <sub>3</sub> H <sub>5</sub> BrO	598-31-2	1	-
Bromoacetylene	C <sub>2</sub> HBr	593-61-3	4	-
Bromobenzene	C <sub>6</sub> H <sub>5</sub> Br	108-86-1	0.3	0.32
Bromobutane, 1-	C <sub>4</sub> H <sub>9</sub> Br	109-65-9	1	14
Bromobutane, 2-	C <sub>4</sub> H <sub>9</sub> Br	78-76-2	1.5	1.6
Bromocyclohexane	C <sub>6</sub> H <sub>11</sub> Br	108-85-0	3	-
Bromoethane	C <sub>2</sub> H <sub>5</sub> Br	74-96-4	5	-
Bromoethanol, 2-	C <sub>2</sub> H <sub>5</sub> BrO	540-51-2	2	-
Bromoethyl methyl ether, 2-	C <sub>3</sub> H <sub>7</sub> BrO	6482-24-2	2.5	-
Bromoform	CHBr <sub>3</sub>	75-25-2	2.8	-
Bromopentane, 1-	C <sub>5</sub> H <sub>11</sub> Br	110-53-2	2	3.5
Bromopropane, 1-	C <sub>3</sub> H <sub>7</sub> Br	106-94-5	1.3	70

Gas name	Formula	CAS No.	Response factor (10.6eV)	Response factor (10.0eV)
Bromopyridine, 3-	C <sub>5</sub> H <sub>4</sub> BrN	626-55-1	2	-
Bromopyridine, 4-	C <sub>5</sub> H <sub>4</sub> BrN	1120-87-2	2	-
Bromotrimethylsilane	C <sub>3</sub> H <sub>9</sub> BrSi	2857-97-8	2	-
But-2-ynal	C <sub>4</sub> H <sub>4</sub> O	1119-19-3	3	-
But-3-ynal	C <sub>4</sub> H <sub>4</sub> O	52844-23-2	1.5	-
Butadiene diepoxide, 1,3-	C <sub>4</sub> H <sub>6</sub> O <sub>2</sub>	1464-53-5	4	-
Butadiene, 1,3-	C <sub>4</sub> H <sub>6</sub>	106-99-0	0.8	0.8
Butane, n-	C <sub>4</sub> H <sub>10</sub>	106-97-8	44	-
Butanedione, 2,3-	C <sub>4</sub> H <sub>6</sub> O <sub>2</sub>	431-03-8	0.4	0.87
Butanoic acid	C <sub>4</sub> H <sub>8</sub> O <sub>2</sub>	107-92-6	5	-
Butanol, 1-	C <sub>4</sub> H <sub>10</sub> O	71-36-3	4	25
Butanol, 2-	C <sub>4</sub> H <sub>10</sub> O	78-92-2	3.0	8
Buten-3-ol, 1-	C <sub>4</sub> H <sub>8</sub> O	598-32-3	1.2	3
Butene, 1-	C <sub>4</sub> H <sub>8</sub>	106-98-9	1.5	-
Butene, 2-	C <sub>4</sub> H <sub>8</sub>	107-01-7	1.3	-
Butene, cis-2-	C <sub>4</sub> H <sub>8</sub>	590-18-1	1.3	-
Butene, trans-2-	C <sub>4</sub> H <sub>8</sub>	624-64-6	1.3	-
Butenoic acid, 3-	C <sub>4</sub> H <sub>6</sub> O <sub>2</sub>	107-93-7	2	-
Butoxyethanol, 2-	C <sub>6</sub> H <sub>14</sub> O <sub>2</sub>	111-76-2	1.1	-
Butoxyethoxyethanol	C <sub>8</sub> H <sub>18</sub> O <sub>3</sub>	112-34-5	1.0	-
Butoxyethylacetate, 2-	C <sub>8</sub> H <sub>16</sub> O <sub>3</sub>	112-07-2	3	-
Butyl acetate	C <sub>6</sub> H <sub>12</sub> O <sub>2</sub>	123-86-4	2.4	12
Butyl acetate, sec-	C <sub>6</sub> H <sub>12</sub> O <sub>2</sub>	105-46-4	2.4	5.5
Butyl acetate, tert-	C <sub>6</sub> H <sub>12</sub> O <sub>2</sub>	540-88-5	2	1.65
Butyl acrylate	C <sub>7</sub> H <sub>12</sub> O <sub>2</sub>	141-32-2	1.5	-
Butyl butyrate	C <sub>8</sub> H <sub>16</sub> O <sub>2</sub>	109-21-7	1.8	-
Butyl chloroformate	C <sub>5</sub> H <sub>9</sub> ClO <sub>2</sub>	592-34-7	3.2	-
Butyl cyclohexan-1-ol, 4- tert-	C <sub>10</sub> H <sub>20</sub> O	98-52-2	1.4	-
Butyl cyclohexyl acetate, 2- tert-	C <sub>12</sub> H <sub>22</sub> O <sub>2</sub>	88-41-5	0.8	-
Butyl ether, n-	C <sub>8</sub> H <sub>18</sub> O	142-96-1	0.7	1.10
Butyl glycidyl ether	C <sub>7</sub> H <sub>14</sub> O <sub>2</sub>	2426-08-6	2	-
Butyl iodide	C <sub>4</sub> H <sub>9</sub> I	542-69-8	1	-
Butyl isocyanate	C <sub>5</sub> H <sub>9</sub> NO	111-36-4	2.5	-
Butyl lactate	C <sub>7</sub> H <sub>14</sub> O <sub>3</sub>	138-22-7	2.5	-

Gas name	Formula	CAS No.	Response factor (10.6eV)	Response factor (10.0eV)
Butyl mercaptan	C <sub>4</sub> H <sub>10</sub> S	109-79-5	0.5	-
Butyl mercaptan, tert-	C <sub>4</sub> H <sub>10</sub> S	75-66-1	0.4	-
Butyl methacrylate	C <sub>8</sub> H <sub>14</sub> O <sub>2</sub>	97-88-1	1	-
Butyl propionate, n-	C <sub>7</sub> H <sub>14</sub> O <sub>2</sub>	590-01-2	1.8	4
Butylamine, n-	C <sub>4</sub> H <sub>11</sub> N	109-73-9	1	-
Butylamine, sec-	C <sub>4</sub> H <sub>11</sub> N	513-49-5	0.9	-
Butylamine, tert-	C <sub>4</sub> H <sub>11</sub> N	75-64-9	0.9	1.5
Butylbenzene	C <sub>10</sub> H <sub>14</sub>	104-51-8	0.5	0.45
Butylbenzene, sec-	C <sub>10</sub> H <sub>14</sub>	135-98-8	0.4	0.4
Butylbenzene, tert-	C <sub>10</sub> H <sub>14</sub>	98-06-6	0.4	0.4
Butylene carbonate, 1,2-	C <sub>5</sub> H <sub>8</sub> O <sub>3</sub>	4437-85-8	2	-
Butylphenol, o-sec-	C <sub>10</sub> H <sub>14</sub> O	89-72-5	0.9	-
Butyn-1-ol, 2-	C <sub>4</sub> H <sub>6</sub> O	764-01-2	1.5	-
Butyn-2-one	C <sub>4</sub> H <sub>4</sub> O	1423-60-5	3	-
Butyraldehyde	C <sub>4</sub> H <sub>8</sub> O	123-72-8	1.6	1.9
Butyrolactone, gamma-	C <sub>4</sub> H <sub>6</sub> O <sub>2</sub>	96-48-0	15	-
Butyryl chloride	C <sub>4</sub> H <sub>7</sub> ClO	141-75-3	3	-
<b>C</b>				
Camphene	C <sub>10</sub> H <sub>16</sub>	565-00-4	0.5	0.4
Camphor	C <sub>10</sub> H <sub>16</sub> O	76-22-2	0.4	-
Carbon disulfide	CS <sub>2</sub>	75-15-0	1.4	1.3
Carbon suboxide	C <sub>3</sub> O <sub>2</sub>	504-64-3	10	-
Carbon tetrabromide	CBr <sub>4</sub>	558-13-4	3	-
Carene	C <sub>10</sub> H <sub>16</sub>	13466-78-9	0.5	-
Carvacrol	C <sub>10</sub> H <sub>14</sub> O	499-75-2	0.8	-
Carvone, R-	C <sub>10</sub> H <sub>14</sub> O	6485-40-1	1	1.5
Caryophyllene	C <sub>15</sub> H <sub>24</sub>	13877-93-5	0.4	-
Chloramine	ClH <sub>2</sub> N	10599-90-3	2	-
Chloro-1,1-difluoroethene, 2-	C <sub>2</sub> HClF <sub>2</sub>	359-10-4	1.5	-
Chloro-2-propanone, 1-	C <sub>3</sub> H <sub>5</sub> ClO	78-95-5	1	-
Chloroacetaldehyde	C <sub>2</sub> H <sub>3</sub> ClO	107-20-0	3	-
Chlorobenzene	C <sub>6</sub> H <sub>5</sub> Cl	108-90-7	0.36	0.5
Chlorobutane, 1-	C <sub>4</sub> H <sub>9</sub> Cl	109-69-3	10	-
Chlorobutane, 2-	C <sub>4</sub> H <sub>9</sub> Cl	78-86-4	8	-
Chlorocyclohexane	C <sub>6</sub> H <sub>11</sub> Cl	542-18-7	4	20

Gas name	Formula	CAS No.	Response factor (10.6eV)	Response factor (10.0eV)
Chloroethyl methyl ether, 2-	C <sub>3</sub> H <sub>7</sub> ClO	627-42-9	2.6	-
Chloromethoxyethane	C <sub>3</sub> H <sub>7</sub> ClO	3188-13-4	4	-
Chloroprene	C <sub>4</sub> H <sub>5</sub> Cl	126-99-8	1.3	-
Chloropyridine, 2-	C <sub>5</sub> H <sub>4</sub> CIN	109-09-1	1	-
Chlorostyrene, o-	C <sub>8</sub> H <sub>7</sub> Cl	2039-87-4	0.4	-
Chlorotoluene, m-	C <sub>7</sub> H <sub>7</sub> Cl	108-41-8	0.5	-
Chlorotoluene, o-	C <sub>7</sub> H <sub>7</sub> Cl	95-49-8	0.5	-
Chlorotoluene, p-	C <sub>7</sub> H <sub>7</sub> Cl	106-43-4	0.39	0.3
Chlorotrifluoroethylene	C <sub>2</sub> ClF <sub>3</sub>	79-38-9	1	-
Cinnamic aldehyde	C <sub>9</sub> H <sub>8</sub> O	104-55-2	0.4	-
Cinnamyl acetate	C <sub>11</sub> H <sub>12</sub> O <sub>2</sub>	21040-45-9	0.4	-
Cinnamyl alcohol	C <sub>9</sub> H <sub>10</sub> O	104-54-1	0.4	-
Citral	C <sub>10</sub> H <sub>16</sub> O	5392-40-5	1	3.4
Citronellal	C <sub>10</sub> H <sub>18</sub> O	106-23-0	0.9	-
Citronellol	C <sub>10</sub> H <sub>20</sub> O	26489-01-0	1	-
Citronellol acetate	C <sub>12</sub> H <sub>22</sub> O <sub>2</sub>	150-84-5	1.5	-
Citronellol formate	C <sub>11</sub> H <sub>20</sub> O <sub>2</sub>	105-85-1	1.5	-
Citronellyl isobutyrate	C <sub>14</sub> H <sub>26</sub> O <sub>2</sub>	97-89-2	0.9	-
Coumarin	C <sub>9</sub> H <sub>6</sub> O <sub>2</sub>	91-64-5	0.4	-
Creosote		8021-39-4	1.0	-
Cresol, m-	C <sub>7</sub> H <sub>8</sub> O	108-39-4	2.2	1.5
Cresol, o-	C <sub>7</sub> H <sub>8</sub> O	95-48-7	1.1	1.5
Cresol, p-	C <sub>7</sub> H <sub>8</sub> O	106-44-5	1.1	1.5
Cresyl acetate, p-	C <sub>9</sub> H <sub>10</sub> O <sub>2</sub>	140-39-6	1	-
Cresyl ethyl ether, p-	C <sub>9</sub> H <sub>12</sub> O	622-60-6	0.8	-
Cresyl methyl ether	C <sub>8</sub> H <sub>10</sub> O	104-93-8	0.8	-
Crotonaldehyde	C <sub>4</sub> H <sub>6</sub> O	4170-30-3	1	-
Crotonyl alcohol	C <sub>4</sub> H <sub>8</sub> O	6117-91-5	0.8	-
Cumene	C <sub>9</sub> H <sub>12</sub>	98-82-8	0.32	-
Cycloalkanes			1.5	-
Cyclobutanone	C <sub>4</sub> H <sub>6</sub> O	1191-95-3	1.2	-
Cyclobutene	C <sub>4</sub> H <sub>6</sub>	822-35-5	3	-
Cycloheptane	C <sub>7</sub> H <sub>14</sub>	291-64-5	1.1	-
Cyclohex-2-enedione, 1,4-	C <sub>6</sub> H <sub>6</sub> O <sub>2</sub>	4505-38-8	1	-
Cyclohexane	C <sub>6</sub> H <sub>12</sub>	110-82-7	1.2	3.3

Gas name	Formula	CAS No.	Response factor (10.6eV)	Response factor (10.0eV)
Cyclohexanethiol	C <sub>6</sub> H <sub>12</sub> S	1569-69-3	0.5	-
Cyclohexanol	C <sub>6</sub> H <sub>12</sub> O	108-93-0	2.9	2.7
Cyclohexanone	C <sub>6</sub> H <sub>10</sub> O	108-94-1	1.1	1.20
Cyclohexene	C <sub>6</sub> H <sub>10</sub>	110-83-8	0.8	1.4
Cyclohexyl acetate	C <sub>8</sub> H <sub>14</sub> O <sub>2</sub>	622-45-7	1.2	-
Cyclohexylamine	C <sub>6</sub> H <sub>13</sub> N	108-91-8	1	0.9
Cyclooctadiene	C <sub>8</sub> H <sub>12</sub>	29965-97-7	1	-
Cyclopentadiene	C <sub>5</sub> H <sub>6</sub>	542-92-7	0.8	-
Cyclopentane	C <sub>5</sub> H <sub>10</sub>	287-92-3	12.0	-
Cyclopentanone	C <sub>5</sub> H <sub>8</sub> O	120-92-3	0.7	1.0
Cyclopentene	C <sub>5</sub> H <sub>8</sub>	142-29-0	1.5	140
Cyclopentene-1,3-dione, 4-	C <sub>5</sub> H <sub>4</sub> O <sub>2</sub>	930-60-9	1	-
Cyclopropylamine	C <sub>3</sub> H <sub>7</sub> N	765-30-0	0.8	1.7
Cymene, p-	C <sub>10</sub> H <sub>14</sub>	99-87-6	0.35	-
<b>D</b>				
Decahydronaphthalene	C <sub>10</sub> H <sub>18</sub>	91-17-8	0.9	-
Decanal	C <sub>10</sub> H <sub>20</sub> O	112-31-2	0.9	-
Decane	C <sub>10</sub> H <sub>22</sub>	124-18-5	0.9	4.2
Decyne, 1-	C <sub>10</sub> H <sub>18</sub>	764-93-2	1.3	0.83
Diacetone alcohol	C <sub>6</sub> H <sub>12</sub> O <sub>2</sub>	123-42-2	0.8	0.84
Diazine, 1,2-	C <sub>4</sub> H <sub>4</sub> N <sub>2</sub>	289-80-5	3	-
Diazine, 1,3-	C <sub>4</sub> H <sub>4</sub> N <sub>2</sub>	289-95-2	3	-
Dibromoacetylene	C <sub>2</sub> Br <sub>2</sub>	624-61-3	1.5	-
Dibromochloromethane	CHBr <sub>2</sub> Cl	124-48-1	10	-
Dibromocyclohexane, 1,2-	C <sub>6</sub> H <sub>10</sub> Br <sub>2</sub>	5401-62-7	3	-
Dibromocyclopentane	C <sub>5</sub> H <sub>8</sub> Br <sub>2</sub>	33547-17-0	3	-
Dibromodichloromethane	CBr <sub>2</sub> Cl <sub>2</sub>	594-18-3	4	-
Dibromoethane, 1,2-	C <sub>2</sub> H <sub>4</sub> Br <sub>2</sub>	106-93-4	2	-
Dibromoethene, 1,1-	C <sub>2</sub> H <sub>2</sub> Br <sub>2</sub>	593-92-0	1.5	-
Dibromoethene, 1,2-	C <sub>2</sub> H <sub>2</sub> Br <sub>2</sub>	540-49-8	1.5	-
Dibromomethane	CH <sub>2</sub> Br <sub>2</sub>	74-95-3	1.2	-
Dichloro-1,2-difluoroethene, 1,2-	C <sub>2</sub> Cl <sub>2</sub> F <sub>2</sub>	598-88-9	2	-
Dichloro-1-propene, 2,3-	C <sub>3</sub> H <sub>4</sub> Cl <sub>2</sub>	78-88-6	1.4	-
Dichloro-2,2,-difluoroethene, 1,1-	C <sub>2</sub> Cl <sub>2</sub> F <sub>2</sub>	79-35-6	1	-
Dichloroacetylene	C <sub>2</sub> Cl <sub>2</sub>	7572-29-4	5	-

Gas name	Formula	CAS No.	Response factor (10.6eV)	Response factor (10.0eV)
Dichlorobenzene, o-	C <sub>6</sub> H <sub>4</sub> Cl <sub>2</sub>	95-50-1	0.5	0.5
Dichlorobenzene, p-	C <sub>6</sub> H <sub>4</sub> Cl <sub>2</sub>	106-46-7	0.5	0.5
Dichloroethene, 1,1-	C <sub>2</sub> H <sub>2</sub> Cl <sub>2</sub>	75-35-4	1	-
Dichloroethene, 1,2-	C <sub>2</sub> H <sub>2</sub> Cl <sub>2</sub>	540-59-0	0.36	0.29
Dichloroethene, cis-1,2-	C <sub>2</sub> H <sub>2</sub> Cl <sub>2</sub>	156-59-2	0.8	-
Dichloroethene, trans-1,2-	C <sub>2</sub> H <sub>2</sub> Cl <sub>2</sub>	156-60-5	0.36	-
Dichloromethane	CH <sub>2</sub> Cl <sub>2</sub>	75-09-2	39	-
Dichloromethylamine	CH <sub>3</sub> Cl <sub>2</sub> N	7651-91-4	2	-
Dicyclohexylamine	C <sub>12</sub> H <sub>23</sub> N	101-83-7	0.8	-
Dicyclopentadiene	C <sub>10</sub> H <sub>12</sub>	77-73-6	0.9	-
Diesel fuel		68334-30-5	0.8	-
Diethoxyethane, 1,1-	C <sub>6</sub> H <sub>14</sub> O <sub>2</sub>	105-57-7	0.9	1.0
Diethyl carbonate	C <sub>5</sub> H <sub>10</sub> O <sub>3</sub>	105-58-8	1.5	-
Diethyl ether	C <sub>4</sub> H <sub>10</sub> O	60-29-7	0.9	-
Diethyl maleate	C <sub>8</sub> H <sub>12</sub> O <sub>4</sub>	141-05-9	2	-
Diethyl malonate	C <sub>7</sub> H <sub>12</sub> O <sub>4</sub>	105-53-3	4.0	-
Diethyl phthalate	C <sub>12</sub> H <sub>14</sub> O <sub>4</sub>	84-66-2	1	-
Diethyl sulfate	C <sub>4</sub> H <sub>10</sub> SO <sub>4</sub>	64-67-5	3	-
Diethyl sulfide	C <sub>4</sub> H <sub>10</sub> S	352-93-2	0.6	0.5
Diethyl sulfone	C <sub>4</sub> H <sub>10</sub> O <sub>2</sub> S	597-35-3	2	-
Diethylacetylene	C <sub>6</sub> H <sub>10</sub>	928-49-4	2	-
Diethylaminopropylamine, 3-	C <sub>7</sub> H <sub>18</sub> N <sub>2</sub>	104-78-9	1.2	3
Diethylene glycol monoethyl ether	C <sub>6</sub> H <sub>14</sub> O <sub>3</sub>	111-90-0	0.6	-
Diethylenetriamine	C <sub>4</sub> H <sub>13</sub> N <sub>3</sub>	111-40-0	0.9	-
Diethylhydroxylamine	C <sub>4</sub> H <sub>11</sub> NO	3710-84-7	2	1.5
Diethylsilane	C <sub>4</sub> H <sub>12</sub> Si	542-91-6	2	-
Diglycidyl ether	C <sub>6</sub> H <sub>10</sub> O <sub>3</sub>	2238-07-5	3	-
Dihydroeugenol	C <sub>10</sub> H <sub>14</sub> O <sub>2</sub>	2785-87-7	0.4	-
Dihydrojasnone	C <sub>11</sub> H <sub>18</sub> O	1128-08-1	0.6	-
Dihydromyrcenol	C <sub>10</sub> H <sub>20</sub> O	18479-58-8	0.8	-
Dihydroxybenzene, 1,2-	C <sub>6</sub> H <sub>6</sub> O <sub>2</sub>	120-80-9	1	-
Dihydroxybenzene, 1,3-	C <sub>6</sub> H <sub>6</sub> O <sub>2</sub>	108-46-3	1	-
Diiodomethane	CH <sub>2</sub> I <sub>2</sub>	75-11-6	1.2	-
Diisobutyl ketone	C <sub>9</sub> H <sub>18</sub> O	108-83-8	0.8	0.7
Diisobutylene	C <sub>8</sub> H <sub>16</sub>	107-39-1	0.6	0.9

Gas name	Formula	CAS No.	Response factor (10.6eV)	Response factor (10.0eV)
Diisopropyl ether	C <sub>6</sub> H <sub>14</sub> O	108-20-3	0.7	0.95
Diisopropylbenzene	C <sub>12</sub> H <sub>18</sub>	25321-09-9	0.4	-
Diketene	C <sub>4</sub> H <sub>4</sub> O <sub>2</sub>	674-82-8	2.2	-
Dimethoxybenzene, 1,4-	C <sub>8</sub> H <sub>10</sub> O <sub>2</sub>	150-78-7	1.3	-
Dimethoxyethane, 1,2-	C <sub>4</sub> H <sub>10</sub> O <sub>2</sub>	110-71-4	1.2	1.2
Dimethoxymethane	C <sub>3</sub> H <sub>8</sub> O <sub>2</sub>	109-87-5	1.4	13
Dimethyl carbonate	C <sub>3</sub> H <sub>6</sub> O <sub>3</sub>	616-38-6	2.0	-
Dimethyl disulfide	C <sub>2</sub> H <sub>6</sub> S <sub>2</sub>	624-92-0	0.2	-
Dimethyl ether	C <sub>2</sub> H <sub>6</sub> O	115-10-6	1.3	-
Dimethyl phthalate	C <sub>10</sub> H <sub>10</sub> O <sub>4</sub>	131-11-3	1	-
Dimethyl sulfoxide	C <sub>2</sub> H <sub>6</sub> OS	67-68-5	1	32
Dimethylacetamide N,N-	C <sub>4</sub> H <sub>9</sub> NO	127-19-5	1.3	-
Dimethylacetylene	C <sub>4</sub> H <sub>6</sub>	503-17-3	1	-
Dimethylaminoethanol, 2-	C <sub>4</sub> H <sub>11</sub> NO	108-01-0	1.5	-
Dimethylaniline, NN-	C <sub>8</sub> H <sub>11</sub> N	121-69-7	0.6	0.5
Dimethylboron bromide	C <sub>2</sub> H <sub>6</sub> BBr	5158-50-9	4	-
Dimethylbutyl acetate	C <sub>8</sub> H <sub>16</sub> O <sub>2</sub>	108-84-9	1.6	-
Dimethylcycloheptane, 1,2-	C <sub>9</sub> H <sub>18</sub>	13151-50-3	1.3	-
Dimethylcyclohexane, 1,2-	C <sub>8</sub> H <sub>16</sub>	583-57-3	0.8	0.9
Dimethylcyclopentane	C <sub>7</sub> H <sub>14</sub>	1192-18-3	1.2	-
Dimethylethylamine, NN-	C <sub>4</sub> H <sub>11</sub> N	598-56-1	3	1.7
Dimethylformamide	C <sub>3</sub> H <sub>7</sub> NO	68-12-2	0.8	1.1
Dimethylhydrazine, 1,1-	C <sub>2</sub> H <sub>8</sub> N <sub>2</sub>	57-14-7	1	-
Dimethyloctan-1-ol, 3,7-	C <sub>10</sub> H <sub>22</sub> O	106-21-8	1.2	-
Dimethyloctan-3-ol, 3,7-	C <sub>10</sub> H <sub>22</sub> O	78-69-3	1.2	-
Dimethylpentane, 2,4-	C <sub>7</sub> H <sub>16</sub>	108-08-7	1.0	-
Dimethylsilane	C <sub>2</sub> H <sub>8</sub> Si	1111-74-6	2	-
Dimethylthiophosphoryl chloride	C <sub>2</sub> H <sub>6</sub> ClO <sub>2</sub> PS	2524-03-0	1	-
Di-n-butylamine	C <sub>8</sub> H <sub>19</sub> N	111-92-2	0.9	4
Di-n-propylamine	C <sub>6</sub> H <sub>15</sub> N	142-84-7	1	1.5
Dioxane, 1,4-	C <sub>4</sub> H <sub>8</sub> O <sub>2</sub>	123-91-1	1.5	1.7
Dioxolane	C <sub>3</sub> H <sub>6</sub> O <sub>2</sub>	646-06-0	1.8	4.5
Dipentene	C <sub>10</sub> H <sub>16</sub>	138-86-3	0.9	0.8
Diphenyl ether	C <sub>12</sub> H <sub>10</sub> O	101-84-8	0.8	1.7
Dipropyl ether	C <sub>6</sub> H <sub>14</sub> O	111-43-3	0.8	-



Gas name	Formula	CAS No.	Response factor (10.6eV)	Response factor (10.0eV)
Dipropylene glycol	C <sub>6</sub> H <sub>14</sub> O <sub>3</sub>	110-98-5	4	-
Disilane	Si <sub>2</sub> H <sub>6</sub>	1590-87-0	2	-
Disulfur dibromide	Br <sub>2</sub> S <sub>2</sub>	13172-31-1	1.5	-
Di-tert-butyl-p-cresol	C <sub>15</sub> H <sub>24</sub> O	128-37-0	0.3	-
Divinylbenzene	C <sub>10</sub> H <sub>10</sub>	1321-74-0	0.4	0.4
Divinylbenzene, 1,3-	C <sub>10</sub> H <sub>10</sub>	108-57-6	0.3	0.25
Dodecene	C <sub>12</sub> H <sub>26</sub>	112-40-3	0.8	-
<b>E</b>				
Epichlorohydrin	C <sub>3</sub> H <sub>5</sub> ClO	106-89-8	3.4	30
Epoxypropyl isopropyl ether, 2,3-	C <sub>6</sub> H <sub>12</sub> O <sub>2</sub>	4016-14-2	1.1	1.1
Etagole	C <sub>10</sub> H <sub>12</sub> O	140-67-0	0.7	-
Ethanol	C <sub>2</sub> H <sub>6</sub> O	64-17-5	8.7	-
Ethanolamine	C <sub>2</sub> H <sub>7</sub> NO	141-43-5	3	-
Ethoxy-2-methylpropane, 1-	C <sub>6</sub> H <sub>14</sub> O	627-02-1	0.8	-
Ethoxy-2-propanol, 1-	C <sub>5</sub> H <sub>12</sub> O <sub>2</sub>	1569-02-4	2	-
Ethoxy-butane, 2-	C <sub>6</sub> H <sub>14</sub> O	19316-73-5	0.8	-
Ethoxyethanol, 2-	C <sub>4</sub> H <sub>10</sub> O <sub>2</sub>	110-80-5	2	5
Ethoxyethyl acetate, 2-	C <sub>6</sub> H <sub>12</sub> O <sub>3</sub>	111-15-9	3	-
Ethyl 2,2,2-trifluoroethyl ether	C <sub>4</sub> H <sub>7</sub> F <sub>3</sub> O	461-24-5	5	-
Ethyl 2-methylbutyrate	C <sub>7</sub> H <sub>14</sub> O <sub>2</sub>	7452-79-1	2	1.8
Ethyl acetate	C <sub>4</sub> H <sub>8</sub> O <sub>2</sub>	141-78-6	3.6	40
Ethyl acetoacetate	C <sub>6</sub> H <sub>10</sub> O <sub>3</sub>	141-97-9	3	-
Ethyl acrylate	C <sub>5</sub> H <sub>8</sub> O <sub>2</sub>	140-88-5	2	15
Ethyl benzoate	C <sub>9</sub> H <sub>10</sub> O <sub>2</sub>	93-89-0	0.9	-
Ethyl butyrate	C <sub>6</sub> H <sub>12</sub> O <sub>2</sub>	105-54-4	1	3.3
Ethyl chloroformate	C <sub>3</sub> H <sub>5</sub> O <sub>2</sub> Cl	541-41-3	83	-
Ethyl cyanoacrylate	C <sub>6</sub> H <sub>7</sub> O <sub>2</sub> N	7085-85-0	1.5	-
Ethyl decanoate	C <sub>12</sub> H <sub>24</sub> O <sub>2</sub>	110-38-3	1.8	-
Ethyl formate	C <sub>3</sub> H <sub>6</sub> O <sub>2</sub>	109-94-4	29.8	-
Ethyl hexanoate	C <sub>8</sub> H <sub>16</sub> O <sub>2</sub>	123-66-0	2.6	3.3
Ethyl hexanol, 2-	C <sub>8</sub> H <sub>18</sub> O	104-76-7	1.5	-
Ethyl hexyl acrylate, 2-	C <sub>11</sub> H <sub>20</sub> O <sub>2</sub>	103-11-7	1	-
Ethyl iodide	C <sub>2</sub> H <sub>5</sub> I	75-03-6	1.2	0.30
Ethyl isopropyl ketone	C <sub>6</sub> H <sub>12</sub> O	565-69-5	0.8	-

Gas name	Formula	CAS No.	Response factor (10.6eV)	Response factor (10.0eV)
Ethyl lactate	C <sub>5</sub> H <sub>10</sub> O <sub>3</sub>	97-64-3	3	5
Ethyl mercaptan	C <sub>2</sub> H <sub>6</sub> S	75-08-1	0.56	0.55
Ethyl methacrylate	C <sub>6</sub> H <sub>10</sub> O <sub>2</sub>	97-63-2	1.5	1.6
Ethyl methyl carbonate	C <sub>4</sub> H <sub>8</sub> O <sub>3</sub>	623-53-0	1.5	-
Ethyl morpholine, 4-	C <sub>6</sub> H <sub>13</sub> NO	100-74-3	0.6	-
Ethyl octanoate	C <sub>10</sub> H <sub>20</sub> O <sub>2</sub>	106-32-1	2.3	-
Ethyl phenyl acetate	C <sub>10</sub> H <sub>12</sub> O <sub>2</sub>	101-97-3	1.2	-
Ethyl propanoate	C <sub>5</sub> H <sub>10</sub> O <sub>2</sub>	105-37-3	2	6
Ethyl tert-butyl ether	C <sub>6</sub> H <sub>14</sub> O	637-92-3	0.6	-
Ethyl-2-methyl benzene, 1-	C <sub>9</sub> H <sub>12</sub>	611-14-3	0.45	0.5
Ethyl-3-ethoxypropionate	C <sub>7</sub> H <sub>14</sub> O <sub>3</sub>	763-69-9	3	-
Ethylacetylene	C <sub>4</sub> H <sub>6</sub>	107-00-6	3	-
Ethylamine	C <sub>2</sub> H <sub>7</sub> N	75-04-7	1	-
Ethylbenzene	C <sub>8</sub> H <sub>10</sub>	100-41-4	0.5	0.6
Ethylcyclohexane	C <sub>8</sub> H <sub>16</sub>	1678-91-7	1	1.3
Ethylene	C <sub>2</sub> H <sub>4</sub>	74-85-1	8	-
Ethylene carbonate	C <sub>3</sub> H <sub>4</sub> O <sub>3</sub>	96-49-1	3	-
Ethylene glycol	C <sub>2</sub> H <sub>6</sub> O <sub>2</sub>	107-21-1	20	9
Ethylene glycol diacetate	C <sub>6</sub> H <sub>10</sub> O <sub>4</sub>	111-55-7	4	-
Ethylene glycol monopropyl ether	C <sub>5</sub> H <sub>12</sub> O <sub>2</sub>	2807-30-9	3	-
Ethylene oxide	C <sub>2</sub> H <sub>4</sub> O	75-21-8	15	-
Ethylenediamine	C <sub>2</sub> H <sub>8</sub> N <sub>2</sub>	107-15-3	0.8	10
Ethyleneimine	C <sub>2</sub> H <sub>5</sub> N	151-56-4	2	-
Ethylhexanal, 2-	C <sub>8</sub> H <sub>16</sub> O	123-05-7	1.5	-
Ethylhexanoic acid, 2-	C <sub>8</sub> H <sub>16</sub> O <sub>2</sub>	149-57-5	2.0	16
Ethylhexenal, 2-	C <sub>8</sub> H <sub>14</sub> O	645-62-5	1.3	-
Eucalyptol	C <sub>10</sub> H <sub>18</sub> O	470-82-6	0.6	-
Eugenol	C <sub>10</sub> H <sub>12</sub> O <sub>2</sub>	97-53-0	0.4	-
Eugenol methyl ether	C <sub>11</sub> H <sub>14</sub> O <sub>2</sub>	93-15-2	0.4	-
<b>F</b>				
Fenchol	C <sub>10</sub> H <sub>18</sub> O	1632-73-1	0.4	-
Ferrocene	C <sub>10</sub> H <sub>10</sub> Fe	102-54-5	0.8	-
Fluorobenzene	C <sub>6</sub> H <sub>5</sub> F	462-06-6	0.8	0.83
Fluorobenzoic acid, 4-	C <sub>7</sub> H <sub>5</sub> FO <sub>2</sub>	456-22-4	2	-
Formamide	CH <sub>3</sub> ON	75-12-7	2	-

Gas name	Formula	CAS No.	Response factor (10.6eV)	Response factor (10.0eV)
Furan	C <sub>4</sub> H <sub>4</sub> O	110-00-9	0.4	-
Furfural	C <sub>5</sub> H <sub>4</sub> O <sub>2</sub>	98-01-1	0.82	-
Furfuryl alcohol	C <sub>5</sub> H <sub>6</sub> O <sub>2</sub>	98-00-0	2	-
Furfuryl mercaptan	C <sub>5</sub> H <sub>6</sub> OS	98-02-2	0.5	-
<b>G</b>				
Gasoline		8006-61-9	0.8	1
Geranial	C <sub>10</sub> H <sub>16</sub> O	141-27-5	0.6	-
Geraniol	C <sub>10</sub> H <sub>18</sub> O	106-24-1	0.7	-
Geranyl acetate	C <sub>12</sub> H <sub>20</sub> O <sub>2</sub>	105-87-3	1.2	-
Germane	GeH <sub>4</sub>	7782-65-2	10	-
Glutaraldehyde	C <sub>5</sub> H <sub>8</sub> O <sub>2</sub>	111-30-8	0.9	-
Glycidyl methacrylate	C <sub>7</sub> H <sub>10</sub> O <sub>3</sub>	106-91-2	1.2	-
Glycolaldehyde	C <sub>2</sub> H <sub>4</sub> O <sub>2</sub>	141-46-8	5.0	-
Glyoxal	C <sub>2</sub> H <sub>2</sub> O <sub>2</sub>	107-22-2	1	-
Guaiacol	C <sub>7</sub> H <sub>8</sub> O <sub>2</sub>	90-05-1	0.8	-
<b>H</b>				
Heptan-2-one	C <sub>7</sub> H <sub>14</sub> O	110-43-0	0.7	0.97
Heptan-3-one	C <sub>7</sub> H <sub>14</sub> O	106-35-4	0.8	0.81
Heptane	C <sub>7</sub> H <sub>16</sub>	142-82-5	1.6	11
Heptanol	C <sub>7</sub> H <sub>16</sub> O	53535-33-4	1.7	-
Heptene, 1-	C <sub>7</sub> H <sub>14</sub>	592-76-7	0.9	1.1
Heptylcyclopentan-1-one, 2-	C <sub>12</sub> H <sub>22</sub> O	137-03-1	0.8	-
Heptyne, 1-	C <sub>7</sub> H <sub>12</sub>	628-71-7	2	-
Hex-1-en-3-ol	C <sub>6</sub> H <sub>12</sub> O	4798-44-1	0.9	-
Hexachlorodisilane	Cl <sub>6</sub> Si <sub>2</sub>	13465-77-5	8	-
Hexamethyldisilazane, 1,1,1,3,3,3-	C <sub>6</sub> H <sub>19</sub> NSi <sub>2</sub>	999-97-3	1	-
Hexamethyldisiloxane	C <sub>6</sub> H <sub>18</sub> OSi <sub>2</sub>	107-46-0	0.3	-
Hexamethylene diisocyanate	C <sub>8</sub> H <sub>12</sub> N <sub>2</sub> O <sub>2</sub>	822-06-0	1.5	-
Hexan-2-one	C <sub>6</sub> H <sub>12</sub> O	591-78-6	0.8	0.7
Hexane	C <sub>6</sub> H <sub>14</sub>	110-54-3	2.6	13
Hexanoic acid	C <sub>6</sub> H <sub>12</sub> O <sub>2</sub>	142-62-1	3	-
Hexanol	C <sub>6</sub> H <sub>14</sub> O	111-27-3	2	7
Hexene, 1-	C <sub>6</sub> H <sub>12</sub>	592-41-6	0.9	1.1
Hexenyl acetate, cis-3-	C <sub>8</sub> H <sub>14</sub> O <sub>2</sub>	3681-71-8	1.5	1.2
Hexenyl butyrate, cis-3-	C <sub>10</sub> H <sub>18</sub> O <sub>2</sub>	16491-36-4	1.5	-

Gas name	Formula	CAS No.	Response factor (10.6eV)	Response factor (10.0eV)
Hexylaldehyde	C <sub>6</sub> H <sub>12</sub> O	66-25-1	0.6	1.8
Hydrazine	H <sub>4</sub> N <sub>2</sub>	302-01-2	3	-
Hydrogen iodide	HI	10034-85-2	5	-
Hydrogen selenide	H <sub>2</sub> Se	7783-07-5	2	-
Hydrogen sulfide	H <sub>2</sub> S	7783-06-4	4	-
Hydrogen telluride	H <sub>2</sub> Te	7783-09-7	1.5	-
Hydroxybutanal, 3-	C <sub>4</sub> H <sub>8</sub> O <sub>2</sub>	107-89-1	2.0	-
Hydroxycitronellal	C <sub>10</sub> H <sub>20</sub> O <sub>2</sub>	107-75-5	1	-
Hydroxyethyl acrylate	C <sub>5</sub> H <sub>8</sub> O <sub>3</sub>	818-61-1	1.2	-
Hydroxylamine	H <sub>3</sub> NO	7803-49-8	2	-
Hydroxypropyl acrylate, 2-	C <sub>6</sub> H <sub>10</sub> O <sub>3</sub>	999-61-1	1.5	-
<b>I</b>				
Indene	C <sub>9</sub> H <sub>8</sub>	95-13-6	0.5	0.4
Indole	C <sub>8</sub> H <sub>7</sub> N	120-72-9	0.4	-
Iodine	I <sub>2</sub>	7553-56-2	0.2	0.1
Iodobenzene	C <sub>6</sub> H <sub>5</sub> I	591-50-4	0.2	-
Iodoethene	C <sub>2</sub> H <sub>3</sub> I	593-66-8	1.2	-
Iodoform	CHI <sub>3</sub>	75-47-8	1.5	-
Iodomethane	CH <sub>3</sub> I	74-88-4	0.4	-
Isoalkanes, C10-C13		68551-17-7	1	-
Isoamyl acetate	C <sub>7</sub> H <sub>14</sub> O <sub>2</sub>	123-92-2	1.6	6
Isoamyl salicylate	C <sub>12</sub> H <sub>16</sub> O <sub>3</sub>	87-20-7	1	-
Isoamylene	C <sub>5</sub> H <sub>10</sub>	513-35-9	1	0.86
Isobornyl acetate	C <sub>12</sub> H <sub>20</sub> O <sub>2</sub>	125-12-2	0.4	-
Isobutane	C <sub>4</sub> H <sub>10</sub>	75-28-5	8	-
Isobutanol	C <sub>4</sub> H <sub>10</sub> O	78-83-1	3.5	13
Isobutyl acetate	C <sub>6</sub> H <sub>12</sub> O <sub>2</sub>	110-19-0	2.3	10
Isobutyl acrylate	C <sub>7</sub> H <sub>12</sub> O <sub>2</sub>	106-63-8	1.3	5
Isobutylbenzene	C <sub>10</sub> H <sub>14</sub>	538-93-2	0.4	0.4
Isobutylene	C <sub>4</sub> H <sub>8</sub>	115-11-7	1	1
Isobutylene epoxide	C <sub>4</sub> H <sub>8</sub> O	558-30-5	3	-
Isobutyraldehyde	C <sub>4</sub> H <sub>8</sub> O	78-84-2	1.2	-
Isobutyric acid	C <sub>4</sub> H <sub>8</sub> O <sub>2</sub>	79-31-2	4	15
Isodecanol	C <sub>10</sub> H <sub>22</sub> O	25339-17-7	0.9	-
Isoeugenol	C <sub>10</sub> H <sub>12</sub> O <sub>2</sub>	97-54-1	0.4	-

Gas name	Formula	CAS No.	Response factor (10.6eV)	Response factor (10.0eV)
Isoheptane	C <sub>7</sub> H <sub>16</sub>	591-76-4	1.2	-
Isojasmone	C <sub>11</sub> H <sub>18</sub> O	95-41-0	0.7	-
Isomenthone	C <sub>10</sub> H <sub>18</sub> O	1196-31-2	0.6	-
Isononanal	C <sub>9</sub> H <sub>18</sub> O	5435-64-3	9.0	1.4
Isononanol	C <sub>9</sub> H <sub>20</sub> O	3452-97-9	1.5	-
Isooctane	C <sub>8</sub> H <sub>18</sub>	565-75-3	0.74	3.2
Isooctanol	C <sub>8</sub> H <sub>18</sub> O	26952-21-6	1.7	-
Isopentane	C <sub>5</sub> H <sub>12</sub>	78-78-4	4.0	-
Isopentene	C <sub>5</sub> H <sub>10</sub>	563-46-2	0.8	-
Isophorone	C <sub>9</sub> H <sub>14</sub> O	78-59-1	0.8	1.0
Isophorone diisocyanate	C <sub>12</sub> H <sub>18</sub> N <sub>2</sub> O <sub>2</sub>	4098-71-9	0.6	-
Isoprene	C <sub>5</sub> H <sub>8</sub>	78-79-5	0.8	-
Isopropanol	C <sub>3</sub> H <sub>8</sub> O	67-63-0	4.4	25
Isopropanolamine	C <sub>3</sub> H <sub>9</sub> NO	78-96-6	1.5	-
Isopropoxyethanol, 2-	C <sub>5</sub> H <sub>12</sub> O <sub>2</sub>	109-59-1	1.5	1.5
Isopropyl acetate	C <sub>5</sub> H <sub>10</sub> O <sub>2</sub>	108-21-4	2.2	8
Isopropyl chloroformate	C <sub>4</sub> H <sub>7</sub> O <sub>2</sub> Cl	108-23-6	1.6	-
Isopropyl mercaptan	C <sub>3</sub> H <sub>8</sub> S	75-33-2	0.56	-
Isopropyl nitrite	C <sub>3</sub> H <sub>7</sub> NO <sub>2</sub>	541-42-4	4	-
Isopropylamine	C <sub>3</sub> H <sub>9</sub> N	75-31-0	1.2	1
Isopropylaminoethanol, 2-	C <sub>5</sub> H <sub>13</sub> NO	109-56-8	2	-
Isopropylcyclohexane	C <sub>9</sub> H <sub>18</sub>	696-29-7	0.9	1.1
Isothiazole	C <sub>3</sub> H <sub>3</sub> NS	288-16-4	3	-
Isovaleraldehyde	C <sub>5</sub> H <sub>10</sub> O	590-86-3	1.3	1.5
Isovaleric acid	C <sub>5</sub> H <sub>10</sub> O <sub>2</sub>	503-74-2	3.0	25
Isoxazole	C <sub>3</sub> H <sub>3</sub> NO	288-14-2	6	-
<b>J</b>				
Jasmal	C <sub>11</sub> H <sub>22</sub> O <sub>3</sub>	1322-17-4	1.4	-
Jasmone, cis-	C <sub>11</sub> H <sub>16</sub> O	488-10-8	0.5	-
Jet Fuel JP-4			0.8	0.7
Jet Fuel JP-5			0.7	0.6
Jet Fuel JP-8			0.7	0.6
<b>K</b>				
Kerosene		8008-20-6	0.8	0.7
Ketene	C <sub>2</sub> H <sub>2</sub> O	463-51-4	3	-

Gas name	Formula	CAS No.	Response factor (10.6eV)	Response factor (10.0eV)
<b>L</b>				
Linalool oxide	C <sub>10</sub> H <sub>18</sub> O <sub>2</sub>	14049-11-7	0.6	-
Linalyl acetate	C <sub>12</sub> H <sub>20</sub> O <sub>2</sub>	115-95-7	0.9	-
<b>M</b>				
Maleic anhydride	C <sub>4</sub> H <sub>2</sub> O <sub>3</sub>	108-31-6	2	-
Menthol	C <sub>10</sub> H <sub>20</sub> O	1490-04-6	0.5	-
Menthone	C <sub>10</sub> H <sub>18</sub> O	89-80-5	0.4	-
Mercaptoacetic acid	C <sub>2</sub> H <sub>4</sub> O <sub>2</sub> S	68-11-1	1	-
Metalddehyde	C <sub>8</sub> H <sub>16</sub> O <sub>4</sub>	108-62-3	2.0	-
Methacrylamide	C <sub>4</sub> H <sub>7</sub> NO	79-39-0	2.0	-
Methacrylic acid	C <sub>4</sub> H <sub>6</sub> O <sub>2</sub>	79-41-4	2.3	-
Methacrylonitrile	C <sub>4</sub> H <sub>5</sub> N	126-98-7	5	-
Methanol	CH <sub>4</sub> O	67-56-1	200	-
Methoxy-1-butanol, 3-	C <sub>5</sub> H <sub>12</sub> O <sub>2</sub>	2517-43-3	3	-
Methoxy-1-propanol, 2-	C <sub>4</sub> H <sub>10</sub> O <sub>2</sub>	1589-47-5	2	-
Methoxy-2,2-dimethylpropane	C <sub>6</sub> H <sub>14</sub> O	1118-00-9	0.7	-
Methoxybutyl acetate, 3-	C <sub>7</sub> H <sub>14</sub> O <sub>3</sub>	4435-53-4	2	-
Methoxyethane	C <sub>3</sub> H <sub>8</sub> O	540-67-0	1.0	-
Methoxyethanol, 2-	C <sub>3</sub> H <sub>8</sub> O <sub>2</sub>	109-86-4	2.7	-
Methoxyethene	C <sub>3</sub> H <sub>6</sub> O	107-25-5	1	-
Methoxyethoxyethanol, 2-	C <sub>5</sub> H <sub>12</sub> O <sub>3</sub>	111-77-3	1.4	-
Methoxyethyl acetate	C <sub>5</sub> H <sub>10</sub> O <sub>3</sub>	110-49-6	2.7	-
Methoxyethyl ether, 2-	C <sub>6</sub> H <sub>14</sub> O <sub>3</sub>	111-96-6	0.8	-
Methoxymethylethoxy-2-propanol	C <sub>7</sub> H <sub>16</sub> O <sub>3</sub>	34590-94-8	1.3	-
Methoxypropan-2-ol, 1-	C <sub>4</sub> H <sub>10</sub> O <sub>2</sub>	107-98-2	2	2.7
Methoxypropane, 2-	C <sub>4</sub> H <sub>10</sub> O	598-53-8	0.9	-
Methoxypropyl acetate	C <sub>6</sub> H <sub>12</sub> O <sub>3</sub>	108-65-6	1.2	2.1
Methyl 2-methylpropanoate	C <sub>5</sub> H <sub>10</sub> O <sub>2</sub>	547-63-7	2	-
Methyl acetate	C <sub>3</sub> H <sub>6</sub> O <sub>2</sub>	79-20-9	5.2	-
Methyl acetoacetate	C <sub>5</sub> H <sub>8</sub> O <sub>3</sub>	105-45-3	3	-
Methyl acrylate	C <sub>4</sub> H <sub>6</sub> O <sub>2</sub>	96-33-3	3.4	80
Methyl anthranilate	C <sub>8</sub> H <sub>9</sub> NO <sub>2</sub>	134-20-3	0.4	-
Methyl benzoate	C <sub>8</sub> H <sub>8</sub> O <sub>2</sub>	93-58-3	1.2	-
Methyl bromide	CH <sub>3</sub> Br	74-83-9	1.9	-
Methyl dimethylacrylate	C <sub>6</sub> H <sub>10</sub> O <sub>2</sub>	924-50-5	2.5	-

Gas name	Formula	CAS No.	Response factor (10.6eV)	Response factor (10.0eV)
Methyl ethyl ketone	C <sub>4</sub> H <sub>8</sub> O	78-93-3	0.8	2
Methyl ethyl ketone peroxides	C <sub>8</sub> H <sub>18</sub> O <sub>6</sub>	1338-23-4	0.8	-
Methyl heptyne carbonate	C <sub>9</sub> H <sub>14</sub> O <sub>2</sub>	111-12-6	1.3	-
Methyl ionone	C <sub>14</sub> H <sub>22</sub> O	1335-46-2	0.4	-
Methyl isobutyl ketone	C <sub>6</sub> H <sub>12</sub> O	108-10-1	0.8	1.01
Methyl isocyanate	C <sub>2</sub> H <sub>3</sub> NO	624-83-9	5	-
Methyl isopropyl ketone	C <sub>5</sub> H <sub>10</sub> O	563-80-4	0.8	0.96
Methyl isothiocyanate	C <sub>2</sub> H <sub>3</sub> NS	556-61-6	0.6	-
Methyl mercaptan	CH <sub>4</sub> S	74-93-1	0.7	0.6
Methyl methacrylate	C <sub>5</sub> H <sub>8</sub> O <sub>2</sub>	80-62-6	1.6	2.1
Methyl phenyl acetate	C <sub>9</sub> H <sub>10</sub> O <sub>2</sub>	101-41-7	0.4	-
Methyl propargyl ether	C <sub>4</sub> H <sub>6</sub> O	627-41-8	2	-
Methyl propionate	C <sub>4</sub> H <sub>8</sub> O <sub>2</sub>	554-12-1	1.5	36
Methyl propynoate	C <sub>4</sub> H <sub>4</sub> O <sub>2</sub>	922-67-8	10	-
Methyl salicylate	C <sub>8</sub> H <sub>8</sub> O <sub>3</sub>	119-36-8	0.8	-
Methyl sulfide	C <sub>2</sub> H <sub>6</sub> S	75-18-3	0.5	0.7
Methyl tert-butyl ether	C <sub>5</sub> H <sub>12</sub> O	1634-04-4	0.8	1.02
Methyl thiocyanate	C <sub>2</sub> H <sub>3</sub> NS	556-64-9	2	-
Methyl thioglyconate	C <sub>3</sub> H <sub>6</sub> O <sub>2</sub> S	2365-48-2	1	-
Methyl undecanal, 2-	C <sub>12</sub> H <sub>24</sub> O	110-41-8	1.1	-
Methyl vinyl ketone	C <sub>4</sub> H <sub>6</sub> O	78-94-4	0.6	-
Methyl-1-butene, 3-	C <sub>5</sub> H <sub>10</sub>	563-45-1	0.8	-
Methyl-2-butanol, 3-	C <sub>5</sub> H <sub>12</sub> O	598-75-4	3.3	-
Methyl-2-hexenoic acid, trans-3-	C <sub>7</sub> H <sub>12</sub> O <sub>2</sub>	27960-21-0	1.5	-
Methyl-2-propen-1-ol, 2-	C <sub>4</sub> H <sub>8</sub> O	513-42-8	1.1	1.6
Methyl-2-pyrrolidinone, N-	C <sub>5</sub> H <sub>9</sub> NO	872-50-4	0.9	-
Methyl-5-hepten-2-one, 6-	C <sub>8</sub> H <sub>14</sub> O	110-93-0	0.8	0.76
Methylamine	CH <sub>5</sub> N	74-89-5	1.4	-
Methylbutan-1-ol, 3-	C <sub>5</sub> H <sub>12</sub> O	123-51-3	3	10
Methylbutanal, 2-	C <sub>5</sub> H <sub>10</sub> O	96-17-3	1.5	1.3
Methylbutanol	C <sub>5</sub> H <sub>12</sub> O	137-32-6	1.5	-
Methylbutyric acid, 2-	C <sub>5</sub> H <sub>10</sub> O <sub>2</sub>	116-53-0	3.5	20
Methylcyclohexane	C <sub>7</sub> H <sub>14</sub>	108-87-2	1.1	1
Methylcyclohexanol	C <sub>7</sub> H <sub>14</sub> O	25639-42-3	2.4	-
Methylcyclohexanol, 4-	C <sub>7</sub> H <sub>14</sub> O	589-91-3	2.4	-

Gas name	Formula	CAS No.	Response factor (10.6eV)	Response factor (10.0eV)
Methylcyclohexanone, 2-	C <sub>7</sub> H <sub>12</sub> O	583-60-8	1	-
Methylcyclopentane	C <sub>6</sub> H <sub>12</sub>	96-37-7	1.5	-
Methylenepentane, 3-	C <sub>6</sub> H <sub>12</sub>	760-21-4	0.8	-
Methylheptan-3-one, 5-	C <sub>8</sub> H <sub>16</sub> O	541-85-5	0.8	0.88
Methylhexan-2-one, 5-	C <sub>7</sub> H <sub>14</sub> O	110-12-3	0.8	0.91
Methylhydrazine	CH <sub>6</sub> N <sub>2</sub>	60-34-4	1.3	-
Methylpent-3-en-2-one, 4-	C <sub>6</sub> H <sub>10</sub> O	141-79-7	0.7	0.66
Methylpentan-2-ol, 4-	C <sub>6</sub> H <sub>14</sub> O	108-11-2	2.8	3
Methylpentane, 2-	C <sub>6</sub> H <sub>14</sub>	107-83-5	1.5	34
Methylpentane, 3-	C <sub>6</sub> H <sub>14</sub>	96-14-0	1.5	24
Methylpentane-2,4-diol, 2-	C <sub>6</sub> H <sub>14</sub> O <sub>2</sub>	107-41-5	4	-
Methylpropanoyl chloride, 2-	C <sub>4</sub> H <sub>7</sub> ClO	79-30-1	6	-
Methylpyrrole, N-	C <sub>5</sub> H <sub>7</sub> N	96-54-8	0.5	0.8
Methylstyrene	C <sub>9</sub> H <sub>10</sub>	25013-15-4	0.5	0.5
Methylthiopropional, 3-	C <sub>4</sub> H <sub>8</sub> OS	3268-49-3	2	-
Mineral oil		8042-47-5	0.8	0.7
Mineral spirits		64475-85-0	0.8	0.7
Monoisobutanolamine	C <sub>4</sub> H <sub>11</sub> NO	124-68-5	1.6	-
Morpholine	C <sub>4</sub> H <sub>9</sub> NO	110-91-8	2	2
Myrcene	C <sub>10</sub> H <sub>16</sub>	123-35-3	0.5	-
N				
Naphtha, hydrotrated heavy	C <sub>n</sub> H <sub>(2n+2)</sub>	64742-48-9	1.0	-
Naphthalene	C <sub>10</sub> H <sub>8</sub>	91-20-3	0.4	0.4
Naphthol methyl ether, 2-	C <sub>11</sub> H <sub>10</sub> O	93-04-9	0.5	-
Neopentane	C <sub>5</sub> H <sub>12</sub>	463-82-1	3.0	-
Neopentyl alcohol	C <sub>5</sub> H <sub>12</sub> O	75-84-3	2.0	-
Nitric oxide	NO	10102-43-9	8	-
Nitrobenzene	C <sub>6</sub> H <sub>5</sub> NO <sub>2</sub>	98-95-3	1.7	-
Nitrogen dioxide	NO <sub>2</sub>	10102-44-0	10	-
N-Methylolacrylamide	C <sub>4</sub> H <sub>7</sub> NO <sub>2</sub>	924-42-5	2.0	-
Nonane	C <sub>9</sub> H <sub>20</sub>	111-84-2	1.3	4.7
Nonanol (mixed isomers)	C <sub>9</sub> H <sub>20</sub> O	143-08-8	1.2	-
Nonene (mixed isomers)	C <sub>9</sub> H <sub>18</sub>	27215-95-8	0.8	-
Nonene, 1-	C <sub>9</sub> H <sub>18</sub>	124-11-8	0.55	-
Norbornadiene, 2,5-	C <sub>7</sub> H <sub>8</sub>	121-46-0	0.6	0.70



Gas name	Formula	CAS No.	Response factor (10.6eV)	Response factor (10.0eV)
<b>O</b>				
Octamethyltrisiloxane	C <sub>8</sub> H <sub>24</sub> O <sub>2</sub> Si <sub>3</sub>	107-51-7	0.3	-
Octane	C <sub>8</sub> H <sub>18</sub>	111-65-9	1.3	7
Octanol (mixed isomers)	C <sub>8</sub> H <sub>18</sub> O	111-87-5	1.5	-
Octene (mixed isomers)	C <sub>8</sub> H <sub>16</sub>	25377-83-7	0.9	-
Octene, 1-	C <sub>8</sub> H <sub>16</sub>	111-66-0	0.58	1.1
Oxalyl bromide	C <sub>2</sub> Br <sub>2</sub> O <sub>2</sub>	15219-34-8	5	-
Oxydiethanol, 2,2-	C <sub>4</sub> H <sub>10</sub> O <sub>3</sub>	111-46-6	2.0	-
<b>P</b>				
Paraffin wax, fume		8002-74-2	1	-
Paraffins, normal		64771-72-8	1	-
Paraldehyde	C <sub>6</sub> H <sub>12</sub> O <sub>3</sub>	123-63-7	2.0	4.8
Pentacarbonyl iron	FeC <sub>5</sub> O <sub>5</sub>	13463-40-6	1	-
Pentan-2-one	C <sub>5</sub> H <sub>10</sub> O	107-87-9	0.8	1.03
Pentan-3-one	C <sub>5</sub> H <sub>10</sub> O	96-22-0	0.8	0.75
Pentanal	C <sub>5</sub> H <sub>10</sub> O	110-62-3	1.2	1.75
Pentandione, 2,4-	C <sub>5</sub> H <sub>8</sub> O <sub>2</sub>	123-54-6	0.8	0.85
Pentane	C <sub>5</sub> H <sub>12</sub>	109-66-0	5	-
Pentanoic acid	C <sub>5</sub> H <sub>10</sub> O <sub>2</sub>	109-52-4	4	52
Pentanol, 2-	C <sub>5</sub> H <sub>12</sub> O	6032-29-7	1.5	16
Pentanol, 3-	C <sub>5</sub> H <sub>12</sub> O	584-02-1	1.5	3.5
Pentene, 1-	C <sub>5</sub> H <sub>10</sub>	109-67-1	1.3	1.00
Pentylcyclopentan-1-one, 2-	C <sub>10</sub> H <sub>18</sub> O	4819-67-4	1	-
Pentylcyclopentane	C <sub>10</sub> H <sub>20</sub>	3741-00-2	1.1	-
Pentyne, 1-	C <sub>5</sub> H <sub>8</sub>	627-19-0	3	-
Peracetic acid	C <sub>2</sub> H <sub>4</sub> O <sub>3</sub>	79-21-0	2	-
Perfluorobutadiene	C <sub>4</sub> F <sub>6</sub>	685-63-2	3	-
Perfluoro-tert-butylamine	C <sub>4</sub> H <sub>2</sub> F <sub>9</sub> N	2809-92-9	5	-
Petroleum ether		8032-32-4	0.9	-
Phellandrene	C <sub>10</sub> H <sub>16</sub>	99-83-2	0.8	-
Phenethyl methyl ether, 2-	C <sub>9</sub> H <sub>12</sub> O	3558-60-9	0.6	-
Phenol	C <sub>6</sub> H <sub>6</sub> O	108-95-2	1.2	1.1
Phenoxyethanol, 2-	C <sub>8</sub> H <sub>10</sub> O <sub>2</sub>	122-99-6	0.5	10
Phenyl chloroformate	C <sub>7</sub> H <sub>5</sub> ClO <sub>2</sub>	1885-14-9	1.1	-
Phenyl ethyl isobutyrate, 2-	C <sub>12</sub> H <sub>16</sub> O <sub>2</sub>	103-48-0	1.5	-

Gas name	Formula	CAS No.	Response factor (10.6eV)	Response factor (10.0eV)
Phenyl propene, 2-	C <sub>9</sub> H <sub>10</sub>	98-83-9	0.4	0.4
Phenyl-2,3-epoxypropyl ether	C <sub>9</sub> H <sub>10</sub> O <sub>2</sub>	122-60-1	0.8	-
Phenylacetaldehyde	C <sub>8</sub> H <sub>8</sub> O	122-78-1	0.7	-
Phenylacetic acid	C <sub>8</sub> H <sub>8</sub> O <sub>2</sub>	103-82-2	1	-
Phenylcyclohexane	C <sub>12</sub> H <sub>16</sub>	827-52-1	0.4	-
Phenylethyl acetate, 1-	C <sub>10</sub> H <sub>12</sub> O <sub>2</sub>	93-92-5	0.7	-
Phenylethyl alcohol, 2-	C <sub>8</sub> H <sub>10</sub> O	60-12-8	1.2	-
Phosphine	PH <sub>3</sub>	7803-51-2	2	-
Picoline, 3-	C <sub>6</sub> H <sub>7</sub> N	108-99-6	0.9	0.8
Pine oil		8002-09-3	1	-
Pinene, $\alpha$	C <sub>10</sub> H <sub>16</sub>	80-56-8	0.27	0.48
Pinene, $\beta$	C <sub>10</sub> H <sub>16</sub>	127-91-3	0.27	0.59
Piperazine	C <sub>4</sub> H <sub>10</sub> N <sub>2</sub>	110-85-0	0.8	-
Piperidine	C <sub>5</sub> H <sub>11</sub> N	110-89-4	0.9	0.8
Piperylene	C <sub>5</sub> H <sub>8</sub>	504-60-9	0.7	1.0
Prop-2-yn-1-ol	C <sub>3</sub> H <sub>4</sub> O	107-19-7	2.9	-
Propadiene	C <sub>3</sub> H <sub>4</sub>	463-49-0	1	-
Propan-1-ol	C <sub>3</sub> H <sub>8</sub> O	71-23-8	4.8	40
Propanamide	C <sub>3</sub> H <sub>7</sub> NO	79-05-0	2	-
Propane-1,2-diol	C <sub>3</sub> H <sub>8</sub> O <sub>2</sub>	57-55-6	3	-
Propanolamine	C <sub>3</sub> H <sub>9</sub> NO	156-87-6	1.5	-
Propargyl chloride	C <sub>3</sub> H <sub>3</sub> Cl	624-65-7	2	-
Propen-1-imine, 2-	C <sub>3</sub> H <sub>5</sub> N	73311-40-7	2	-
Propene	C <sub>3</sub> H <sub>6</sub>	115-07-1	1.4	2
Propiolic acid	C <sub>3</sub> H <sub>2</sub> O <sub>2</sub>	471-25-0	8	-
Propionaldehyde	C <sub>3</sub> H <sub>6</sub> O	123-38-6	1.7	-
Propionic acid	C <sub>3</sub> H <sub>6</sub> O <sub>2</sub>	79-09-4	8	-
Propoxy-2-propanol, 1-	C <sub>6</sub> H <sub>14</sub> O <sub>2</sub>	1569-01-3	1.1	1.6
Propyl acetate, n-	C <sub>5</sub> H <sub>10</sub> O <sub>2</sub>	109-60-4	2.5	17
Propyl benzene	C <sub>9</sub> H <sub>12</sub>	103-65-1	0.5	0.55
Propyl butanoate	C <sub>7</sub> H <sub>14</sub> O <sub>2</sub>	105-66-8	2.3	2.7
Propyl formate	C <sub>4</sub> H <sub>8</sub> O <sub>2</sub>	110-74-7	10	-
Propyl iodide	C <sub>3</sub> H <sub>7</sub> I	107-08-4	1	-
Propylamine, n-	C <sub>3</sub> H <sub>9</sub> N	107-10-8	1	-
Propylbenzene (all isomers)	C <sub>9</sub> H <sub>12</sub>	74296-31-4	0.45	-

Gas name	Formula	CAS No.	Response factor (10.6eV)	Response factor (10.0eV)
Propylene carbonate	C <sub>4</sub> H <sub>6</sub> O <sub>3</sub>	108-32-7	2	-
Propylene glycol ethyl ether acetate	C <sub>7</sub> H <sub>14</sub> O <sub>3</sub>	98516-30-4	1.2	-
Propylene oxide	C <sub>3</sub> H <sub>6</sub> O	75-56-9	2.7	-
Propyleneimine	C <sub>3</sub> H <sub>7</sub> N	75-55-8	1.3	-
Propyne	C <sub>3</sub> H <sub>4</sub>	74-99-7	4	-
Pyrazine	C <sub>4</sub> H <sub>4</sub> N <sub>2</sub>	290-37-9	3	-
Pyridine	C <sub>5</sub> H <sub>5</sub> N	110-86-1	0.8	0.87
Pyridinol, 4-	C <sub>5</sub> H <sub>5</sub> NO	626-64-2	3	-
Pyridylamine, 2-	C <sub>5</sub> H <sub>6</sub> N <sub>2</sub>	504-29-0	0.8	-
Pyrrole	C <sub>4</sub> H <sub>5</sub> N	109-97-7	0.6	-
Pyrrolidine	C <sub>4</sub> H <sub>9</sub> N	123-75-1	0.4	20
Pyruvaldehyde	C <sub>3</sub> H <sub>4</sub> O <sub>2</sub>	78-98-8	0.7	-
R				
Rose oxide, cis-	C <sub>10</sub> H <sub>18</sub> O	16409-43-1	0.8	-
S				
Sec-amyl acetate	C <sub>7</sub> H <sub>14</sub> O <sub>2</sub>	626-38-0	2	-
Stibine	SbH <sub>3</sub>	7803-52-3	1.5	-
Styrene	C <sub>8</sub> H <sub>8</sub>	100-42-5	0.35	0.52
T				
Terpineol, α	C <sub>10</sub> H <sub>18</sub> O	98-55-5	0.8	-
Terpinolene	C <sub>10</sub> H <sub>16</sub>	586-62-9	0.59	0.9
Terpinyl acetate, α	C <sub>12</sub> H <sub>20</sub> O <sub>2</sub>	80-26-2	1.2	-
Tert-amyl methyl ether	C <sub>6</sub> H <sub>14</sub> O	994-05-8	0.8	-
Tert-butanol	C <sub>4</sub> H <sub>10</sub> O	75-65-0	2.6	2.8
Tert-butyl bromide	C <sub>4</sub> H <sub>9</sub> Br	507-19-7	1.5	1.6
Tert-butyl formate	C <sub>5</sub> H <sub>10</sub> O <sub>2</sub>	762-75-4	8	-
Tetrabromoethane, 1,1,2,2-	C <sub>2</sub> H <sub>2</sub> Br <sub>4</sub>	79-27-6	2	-
Tetracarbonylnickel	NiC <sub>4</sub> O <sub>4</sub>	13463-39-3	1	-
Tetrachloroethylene	C <sub>2</sub> Cl <sub>4</sub>	127-18-4	0.44	0.33
Tetrachloropyridine, 2,3,5,6-	C <sub>5</sub> HCl <sub>4</sub> N	2402-79-1	1	-
Tetraethyl orthosilicate	C <sub>8</sub> H <sub>20</sub> O <sub>4</sub> Si	78-10-4	2	3
Tetrafluoroethylene	C <sub>2</sub> F <sub>4</sub>	116-14-3	15	-
Tetrahydrofuran	C <sub>4</sub> H <sub>8</sub> O	109-99-9	0.8	2.8
Tetrahydronaphthalene	C <sub>10</sub> H <sub>12</sub>	119-64-2	0.4	-
Tetrahydropyran	C <sub>5</sub> H <sub>10</sub> O	142-68-7	3	-

Gas name	Formula	CAS No.	Response factor (10.6eV)	Response factor (10.0eV)
Tetrahydrothiophene	C <sub>4</sub> H <sub>8</sub> S	110-01-0	0.6	0.5
Tetramethyl orthosilicate	C <sub>4</sub> H <sub>12</sub> O <sub>4</sub> Si	681-84-5	2.0	-
Tetramethyl succinonitrile	C <sub>8</sub> H <sub>12</sub> N <sub>2</sub>	3333-52-6	1	-
Tetramethylbenzene (all isomers)	C <sub>10</sub> H <sub>14</sub>	95-93-2	0.3	-
Tetramethylbutane, 2,2,3,3-	C <sub>8</sub> H <sub>18</sub>	594-82-1	1	-
Tetramethylgermane	C <sub>4</sub> H <sub>12</sub> Ge	865-52-1	2	-
Tetramethylguanidine, N,N,N',N'	C <sub>5</sub> H <sub>13</sub> N <sub>3</sub>	80-70-6	0.6	-
Tetramethylsilane	C <sub>4</sub> H <sub>12</sub> Si	75-76-3	2	-
Thioacetic acid	C <sub>2</sub> H <sub>4</sub> OS	507-09-5	2	-
Thiocarbonyl fluoride	CSF <sub>2</sub>	420-32-6	6	-
Thiocyanogen	C <sub>2</sub> S <sub>2</sub> N <sub>2</sub>	505-14-6	8	-
Thioformaldehyde trimer	C <sub>3</sub> H <sub>6</sub> S <sub>3</sub>	291-21-4	1.5	-
Thiophene	C <sub>4</sub> H <sub>4</sub> S	110-02-1	0.4	0.5
Thiophosgene	CSCl <sub>2</sub>	463-71-8	1	-
Thymol	C <sub>10</sub> H <sub>14</sub> O	89-83-8	0.7	-
Titanium-n-propoxide	C <sub>12</sub> H <sub>28</sub> O <sub>4</sub> Ti	3087-37-4	3	-
Toluene	C <sub>7</sub> H <sub>8</sub>	108-88-3	0.5	0.60
Toluene-2,4-diisocyanate	C <sub>9</sub> H <sub>6</sub> N <sub>2</sub> O <sub>2</sub>	584-84-9	1.6	-
Toluenesulfonyl chloride, p-	C <sub>7</sub> H <sub>7</sub> SO <sub>2</sub> Cl	98-59-9	3	-
Toluidine, o-	C <sub>7</sub> H <sub>9</sub> N	95-53-4	0.5	-
Tolylaldehyde, p-	C <sub>8</sub> H <sub>8</sub> O	104-87-0	0.8	-
Triazine, 1,3,5-	C <sub>3</sub> H <sub>3</sub> N <sub>3</sub>	290-87-9	6	-
Tributyl phosphate	C <sub>12</sub> H <sub>27</sub> O <sub>4</sub> P	126-73-8	5	-
Tributylamine	C <sub>12</sub> H <sub>27</sub> N	102-82-9	1.2	0.6
Trichlorobenzene, 1,2,4-	C <sub>6</sub> H <sub>3</sub> Cl <sub>3</sub>	120-82-1	0.6	0.5
Trichloroethylene	C <sub>2</sub> HCl <sub>3</sub>	79-01-6	0.7	0.8
Triethyl phosphate	C <sub>6</sub> H <sub>15</sub> O <sub>4</sub> P	78-40-0	3.5	-
Triethyl silane	C <sub>6</sub> H <sub>16</sub> Si	617-86-7	2	-
Triethylamine	C <sub>6</sub> H <sub>15</sub> N	121-44-8	0.9	1.1
Triethylbenzene	C <sub>12</sub> H <sub>18</sub>	25340-18-5	0.35	-
Triethylene aluminum	C <sub>6</sub> H <sub>15</sub> Al	97-93-8	1	-
Trifluoroethene	C <sub>2</sub> HF <sub>3</sub>	359-11-5	5	-
Trifluoroethyl methyl ether, 2,2,2-	C <sub>3</sub> H <sub>5</sub> F <sub>3</sub> O	460-43-5	10	-
Trifluoriodomethane	CF <sub>3</sub> I	2314-97-8	2	-
Trimethoxymethane	C <sub>4</sub> H <sub>10</sub> O <sub>3</sub>	149-73-5	1	10

Gas name	Formula	CAS No.	Response factor (10.6eV)	Response factor (10.0eV)
Trimethoxyvinylsilane	C <sub>5</sub> H <sub>12</sub> O <sub>3</sub> Si	2768-02-7	1.0	-
Trimethylamine	C <sub>3</sub> H <sub>9</sub> N	75-50-3	0.5	0.5
Trimethylbenzene mixtures	C <sub>9</sub> H <sub>12</sub>	25551-13-7	0.3	0.3
Trimethylbenzene, 1,3,5-	C <sub>9</sub> H <sub>12</sub>	108-67-8	0.4	0.5
Trimethylborate	C <sub>3</sub> H <sub>9</sub> BO <sub>3</sub>	121-43-7	1	-
Trimethylcyclohexane, 1,2,4-	C <sub>9</sub> H <sub>18</sub>	2234-75-5	1	-
Trimethylene oxide	C <sub>3</sub> H <sub>6</sub> O	503-30-0	1.5	-
Trimethylsilane	C <sub>3</sub> H <sub>10</sub> Si	993-07-7	1	-
Trioxane	C <sub>3</sub> H <sub>6</sub> O <sub>3</sub>	110-88-3	2	-
Turpentine	C <sub>10</sub> H <sub>16</sub>	9005-90-7	0.6	-
TVOC			1	1
U				
Undecane	C <sub>11</sub> H <sub>24</sub>	1120-21-4	0.9	3.1
V				
Vanillin	C <sub>8</sub> H <sub>8</sub> O <sub>3</sub>	121-33-5	1	-
Vinyl acetate	C <sub>4</sub> H <sub>6</sub> O <sub>2</sub>	108-05-4	1.1	1.77
Vinyl bromide	C <sub>2</sub> H <sub>3</sub> Br	593-60-2	1.5	0.9
Vinyl chloride	C <sub>2</sub> H <sub>3</sub> Cl	75-01-4	2.1	1.9
Vinyl ethyl ether	C <sub>4</sub> H <sub>8</sub> O	109-92-2	0.6	0.95
Vinyl fluoride	C <sub>2</sub> H <sub>3</sub> F	75-02-5	2	-
Vinyl-2-pyrrolidinone, 1-	C <sub>6</sub> H <sub>9</sub> NO	88-12-0	0.9	3.3
Vinylcyclohexene	C <sub>8</sub> H <sub>12</sub>	100-40-3	0.7	0.7
Vinylene carbonate	C <sub>3</sub> H <sub>2</sub> O <sub>3</sub>	872-36-6	1	5
Vinylidene difluoride	C <sub>2</sub> H <sub>2</sub> F <sub>2</sub>	75-38-7	5	-
Vinylsilane	C <sub>2</sub> H <sub>6</sub> Si	7291-09-0	1.5	-
X				
Xylene mixed isomers	C <sub>8</sub> H <sub>10</sub>	1330-20-7	0.40	0.59
Xylene, m-	C <sub>8</sub> H <sub>10</sub>	108-38-3	0.4	0.53
Xylene, o-	C <sub>8</sub> H <sub>10</sub>	95-47-6	0.6	0.6
Xylene, p-	C <sub>8</sub> H <sub>10</sub>	106-42-3	0.4	0.59
Xylidine, all	C <sub>8</sub> H <sub>11</sub> N	1300-73-8	0.7	0.6



# EU-Declaration of Conformity

Document No.: 320CE22096



We, RIKEN KEIKI Co., Ltd. 2-7-6, Azusawa, Itabashi-ku, Tokyo, 174-8744 Japan declare under our sole responsibility that the following product conforms to all the relevant provisions.

Product Name: Portable Multi-Gas Monitor  
Model: GX-6000

Council Directives		Applicable Standards
2014/30/EU	EMC Directive	EN 50270:2015
2014/34/EU	ATEX Directive	EN IEC 60079-0:2018 EN 60079-11:2012
2011/65/EU <sup>[1]</sup>	RoHS Directive	EN IEC 63000:2018

<sup>[1]</sup>Including substances added by Commission Delegated Directive (EU) 2015/863

EU-Type examination Certificate No.	Presafe 15 ATEX 6171X
Notified Body for ATEX	DNV Product Assurance AS (NB 2460) Veritasveien 1 1363 Høvik Norway
Auditing Organization for ATEX	DNV Product Assurance AS (NB 2460) Veritasveien 1 1363 Høvik Norway

The marking of the product shall include the following:

 II 1 G Ex ia IIC/IIB T4/T3 Ga

Alternative Marking:

- IIC:without combustible gas sensor
- IIB:with combustible gas sensor
- T4:battery type:BUL-6000 or BUD-6000 with LR6 (TOSHIBA)
- T3:battery type:BUD-6000 with MN1500 (Duracell)

Place: Tokyo, Japan

Date: Jun. 29, 2022

Takakura Toshiyuki  
General manager  
Quality Control Center



## EU-Declaration of Conformity

Document No.: 320CE22097



We, RIKEN KEIKI Co., Ltd. 2-7-6, Azusawa, Itabashi-ku, Tokyo, 174-8744 Japan declare under our sole responsibility that the following product conforms to all the relevant provisions.

Product Name: Battery Charger  
Model: BC-6000

Council Directives		Applicable Standards
2014/30/EU	EMC Directive	EN 50270:2015
2011/65/EU <sup>(1)</sup>	RoHS Directive	EN IEC 63000:2018

<sup>(1)</sup>Including substances added by Commission Delegated Directive (EU) 2015/863

Place: Tokyo, Japan

Date: Jun. 29, 2022

Takakura Toshiyuki  
General manager  
Quality Control Center



# UK-Declaration of Conformity

Document No.: 320UK22064



We, RIKEN KEIKI Co., Ltd. 2-7-6, Azusawa, Itabashi-ku, Tokyo, 174-8744, Japan declare under our sole responsibility that the following product conforms to all the relevant provisions.

Product Name: Portable Multi-Gas Monitor  
Model: GX-6000

Regulations	UK designated Standards
Electromagnetic Compatibility Regulations 2016 (S.I. 2016/1091)	BS EN 50270:2015
The Equipment and Protective Systems Intended for Use in Potentially Explosive Atmospheres Regulations 2016 (S.I. 2016/1107) (UKEX)	BS EN IEC 60079-0:2018 BS EN 60079-11:2012
The Restriction of the Use of Certain Hazardous Substances in Electrical and Electronic Equipment Regulations 2012 (S.I. 2012/3032)	BS EN IEC 63000:2018

UK-Type examination Certificate No.

DNV 22 UKEX 25912X

Approved Body for UKEX

DNV Business Assurance UK Ltd (AB8501)  
4th Floor Vivo Building, 30 Stamford Street,  
London SE1 9LQ, United Kingdom

Auditing Organization for UKEX

DNV Business Assurance UK Ltd (AB8501)  
4th Floor Vivo Building, 30 Stamford Street,  
London SE1 9LQ, United Kingdom

The marking of the product shall include the following:



II 1 G Ex ia IIC/IIB T4/T3 Ga -20°C≤Ta≤+50°C

Alternative Marking:

- IIC:without combustible gas sensor
- IIB:with combustible gas sensor
- T4:battery type:BUL-6000 or BUD-6000 with LR6 (TOSHIBA)
- T3:battery type:BUD-6000 with MN1500 (Duracell)

Place: Tokyo, Japan

Date: Nov. 18, 2022

Takakura Toshiyuki  
General manager  
Quality Control Center





# UK-Declaration of Conformity

Document No.: 320UK22065



We, RIKEN KEIKI Co., Ltd. 2-7-6, Azusawa, Itabashi-ku, Tokyo, 174-8744 Japan declare under our sole responsibility that the following product conforms to all the relevant provisions.

Product Name: Battery Charger  
Model: BC-6000

Regulations	UK designated Standards
Electromagnetic Compatibility Regulations 2016 (S.I. 2016/1091)	BS EN 50270:2015
The Restriction of the Use of Certain Hazardous Substances in Electrical and Electronic Equipment Regulations 2012 (S.I. 2012/3032)	BS EN IEC 63000:2018

Place: Tokyo, Japan

Date: May. 27, 2022

Takakura Toshiyuki  
General manager  
Quality Control Center