



PT0E-1677

**GX-3R/GX-3R Pro
Docking Station
SDM-3R
Operating Manual**

RIKEN KEIKI Co., Ltd.

2-7-6 Azusawa, Itabashi-ku, Tokyo, 174-8744, Japan

Phone : +81-3-3966-1113

Fax : +81-3-3558-9110

E-mail : intdept@rikenkeiki.co.jp

Web site : <https://www.rikenkeiki.co.jp/english/>

Contents

| | | |
|------|---|----|
| 1 | Product Overview | 3 |
| 1-1. | Introduction | 3 |
| 1-2. | Intended use | 3 |
| 1-3. | DANGER, WARNING, CAUTION, and NOTE | 4 |
| 1-4. | Method of confirmation for CE/UKCA marking type | 4 |
| 2 | Product Configuration | 5 |
| 2-1. | Main unit and accessories | 5 |
| | Main unit | 5 |
| | Accessories | 5 |
| 2-2. | Part names and functions | 6 |
| 3 | Usage Instructions | 8 |
| 3-1. | Usage note | 8 |
| 3-2. | Startup preparations | 8 |
| | 3-2-1. Required equipment/materials | 8 |
| | 3-2-2. Interconnection (optional) | 11 |
| | 3-2-3. Connecting the AC adapter | 13 |
| | 3-2-4. Mounting the gas monitor (sold separately) | 14 |
| | 3-2-5. Charging the gas monitor (sold separately) | 15 |
| | 3-2-6. Connecting the gas | 16 |
| | 3-2-7. Installing the PC Controller Program (optional) | 21 |
| 3-3. | Startup | 26 |
| | 3-3-1. Turning on the power | 26 |
| | 3-3-2. LED display list | 28 |
| 3-4. | Settings | 30 |
| | 3-4-1. Setting list | 32 |
| | 3-4-2. Cylinder settings | 34 |
| 3-5. | Operations using the product operation buttons | 36 |
| | 3-5-1. Bump test and calibration procedure | 36 |
| | 3-5-2. Copying test/calibration results to a USB flash drive (optional) | 40 |
| | 3-5-3. Downloading gas monitor (sold separately) logger data | 44 |
| 3-6. | Operating using the PC Controller Program (optional) | 45 |
| | 3-6-1. Bump test and calibration procedure | 45 |
| | 3-6-2. Creating a calibration certificate | 54 |
| 3-7. | Turning off the power | 56 |
| 4 | Storage and Disposal | 57 |
| 4-1. | Procedures for storage or when not in use for extended periods | 57 |
| 4-2. | Product disposal | 57 |
| 5 | Troubleshooting | 58 |
| 6 | Product Specifications | 60 |
| 6-1. | Specifications list | 60 |
| 6-2. | Accessory list | 60 |
| | Revision history | 61 |

Product Overview

1-1. Introduction

Thank you for your purchase of the SDM-3R Docking Station (“the product” hereinafter) for use with the GX-3R and GX-3R Pro Portable Gas Monitor. Please confirm that the model number of the product you purchased matches the model number of the product covered by this manual.

The product should be used only by fully-trained personnel.

The maintenance procedures described in this manual also should be performed only by appropriately-trained personnel. Any maintenance procedure not described in this manual must be performed by Riken Keiki or our certified service engineers. Please contact Riken Keiki.

This manual describes how to use the product and provides product specifications. Make sure you have read and fully understood the contents of this manual before using the product. This applies both to first-time users and those who have previously used the product. Keep this manual in a safe place for future reference.

The contents of this manual are subject to change without notice to allow product improvements. Any duplication or reproduction of this manual without permission is prohibited, whether in whole or in part.

In addition to this manual, manuals are provided for optional products. Refer to the following manuals along with this manual when using optional products:

- 1) GX-3R Portable Gas Monitor Operating Manual (PT0E-176)
- 2) GX-3R Pro Portable Gas Monitor Operating Manual (PT0E-177)

Regardless of the warranty period, Riken Keiki does not accept any liability for accidents or damage resulting from use of the product. Be sure to read the warranty policy set forth on the warranty.

1-2. Intended use

The product is a dedicated docking station designed for use with the GX-3R or GX-3R Pro Portable Gas Monitor (sold separately). It allows charging, bump testing, calibration, and alarm checking for the GX-3R or GX-3R Pro.



The product can be operated either using the buttons on the unit, or by connecting to a computer (PC) using the dedicated SW-SDM-3R(EX) PC Controller Program (optional).

The number of solenoid valves (one to three, specified at the time of purchase) and the number of gas types that can be connected simultaneously depend on the product specifications. Check the specifications before use to ensure correct use for the intended purpose.

Note that this document refers to the GX-3R and GX-3R Pro Portable Gas Monitor (sold separately) simply as “gas monitor (sold separately)”.

1-3. DANGER, WARNING, CAUTION, and NOTE

This manual uses the following headings to ensure safe and effective work:

| | |
|--|--|
|  DANGER | This indicates situations in which improper handling may result in fatal or serious injury to persons or serious damage to property. |
|  WARNING | This indicates situations in which improper handling may result in serious injury to persons or serious damage to property. |
|  CAUTION | This indicates situations in which improper handling may result in minor injury to persons or minor damage to property. |
| NOTE | This indicates handling tips. |

1-4. Method of confirmation for CE/UKCA marking type

The CE/UKCA marking is labeled on the detector in case of comply with CE/UKCA mark. Please confirm the instrument specification before using. Please refer Declaration of Conformity that is at the end of this manual if you have CE/UKCA marking type.

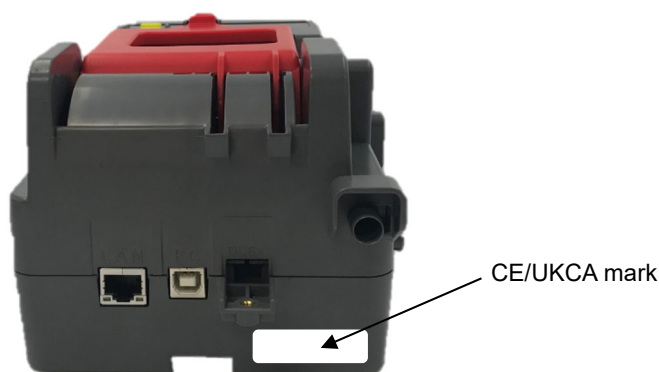

CE/UKCA mark label

Product Configuration

2-1. Main unit and accessories

Open the box and packaging and inspect the product and accessories.
If anything is missing, contact Riken Keiki.

Main unit

For detailed information on the names and functions of product parts and the LED display, see '2-2. Part names and functions' on page 6.



SDM-3R main unit

Accessories

- Cylindrical filter (×1)
- Tube (approx. 40 mm long, 5 mm - 7 mm diameter) (×1)
- AC adapter (×1)
- Cross recessed head screw (×1)

2-2. Part names and functions

This section describes the names and functions of the various parts of the main unit.

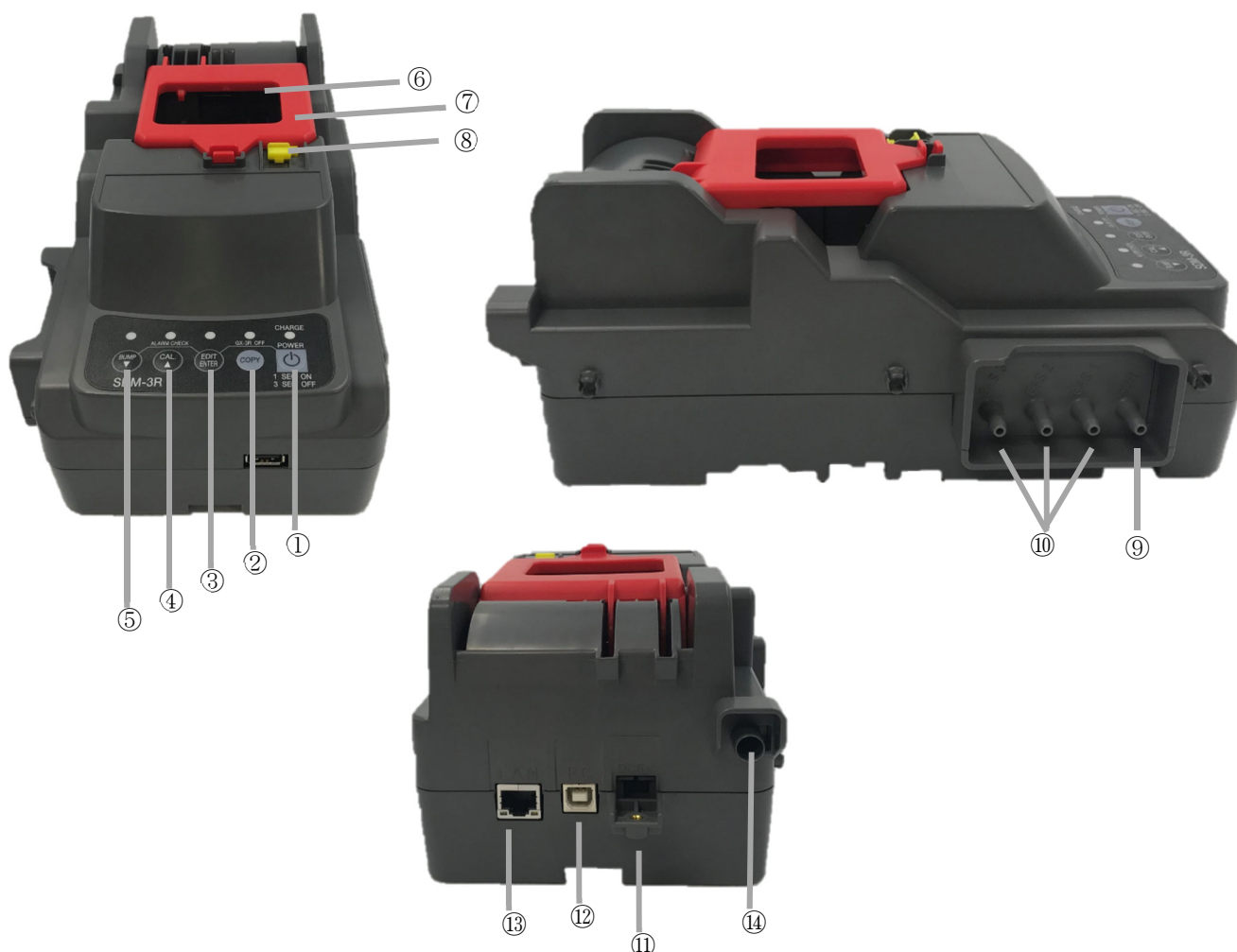

| No. | Name | Function |
|-----|-------------------|---|
| ① | POWER button | <ul style="list-style-type: none"> Turns the product power on and off. (Simultaneously pressing the EDIT/ENTER button turns off the gas monitor (sold separately).) |
| ② | COPY button | <ul style="list-style-type: none"> Copies bump test, calibration, and alarm check records to a USB flash drive (optional). (Simultaneously pressing the CAL/▲ button clears the memory in the main unit.) |
| ③ | EDIT/ENTER button | <ul style="list-style-type: none"> Displays various setting menus. (Simultaneously pressing the BUMP/▼ button starts the alarm check.) (Simultaneously pressing the POWER button turns off the gas monitor (sold separately).) |
| ④ | CAL/▲ button | <ul style="list-style-type: none"> Starts/cancels calibration. Moves the cursor up on the screen. (Simultaneously pressing the COPY button clears the memory in the main unit.) |
| ⑤ | BUMP/▼ button | <ul style="list-style-type: none"> Starts/cancels bump testing. Moves the cursor down on the screen. (Simultaneously pressing the EDIT/ENTER button starts/cancels the alarm check.) |
| ⑥ | Gas monitor dock | Position for mounting the gas monitor (sold separately) on the main unit |
| ⑦ | Gas monitor cover | Cover for securing the gas monitor (sold separately) in place on the main unit |

| No. | Name | Function |
|-----|-------------------------------|--|
| ⑧ | Lever | Used when switching between the GX-3R (sold separately) and GX-3R Pro (sold separately), as they are shaped differently. Raise to mount the GX-3R; push down to set the GX-3R Pro. |
| ⑨ | Air inlet | The inlet draws in air. |
| ⑩ | Gas inlets | The inlets draw in gas. Marked GAS 3/GAS 2/GAS 1 from left to right |
| ⑪ | Power jack | Insert the power supply AC adapter plug. |
| ⑫ | PC connection cable connector | Use a USB cable (Type-A male - Type-B male) (optional) to connect the product to a PC. |
| ⑬ | LAN cable connector | Use a LAN cable (optional) to connect the product to a network within the building. |
| ⑭ | Gas outlet | Expels aspirated gas. |

Usage Instructions

3-1. Usage note

The operating precautions apply to both first-time users and those who have previously used the product.
Ignoring these precautions may damage the product and result in inaccurate gas detection.

3-2. Startup preparations

NOTE

- The product is compatible with both the GX-3R and GX-3R Pro gas monitors (sold separately).

3-2-1. Required equipment/materials

The following equipment and materials are required in addition to the product.

- Gas monitor (GX-3R or GX-3R Pro)
- Gas for bump testing and calibration
- Gas sampling bag for exhaust gas (where necessary)
- Exhaust tube (where necessary)

<When using a gas cylinder>

- Demand flow valve
- Tube (no longer than 30 cm)

<When collecting gas in a gas sampling bag>

- Gas sampling bag

<Recommended bump test and calibration gas concentrations>

| Detection target gas | Sensor model | Gas | Gas concentration |
|-------------------------------------|---------------------------------|---|--|
| Combustible gas (HC) | NCR-6309 | Isobutane (i-C ₄ H ₁₀) | 50 %LEL (0.9 vol%) |
| Combustible gas (CH ₄) | NCR-6309 | Methane (CH ₄) | 50 %LEL (2.5 vol%) |
| Hydrogen sulfide (H ₂ S) | ESR-A1DP or ESR-A13i | Hydrogen sulfide (H ₂ S) | 25.0 ppm |
| Oxygen (O ₂) | ESR-X13P | Oxygen (O ₂) N ₂ diluted | 12.0 vol% |
| Carbon monoxide (CO) | ESR-A1DP, ESR-A1CP, or ESR-A13P | Carbon monoxide (CO) | 50 ppm |
| Carbon monoxide (CO) | ESR-A1CP | Hydrogen (H ₂) air diluted | 500 ppm |
| Sulfur dioxide (SO ₂) | ESR-A13D | Sulfur dioxide (SO ₂) N ₂ diluted | 8.00 ppm |
| Nitrogen dioxide (NO ₂) | ESR-A13D | Nitrogen dioxide (NO ₂) air diluted | 4.80 ppm |
| Hydrogen cyanide (HCN) | ESR-A13D | Hydrogen cyanide (HCN) | 8.0 ppm |
| | | Phosphine (PH ₃) (replacement gas) | 0.5 ppm (PH ₃ concentration × conversion factor = HCN concentration) |
| Phosphine (PH ₃) | ESR-A13D2 | Phosphine (PH ₃) | 0.50 ppm |
| Carbon dioxide (CO ₂) | IRR-0409 | Carbon dioxide (CO ₂) | 2.5 vol% |
| | | Nitrogen (N ₂) | 99.999 % |
| Carbon dioxide (CO ₂) | IRR-0433 | Carbon dioxide (CO ₂) | 5,000 ppm |
| | | Nitrogen (N ₂) | 99.999 % |



WARNING

Bump test and calibration gas

The bump test and calibration gas may be hazardous (combustible or toxic gas) or may cause oxygen deficiency. Handle the gas and related jigs and tools with due care.

Gas sampling bag

Use different gas sampling bags for each gas type and concentration to ensure accurate calibration.

Bump test and calibration location

- Do not perform bump tests or calibration in confined spaces.
- Do not perform bump tests or calibration in an atmosphere where silicone or organic solvents are present.
- Calibrate indoors at normal temperatures with no significant fluctuations (within ± 5 °C).

Carbon monoxide sensor (ESR-A1CP) calibration

- The carbon monoxide sensor with hydrogen interference correction function (ESR-A1CP) must be calibrated separately for carbon monoxide and hydrogen.
- The carbon monoxide and hydrogen used for calibration must each be a single gas. Calibration can be performed using a gas mixture, but it will result in poor sensitivity and inaccurate concentration readings.
- If hydrogen sensitivity is not calibrated, carbon monoxide readings may be slightly higher or lower than the actual concentrations when measured in environments where hydrogen is also present.
- Hydrogen must be calibrated within the temperature range from 10 °C to 30 °C.

Hydrogen cyanide sensor (ESR-A13D) calibration

- The bump test and calibration gas must be a standard gas consisting of hydrogen cyanide diluted with air or phosphine diluted with nitrogen or air. Calibration can be performed with a gas mixture. However, calibrations performed with a gas mixture will result in poor sensitivity and inaccurate concentration readings.
- When using a replacement gas (PH₃) for calibration, remove the interference gas removal filter (CF-A13D-2) before calibrating. For information on how to remove the filter, refer to the gas monitor (sold separately) operating manual.
- When calibrating using a replacement gas (PH₃), calculate calibration gas concentrations by multiplying the PH₃ concentration by the conversion factor (PH₃ concentration × conversion factor = HCN concentration) The conversion factor is indicated to the right of the sensor model printed on the side of the sensor. For information on how to remove the sensor, refer to the gas monitor (sold separately) operating manual.

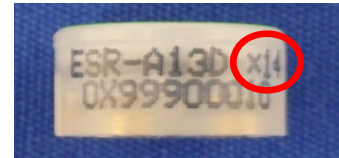

Typical conversion factor marking (14 in this example)



CAUTION

Gas discharge

- When feeding gas, it should either be discharged to a safe location with the gas outlet open to the atmosphere or collected using a gas sampling bag.
- When the product is used connected to other units, the gas discharge from each unit must be treated individually.

Carbon monoxide sensor (ESR-A1CP) calibration

- Hydrogen span adjustment may become impossible if the product is used or stored for extended periods in dry environments. If [FAIL SENSOR] is displayed during hydrogen span adjustment, allow the product to stand overnight in a sufficiently humid environment before repeating the span adjustment. If CO span adjustment is no longer possible, contact Riken Keiki to request sensor replacement.

3-2-2. Interconnection (optional)

The product can be used with up to ten units interconnected. Only the piping is connected; the units are not connected electrically. Do not connect more than ten units. Exceeding this number may result in inadequate flow rates due to piping resistance.

- 1 Confirm that the product is not connected to the power supply.**
- 2 Follow steps 3 to 5 below for all SDM-3R units except for the rightmost unit.**

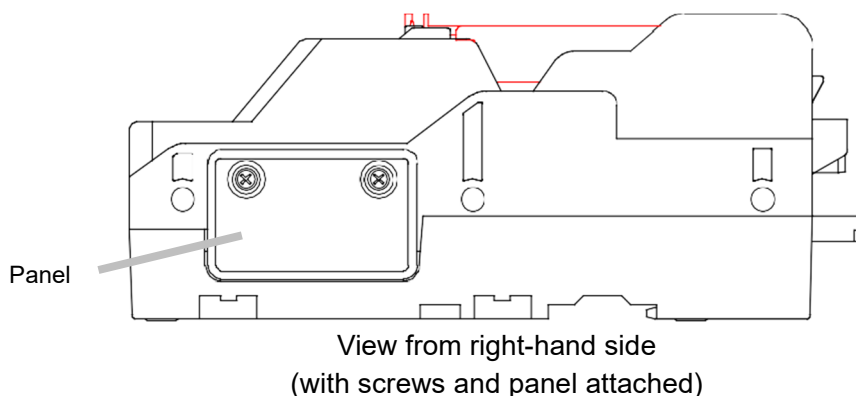

- 3 Remove the two screws securing the panel on the right-hand side of the product.**

Keep the screws, taking care not to lose them.

- 4 Remove the panel.**

Keep the panel, taking care not to lose it.

- 5 Remove the transparent plugs attached to the four sample connectors.**

Keep the plugs, taking care not to lose them.

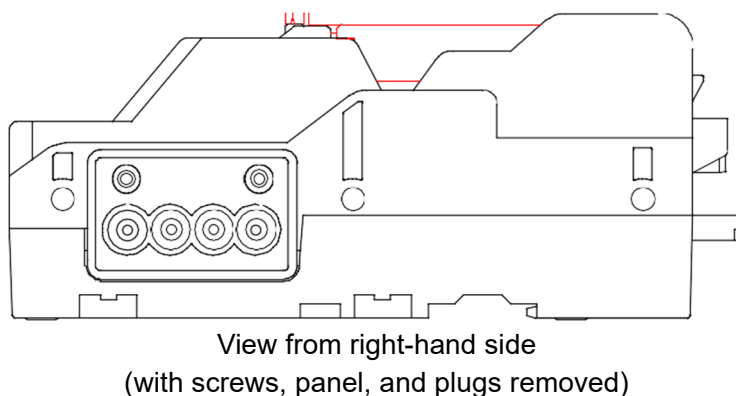

- 6 Align the sample connectors on the two leftmost units, then push in until the two units are in contact with each other.**

- 7 Add a product in the same way as in step 6.**

Leave the right-hand panel attached to the last unit connected.

- 8 Add the connecting fixtures and screws (optional), then secure the two units together at the two connecting points on the base of each unit.**

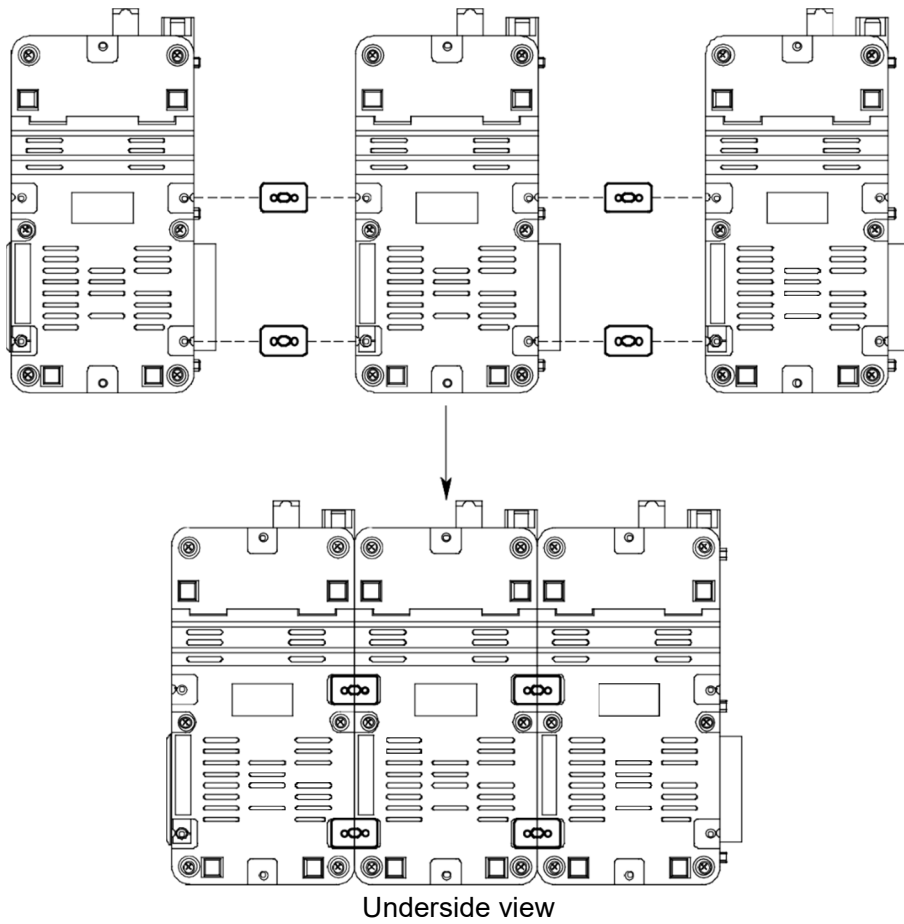

3-2-3. Connecting the AC adapter

- 1 Insert the plug of the AC adapter into the power jack at the rear of the product, then secure the plug with the screw.**



- 2 Plug the AC adapter into the mains outlet.**

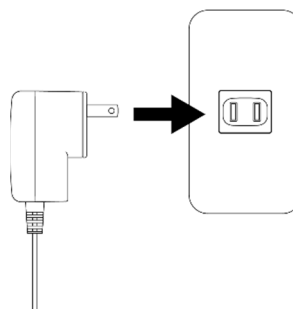

NOTE

- If the product is used connected to other units, each unit must be connected to a separate power supply.

3-2-4. Mounting the gas monitor (sold separately)

<Positioning the lever>

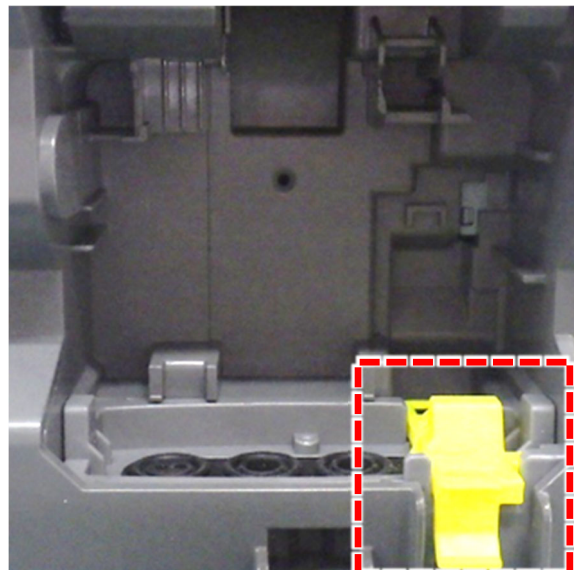
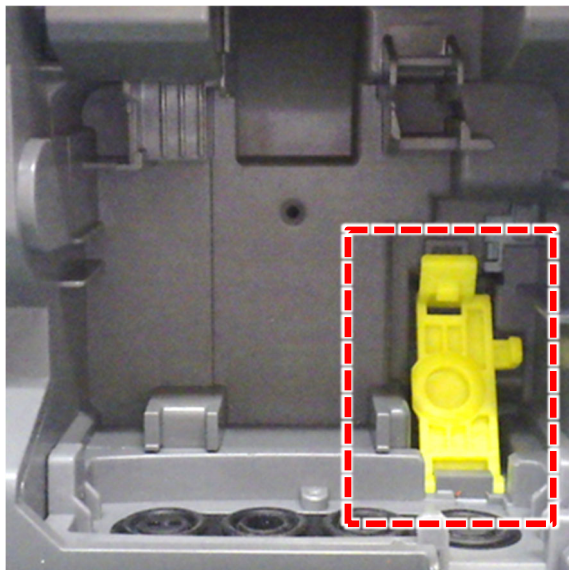

When mounting a GX-3R (sold separately) on the product, raise the yellow lever inside the product docking slot toward you. The lever position does not need to be changed when mounting a GX-3R Pro (sold separately).

Raise the lever until it locks into place with a click. Mount the GX-3R (sold separately) with the lever positioned in this way.

The gas monitor (sold separately) can be mounted with its rubber protection cover and rear clip attached.

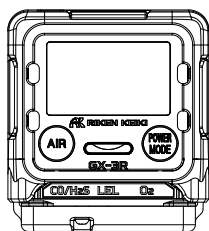

Rubber protection cover

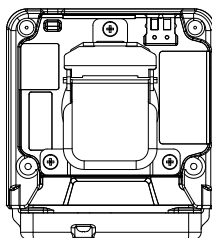

Alligator clip

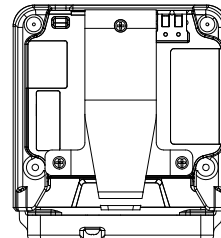

Belt clip

<Mounting the gas monitor (sold separately)>

- 1 Mount the gas monitor (sold separately) from the bottom first**

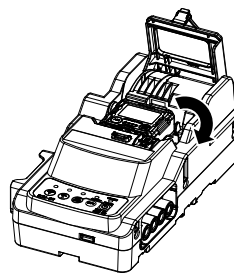

- 2 Close the gas monitor cover on the product.**

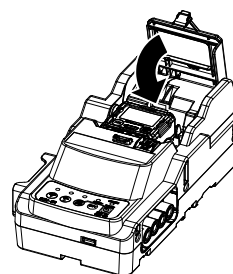

3-2-5. Charging the gas monitor (sold separately)

The product can be used to charge the gas monitor (sold separately).

- 1 Turn on the product power.**

Hold down the POWER button on the product for at least one second to turn on the product power.

All of the LEDs light up in orange, after which the CHARGE LED blinks green.

- 2 Mount the gas monitor (sold separately) with its power turned off on the product.**

Closing the cover on the product automatically turns on the power for the gas monitor (sold separately).

- 3 Press the EDIT/ENTER button and POWER button to turn off the power for the gas monitor (sold separately).**

Turning off the power for the gas monitor (sold separately) automatically starts charging.

<CHARGE LED>

- Charging: Blinking orange
- Charging complete: Steady green
- When a charging error occurs: Steady red

NOTE

- If you use the GX-3R (sold separately) or the GX-3R Pro (sold separately) with the lithium ion battery unit, the product automatically charges for a period of five minutes when the battery level drops to a level that causes a battery voltage error. [CHARGING] is displayed on the screen together with the remaining charging time (minutes and seconds). Once charging is complete, the power turns back on and the gas monitor is connected to the product.
- If you use the GX-3R Pro (sold separately) with the alkaline dry battery unit, [REPLACE] appears on the screen when the battery level drops to a level that causes a battery voltage error. Replace the batteries with new dry batteries.
- Bump test, calibration, and alarm check cannot be performed when [CHARGING] or [REPLACE] is displayed on the screen, even when a switch is pressed.

3-2-6. Connecting the gas

<Connection>

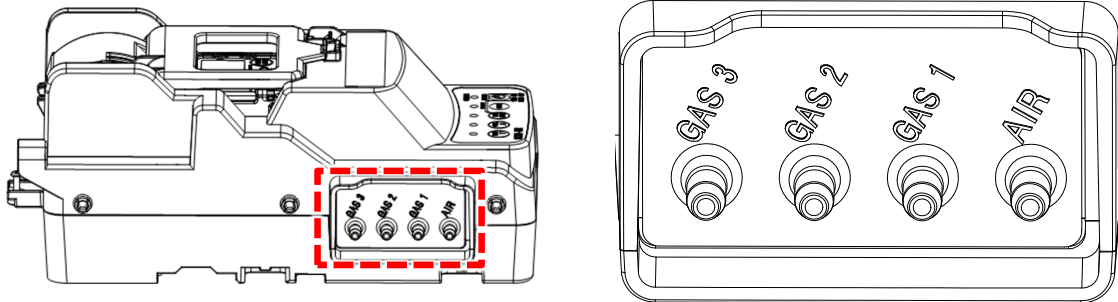

The gas inlets are located on the side of the product.

On products containing one solenoid valve, the gas inlet is GAS 1.

On products containing two solenoid valves, the gas inlets are GAS 1 and GAS 2.

On products containing three solenoid valves, the gas inlets are GAS 1, GAS 2, and GAS 3.

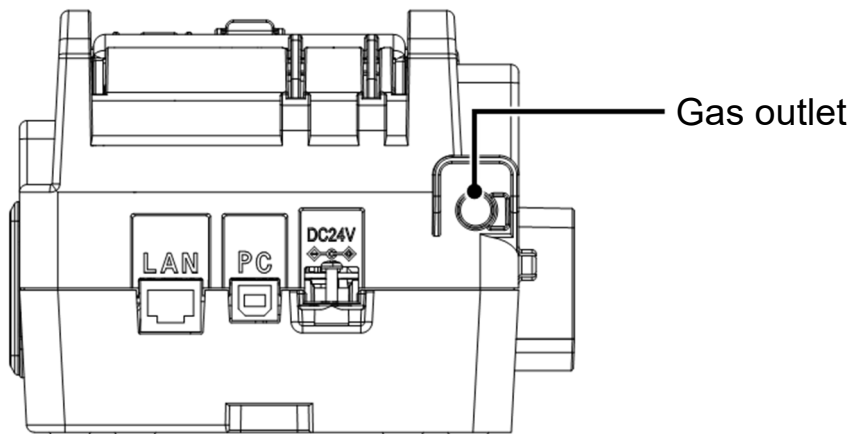

Connectors are located at the rear of the product for connecting to external devices.



WARNING

Bump test and calibration gas

The bump test and calibration gas may be hazardous (combustible or toxic gas) or may cause oxygen deficiency. Handle the gas and related jigs and tools with due care.

Gas sampling bag

Use different gas sampling bags for each gas type and concentration to ensure accurate calibration.

Bump test and calibration location

- Do not perform bump tests or calibration in confined spaces.
- Do not perform bump tests or calibration in an atmosphere where silicone or organic solvents are present.
- Calibrate indoors at normal temperatures with no significant fluctuations (within ± 5 °C).

Gas discharge when units are connected

When the product is used connected to other units, the gas discharge from each unit must be treated individually.



CAUTION

- When feeding gas, it should either be discharged to a safe location with the gas outlet open to the atmosphere or collected using a gas sampling bag.

<Piping>

SDM-3R containing three solenoid valves

Gas can be fed in via any of the three gas inlets GAS 1 to GAS 3. Set the individual gas types fed in via each gas inlet as described in '3-4-2. Cylinder settings'.

If there are insufficient gas inlets for the gas types to be fed in, select CHG (change gas) in the cylinder settings. Gas inlet GAS 3 can be used to feed in and replace gas manually.

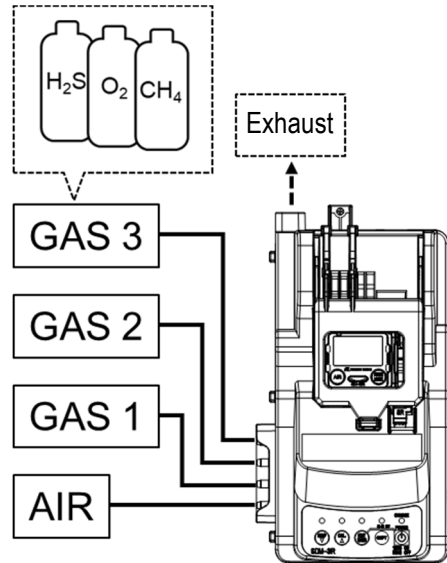

SDM-3R containing one solenoid valve

Gas can be fed in via gas inlet GAS 1 only. To feed in more than one gas type, edit the CHG (change gas) setting in the cylinder settings. During calibration, the next gas must be connected manually after the first gas has been fed in.

* Using a mixture of three gases enables adjustment for three gases at once without manually changing the gases, even with just one gas inlet.

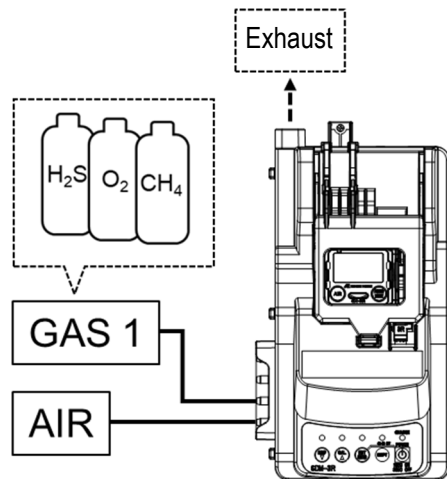

SDM-3R containing two solenoid valves

On products containing two solenoid valves, gas can be fed in via the gas inlets GAS 1 and GAS 2.

If there are insufficient gas inlets for the gas types to be fed in, select CHG in the cylinder settings. Gas inlet GAS 2 can be used to feed in and replace gas manually.

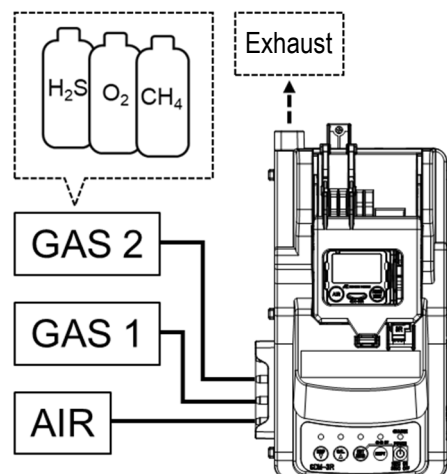

<Piping (using the PC Controller Program (optional))>

SDM-3R containing three solenoid valves

Gas can be fed in via any of the three gas inlets GAS 1 to GAS 3. Set the individual gas types fed in via each gas inlet as described later in 'Operating using the PC Controller Program (optional)'.

Mount the gas monitor (sold separately) on the product, then connect the PC.

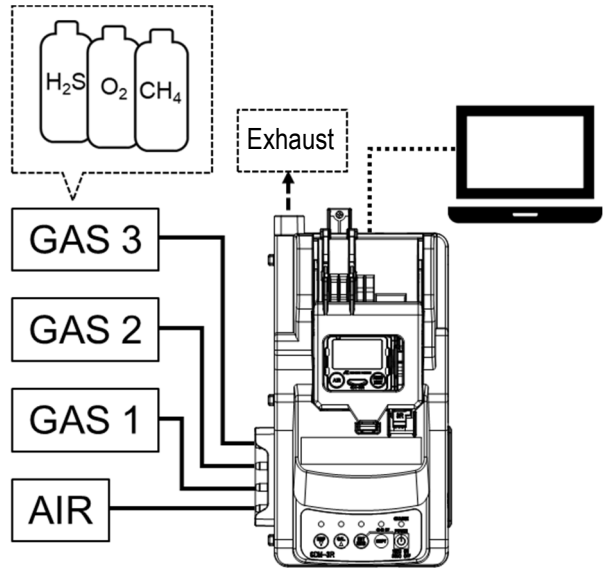

SDM-3R containing one solenoid valve

Gas can be fed in via gas inlet GAS 1 only, in the same way as the piping arrangement when no PC is used.

If more than one gas type is to be fed in, the PC Controller Program must be used to add the gases to be fed in.

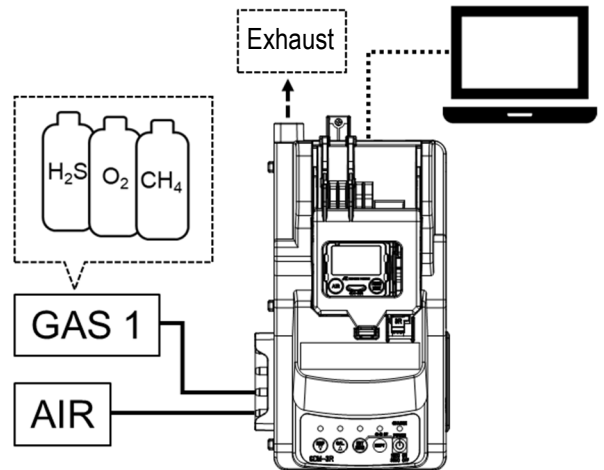

SDM-3R containing two solenoid valves

Gas can be fed in via the gas inlets GAS 1 and GAS 2.

If more than two gas types are to be fed in, the PC Controller Program must be used to add the gases to be fed in.

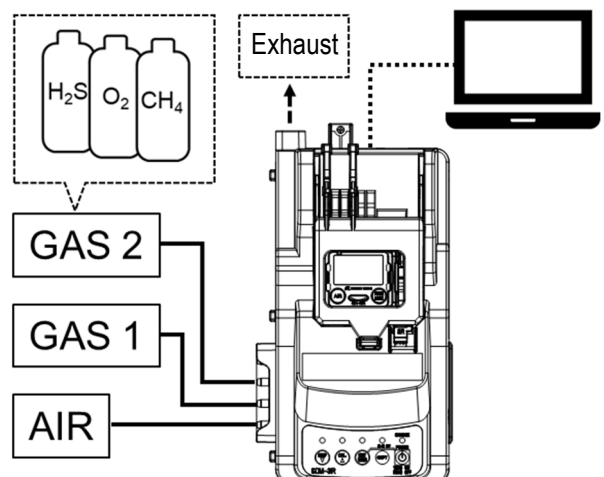

NOTE

- With the default cylinder settings for domestic gas monitor models (sold separately), HC/CH₄, O₂, and CO are assigned to GAS 1, H₂S is assigned to GAS 2, and all other gases are assigned to GAS 3. If using a single gas mixture, H₂S must be set to GAS 1.
 - With ATEX/IECEX gas monitor models, HC/CH₄, O₂, CO, and H₂S are assigned to GAS 1, and all other gases are assigned to GAS 2 and GAS 3.
 - If GAS 2 or GAS 3 are not present due to the number of solenoid valves, these are assigned to CHG O.
 - For information on how to alter the cylinder settings, refer to '3-4-2. Cylinder settings'.
-

3-2-7. Installing the PC Controller Program (optional)

The PC Controller Program (optional) can be installed on a PC to enable calibration using the product to be controlled from the PC.

The PC Controller Program (optional) must be installed before it can be used.

NOTE

- Use a USB cable (Type-A male - Type-B male) (optional) to connect the product to a PC.

<System requirements>

The PC must meet the following system requirements to use the PC Controller Program (optional):

- Operating system (OS): Windows® 8 or Windows® 10
- Processor: Pentium® 2 processor or equivalent operating on an IBM® compatible PC (minimum requirements)
- Memory: 32 MB RAM (minimum)
- Available hard disk space: 32 MB (minimum)
- An available USB port

<Installation>

- 1** Insert the installation CD containing the program into the CD-ROM drive of the PC. The installation screen will appear automatically after a short while.
Do the following if the PC does not support automatic CD-ROM startup:
 1. Open the CD-ROM drive in Explorer.
 2. Double-click on the file "setup.exe".Note: Install using a user account with administrator rights.

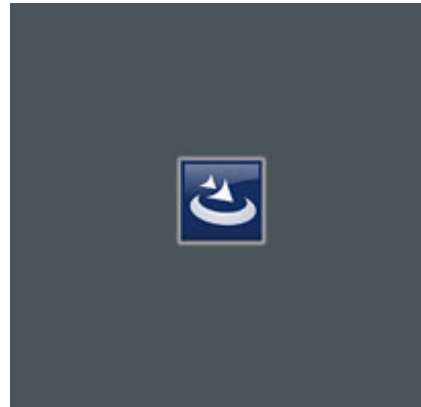

- 2** The installer preparation screen appears. Please wait for a while.

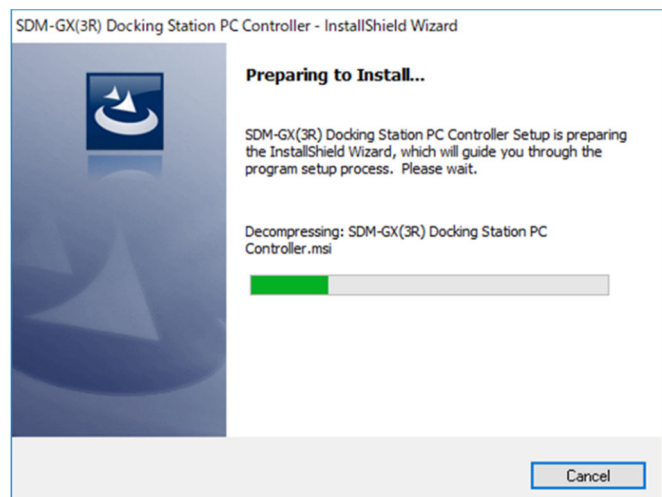

- 3 Click [Next] to proceed.

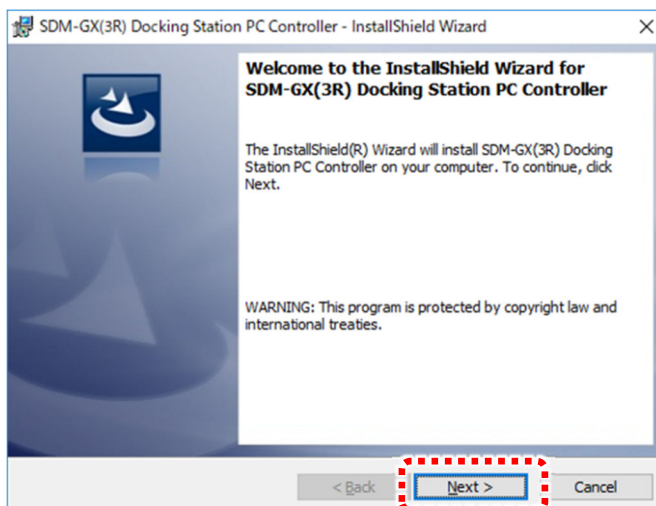

- 4 The License Agreement screen appears. By default, [I do not accept the terms in the license agreement] is selected.

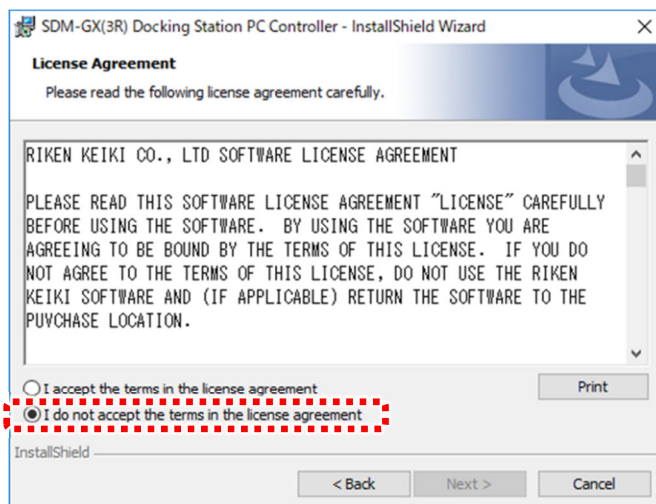

- 5 Read and confirm the details described thoroughly, select [I accept the terms in the license agreement], then click [Next].

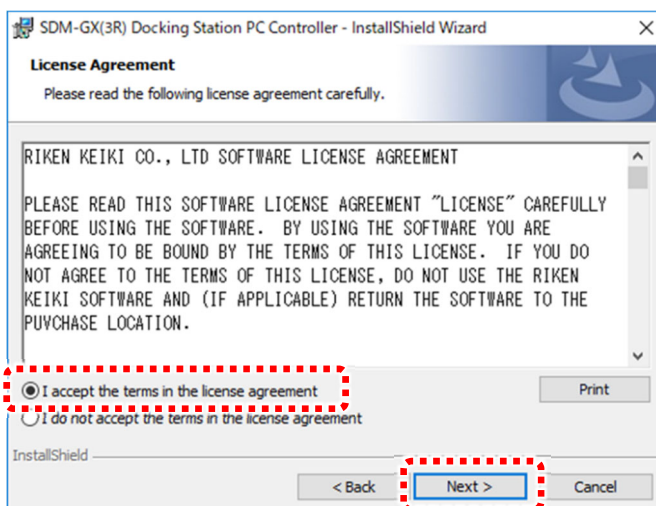

- 6** Enter the user name and organization, then click [Next].

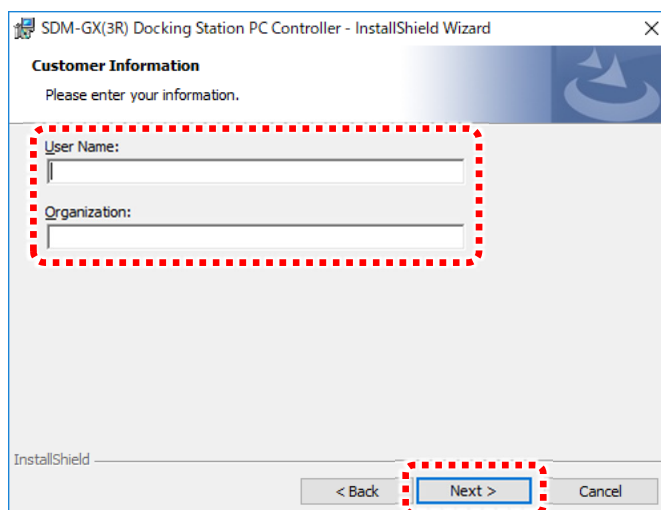

- 7** Select the destination folder for installing the software, then click [Next].

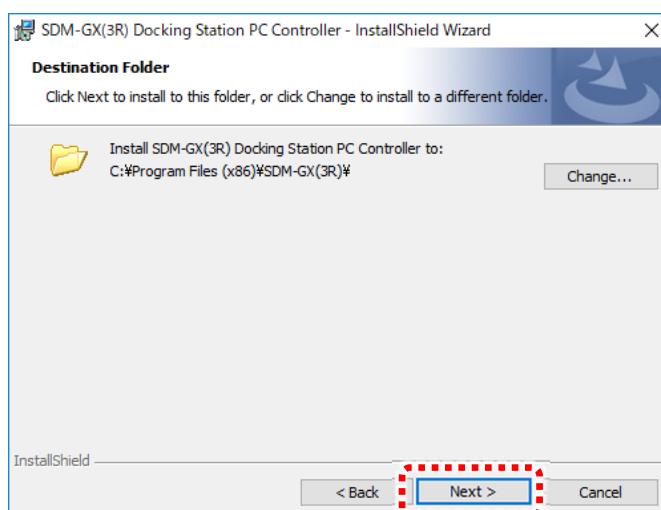

- 8** Check the setup type, destination folder, and user information, then click [Install] to proceed if everything is correct. To edit the settings or information, click [Back]. Click [Cancel] to exit the wizard.

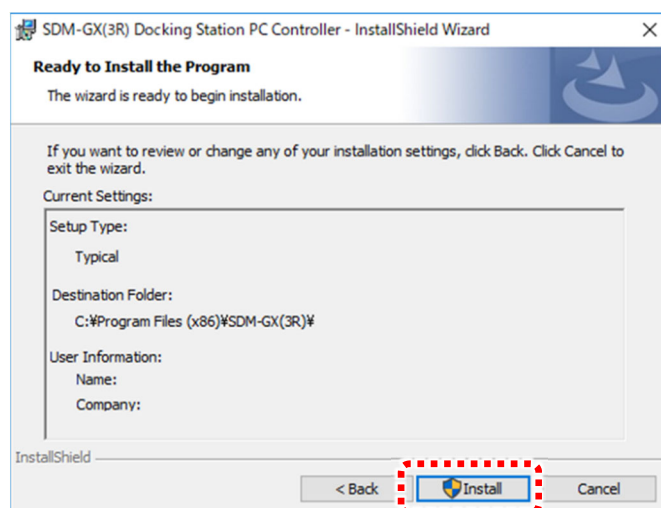

- 9 The device driver install screen appears. Click [Next].



- 10 The installation complete screen appears. Check the details shown, then click [Complete].



- 11 Program installation starts.

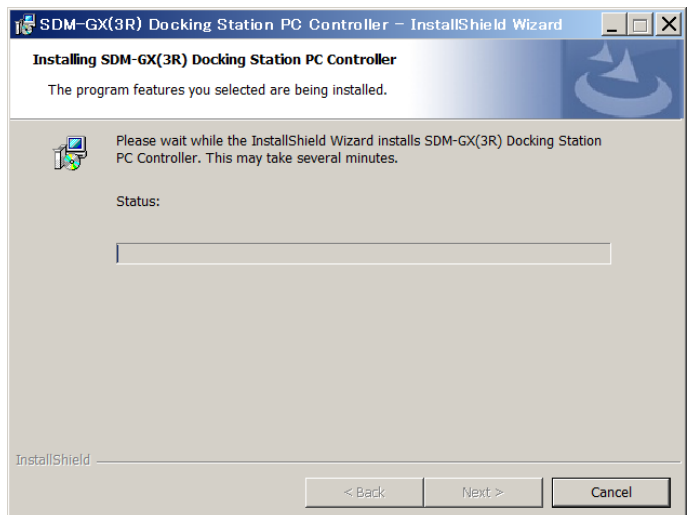

- 12** Click [Finish] to close the window once installation is complete.

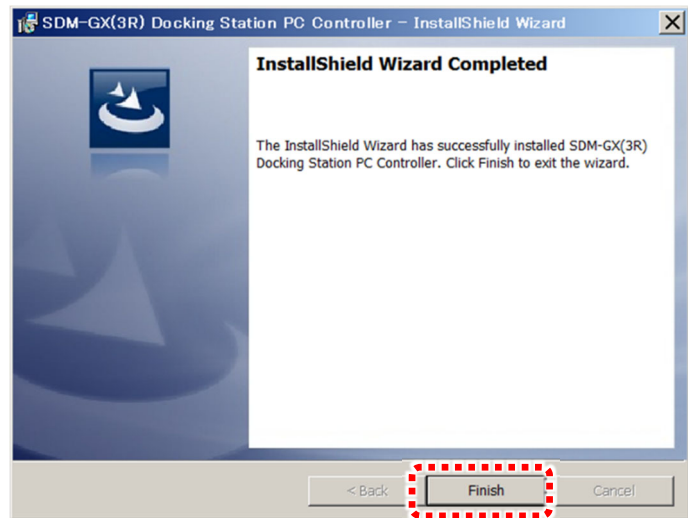

- 13** Check to confirm that the operation software has been installed on the PC desktop (as shown on the right).





3-3. Startup

The screen display examples used in the following description show those displayed when using the GX-3R (sold separately).

3-3-1. Turning on the power

Product LED check locations

| | |
|---|---|
|  |  |
| Lit steadily | Blinking |

- 1 Hold down the POWER button on the product for at least one second to turn on the power.

GX-3R

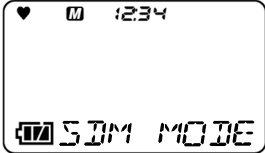

[SDM MODE] appears immediately after communication starts.

SDM-3R

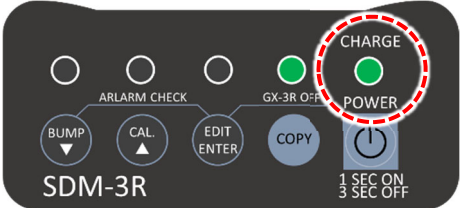

The CHARGE LED blinks green.

- 2 Mount the gas monitor (sold separately) with its power turned off on the product.

GX-3R

—

—

SDM-3R

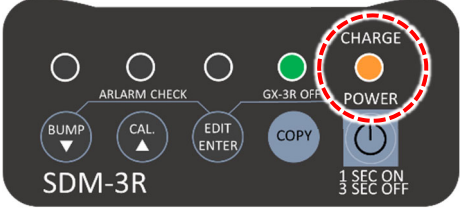

The CHARGE LED blinks orange.

- 3** Closing the gas monitor cover on the product automatically turns on the power for the gas monitor (sold separately), then starts communication with the product.

| |
|--|
| GX-3R |
| — |
| — |
| SDM-3R |
|  |
| The CHARGE LED blinks green. |

- 4** Once communication is established, the gas names and calibration concentrations set on the gas monitor (sold separately) are displayed on the gas monitor (sold separately) LCD.

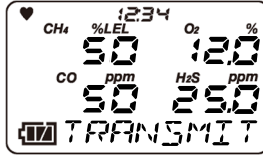
| |
|---|
| GX-3R |
|  |
| Displays the gas names and calibration concentrations. |
| SDM-3R |
| — |
| — |

3-3-2. LED display list

The product LED indications are as follows:

<BUMP LED/CAL LED/ALARM LED>

| Status | | LED | | |
|--|---|----------------------------|-----------------|-----------------------|
| | | BUMP | CAL | ALARM |
| Power on (for one second) | | Orange | Orange | Orange |
| Button operation | Previous results display | (Previous results) | | |
| | Main screen | OFF | OFF | OFF |
| | Set screen | OFF | OFF | OFF |
| Operation using the PC Controller Program (optional) | Download in progress | Blinking orange | Blinking orange | OFF |
| | Download complete | Orange | Orange | OFF |
| Bump/calibration in progress | Bump in progress | Blinking orange | OFF | OFF |
| | Calibration in progress | OFF | Blinking orange | OFF |
| | Calibration in progress after bump failed | Blinking orange | Blinking orange | OFF |
| Bump/calibration results (Normal) | Bump all successful (CAL = OFF after failure) | Green | OFF | (Alarm check results) |
| | Bump failed | Red | OFF | |
| | Calibration all successful | OFF | Green | |
| | Calibration failed | OFF | Red | |
| | Bump all successful (CAL = ON after failure) | Green | OFF | |
| | Bump failed, calibration all successful | Red | Green | |
| | Bump failed, calibration failed | Red | Red | |
| Bump/calibration results (Error) | Zero calibration failed (CAL = OFF after failure) | Blinking red | OFF | (Alarm check results) |
| | Communication error (CAL = OFF after failure) | Red | OFF | |
| | Low flow rate (CAL = OFF after failure) | Blinking green | OFF | |
| | Zero calibration failed (CAL) | OFF | Blinking red | |
| | Communication error (CAL) | OFF | Red | |
| | Low flow rate (CAL) | OFF | Blinking green | |
| | Zero calibration failed (CAL = ON after failure) | Blinking red | OFF | |
| | Communication error (CAL = ON after failure, bump in progress) | Red | Red | |
| | Low flow rate (CAL = ON after failure, bump in progress) | Blinking green | Blinking green | |
| | Communication error (CAL = ON after failure, calibration in progress) | Red | Red | |
| | Low flow rate (CAL = ON after failure, calibration in progress) | Blinking green | Blinking green | |
| Alarm check in progress | Alarm check in progress | OFF | OFF | Blinking orange |
| | Alarm check in progress (after bump) | Blinking orange | OFF | Blinking orange |
| | Alarm check in progress (after bump) | Blinking orange | Blinking orange | Blinking orange |
| | Alarm check in progress (after calibration) | OFF | Blinking orange | Blinking orange |
| Alarm check results | Alarm check successful | (Bump/calibration results) | | Green |
| | Alarm check failed | (Bump/calibration results) | | Red |

* The BUMP and CAL LEDs blink rapidly for fast bump testing.

<COPY LED>

| Status | | LED |
|--|--|-----------------|
| Power on (for one second) | | Orange |
| No USB flash drive (optional) | No data | OFF |
| | Small data volumes (Under 80 %: 1 - 159) | Green |
| | Large data volumes (80 % or more: 160 - 199) | Orange |
| | Max data (100 %: 200) | Red |
| USB flash drive (optional) inserted | No data | OFF |
| | Small data volumes (Under 80 %: 1 - 159) | Blinking green |
| | Large data volumes (80 % or more: 160 - 199) | Blinking orange |
| | Max data (100 %: 200) | Blinking red |
| | Data copying in progress | Red |
| Logger data download in progress | | Blinking orange |

<POWER LED>

| Status | LED |
|---------------------------|-----------------|
| Power on (for one second) | Orange |
| Self-diagnostic error | Red |
| Normal | Blinking green |
| Charging in progress | Blinking orange |
| Charging complete | Green |
| Charging error | Red |

3-4. Settings

Hold down the EDIT/ENTER button for at least three seconds with a gas monitor (sold separately) mounted on the product to display various setting menus.

<Setting items>

BUMP (bump test settings)

| | |
|---|--|
| AIR FLUSH TIME | Duration for which air is aspirated |
| GAS TIME 1 (gas suction time) (for inlet 1) | Time to aspirate gas for bump test |
| GAS TIME 2 (gas suction time) (for inlet 2) | Time to aspirate gas for bump test (Not shown for 1 solenoid valve specification) |
| GAS TIME 3 (gas suction time) (for inlet 3) | Time to aspirate gas for bump test (Not shown for 1 solenoid valve and 2 solenoid valves) |
| AIR PURGE TIME | Duration for air purging of the bump test gas |
| TOLERANCE | Threshold for determining pass/fail of a bump test However, refer to the specific thresholds for fast bump tests. |
| AUTO CAL* | Sets automatic calibration to start if bump test fails. |
| FAST BUMP | Function for testing using a shorter gas suction time (15 seconds) than normal bump testing. This minimizes gas consumption if the sensor reacts normally. The test is passed if the peak sensor value is within the fast bump threshold (fixed). <Thresholds (fixed)> <ul style="list-style-type: none"> • HC/CH₄: ±40 % • O₂: ±10 % • CO: ±30 % • H₂S: ±40 % • CO₂: ±30 % • Other: ±40 % |
| ALARM CHECK | Function for testing the LEDs and buzzer of the gas monitor (sold separately) when bump testing has ended. Testing lights up the LEDs for several seconds and sounds the buzzer, and the product assesses whether these are operating correctly. |
| BUMP EXPIRED (run when bump expired) | Sets so that bump testing starts automatically when a gas monitor (sold separately) for which the bump test has expired is connected. |
| AUTO EXEC (run automatic bump test) | Sets so that bump testing starts automatically when a gas monitor (sold separately) is connected. |

* The gas concentration for AUTO CAL must be set on the gas monitor (sold separately).

CAL (calibration settings)

| | |
|---|---|
| AIR FLUSH TIME | Duration for which air is aspirated |
| GAS TIME 1 (Gas suction time) (for inlet 1) | Time to aspirate gas for gas calibration |
| GAS TIME 2 (Gas suction time) (for inlet 2) | Time to aspirate gas for gas calibration (Not shown for 1 solenoid valve specification) |
| GAS TIME 3 (Gas suction time) (for inlet 3) | Time to aspirate gas for gas calibration (Not shown for 1 solenoid valve and 2 solenoid valves) |
| AIR PURGE TIME | Duration for air purging of the calibration gas |
| ALARM CHECK | Function for testing the LEDs and buzzer of the gas monitor (sold separately) when calibration has ended. Testing lights up the LEDs for several seconds and sounds the buzzer, and the product assesses whether these are operating correctly. |
| CAL EXPIRED (run when calibration expired) | Sets so that calibration starts automatically when a gas monitor (sold separately) for which the calibration has expired is connected. |
| AUTO EXEC (run automatic calibration) | Sets so that calibration starts automatically when a gas monitor (sold separately) is connected. |
| MANUAL CAL | Sets so that calibration can be performed by pressing the CAL button. If set to OFF, calibration will not be performed even when the CAL button is pressed. [AUTO CAL] in the BUMP settings will also be set to OFF. |

3-4-1. Setting list

| Menu | | Item | Default value | Setting range |
|------------------------------|--------------------------------------|--|---------------|-------------------|
| BUMP (bump test settings) | | AIR FLUSH TIME | 15 seconds | 15 - 180 seconds |
| | | GAS TIME | 25 seconds | 20 - 120 seconds |
| | | AIR PURGE TIME | 15 seconds | 5 - 180 seconds |
| | | TOLERANCE | ±50 % | ±10 - 50 % |
| | | AUTO CAL* | ON | ON/OFF |
| | | FAST BUMP | ON | ON/OFF |
| | | ALARM CHECK | ON | ON/OFF |
| | | BUMP EXPIRED (run when bump expired) | OFF | ON/OFF |
| | AUTO EXEC (run automatic bump test) | OFF | ON/OFF | |
| CAL (calibration settings) | | AIR FLUSH TIME | 15 seconds | 15 - 180 seconds |
| | | GAS TIME | 60 seconds | 20 - 120 seconds |
| | | AIR PURGE TIME | 15 seconds | 5 - 180 seconds |
| | | ALARM CHECK | ON | ON/OFF |
| | | CAL EXPIRED (run when calibration expired) | OFF | ON/OFF |
| | | AUTO EXEC (run automatic calibration) | OFF | ON/OFF |
| | | MANUAL CAL | ON | ON/OFF |
| CYLINDER (cylinder settings) | Single solenoid valve specifications | OFF/GAS 1/CHG 1 | - | - |
| | Two solenoid valve specifications | OFF/GAS 1/GAS 2/CHG 2 | - | - |
| | Three solenoid valve specifications | OFF/GAS 1/GAS 2/GAS 3/CHG 3 | - | - |
| PASSWORD (password settings) | | (Password protection ON/OFF) | OFF | ON/OFF |
| | | (Password for setting menus) | 0000 | Four-digit number |

* The gas concentration for AUTO CAL must be set on the gas monitor (sold separately).

NOTE

- With the default cylinder settings for domestic gas monitor models (sold separately), HC/CH₄, O₂, and CO are assigned to GAS 1, H₂S is assigned to GAS 2, and all other gases are assigned to GAS 3. If using a single gas mixture, H₂S must be set to GAS 1.
- With ATEX/IECEx models, HC/CH₄, O₂, CO, and H₂S are assigned to GAS 1, and all other gases are assigned to GAS 2 and GAS 3.
- If GAS 2 or GAS 3 are not present due to the number of solenoid valves, these are assigned to CHG 0.
- For information on how to alter the cylinder settings, refer to '3-4-2. Cylinder settings'.

NOTE

- When using the buttons to operate the product (independently)
The following settings are retained when the product settings are altered, and are used the next time a gas monitor (sold separately) of the same model and the same combination of sensors is used, regardless of the gas monitor settings. There is no need to alter the settings each time. Note that changing the settings on the product does not change the settings for the gas monitor itself.

| Menu | Whether or not setting is possible on gas monitor | Source for settings when this product is used |
|-------------------------------|---|---|
| BUMP (bump test settings) | × | The product |
| CAL (calibration settings) | × | |
| CYLINDER (cylinder settings) | ○ | |
| DATE (date and time settings) | ○ | |
| PASSWORD (password settings) | × | |

However, for items other than CYLINDER and DATE, which can be set on the gas monitor (for example, calibration gas concentration), the gas monitor settings are used for bump testing and calibration even when the product is used. Therefore, if bump test or calibration gas is used with a different concentration from the default setting, the setting must be changed on all gas monitor units (or using the PC Controller Program (optional)).

- Using the product together with the PC Controller Program (optional)
The ability to alter gas monitor (sold separately) and product settings using the PC Controller Program (optional) is outlined in the following table.

| Setting item | Ability to alter gas monitor settings | Ability to alter product settings |
|---|---------------------------------------|-----------------------------------|
| Items that can be altered by right-clicking the display icon, then selecting [Edit] ^{*1} <ul style="list-style-type: none"> Cylinder settings Bump test/calibration gas concentration Gas alarm setpoints, etc. | ○ | ○ |
| Items that can be altered by selecting [Config] ^{*2} displayed at the top right of the PC software screen. <ul style="list-style-type: none"> Bump test settings Calibration settings, etc. | × | × |

*1: Password entry is required to select [Edit]. Password (default): 1939

*2: Password entry is required to select [Config]. Password (default): ABCDE

3-4-2. Cylinder settings

These set the gas inlets used to feed in individual test gases. Configure the cylinder settings once the gas monitor (sold separately) is mounted on the product.

* The cylinder settings are saved separately for each sensor combination and gas monitor (sold separately). (up to 10 settings).

- 1 With the gas monitor (sold separately) mounted on the product, hold down the EDIT/ENTER button to display the setting screen.

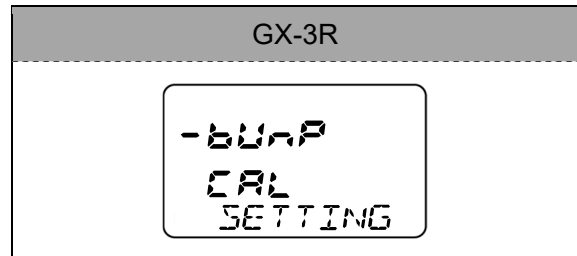

- 2 Press the BUMP or CAL button to move the selection cursor to [CyLndEr] (Cylinder) on the setting screen. Press the EDIT/ENTER button to select the cylinder settings.

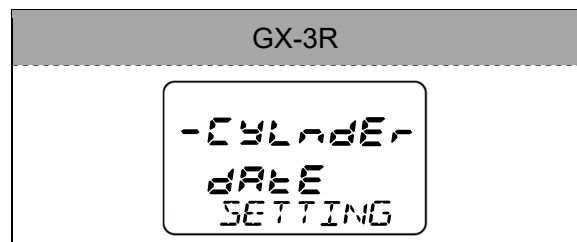

- 3 Set the cylinder number for each gas type. Press the BUMP or CAL button to select the item to be set, then press the EDIT/ENTER button to confirm. The setting item blinks when confirmed. The setting items are cycled through in the sequence HC/CH₄→O₂→H₂S→CO.

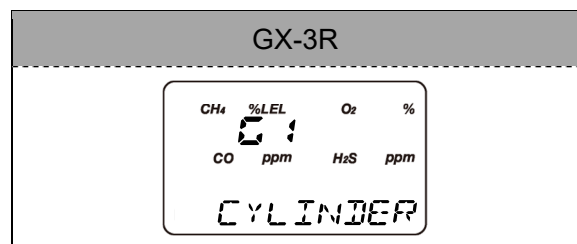

- 4 Press the BUMP or CAL button while the setting item is blinking to select the cylinder number. Press the EDIT/ENTER button to confirm the setting. The cylinder numbers that can be selected will vary depending on the number of solenoid valves inside the product.

- With one solenoid valve, OFF/GAS 1/CHG 1 can be selected.
 - * If CHG 1 is selected, the GAS 1 inlet forms the inlet for gas replacement.

- With two solenoid valves, OFF/GAS 1/GAS 2/CHG 2 can be selected.
 - * If CHG 2 is selected, the GAS 2 inlet forms the inlet for gas replacement.

- With three solenoid valves, OFF/GAS 1/GAS 2/GAS 3/CHG 3 can be selected.
 - * If CHG 3 is selected, the GAS 3 inlet forms the inlet for gas replacement.

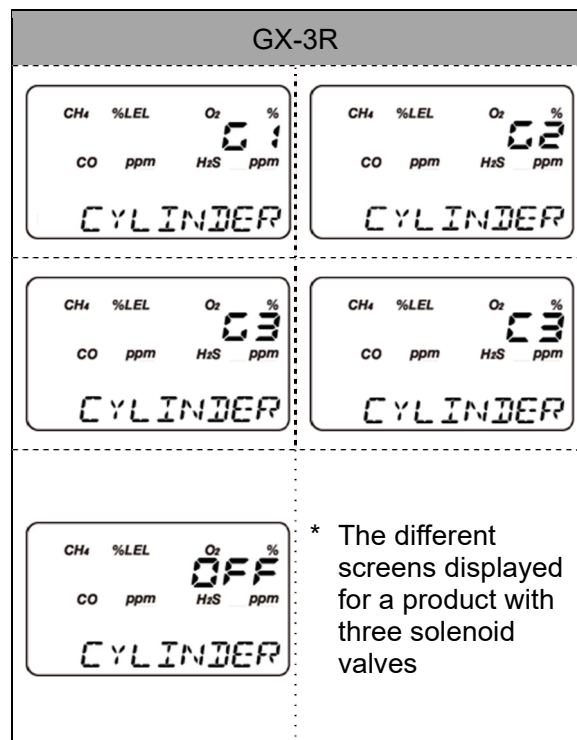

- 5** If set to OFF, gas will not be fed in.

* In the case of a gas monitor (sold separately) containing a carbon monoxide sensor (ESR-A1CP), disabling the CO setting will hide the CO display on all screens other than the cylinder setting screen.

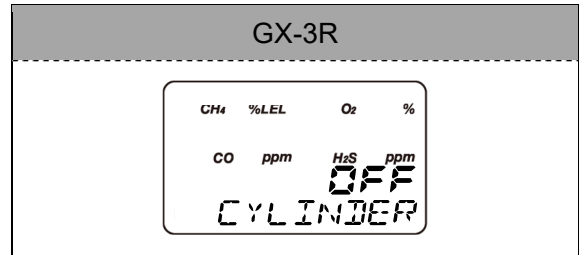

- 6** Press the BUMP button on the setting screen for the last gas type to save the settings. [DECISION] is displayed on the gas monitor (sold separately) screen, and the display then returns to the setting screen.

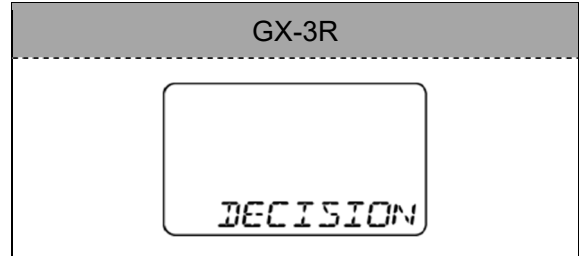

- 7** Press the BUMP or CAL button to move the selection cursor to [ESCAPE] on the setting screen. Press the EDIT/ENTER button to return to the measurement screen.

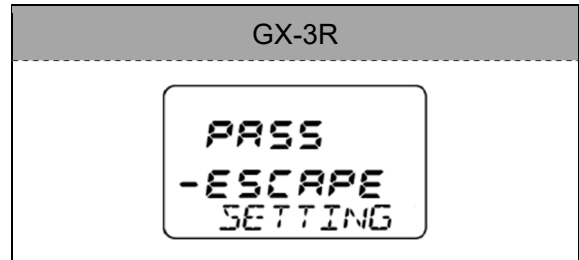

3-5. Operations using the product operation buttons

3-5-1. Bump test and calibration procedure

NOTE

- Bump testing and calibration can be canceled midway by holding down the BUMP button or CAL button respectively for at least three seconds.
- Canceling during the initial air aspiration (AIR FLUSH) aborts the procedure immediately and the display returns to the main screen. In this case, the canceled procedure is not recorded in the product memory.
- Air aspiration (AIR PURGE) is performed if the procedure is canceled while gas is being aspirated. [CANCEL] is displayed while air is being aspirated, and the result screen is displayed once the air aspiration has ended.
- If at least one bump test or calibration has ended, the procedure is performed to the end, and the results are displayed. In this case, the results are also stored in the internal memory.
- The number of gas inlets that can be used on the product varies depending on the number of solenoid valves (one to three) contained.
- On products containing one solenoid valve, the gas inlet is GAS 1 only. To feed in more than one type of gas with this model, CHG must be set, and the gas connected to the gas inlet on the product must be changed over manually.

Product LED check locations

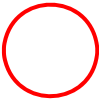
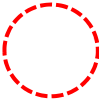
| | |
|--|--|
|  |  |
| Lit steadily | Blinking |

- 1 Hold down the POWER button on the product for at least one second to turn on the power.

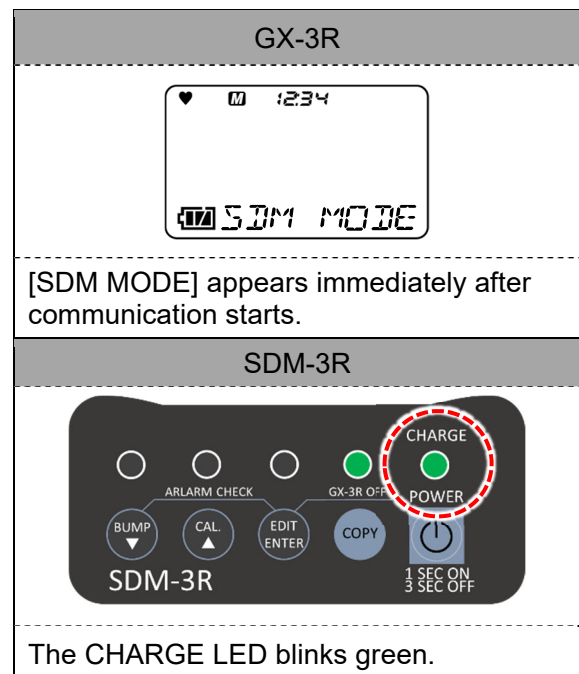

- 2 Mount the gas monitor (sold separately) with its power turned off on the product.

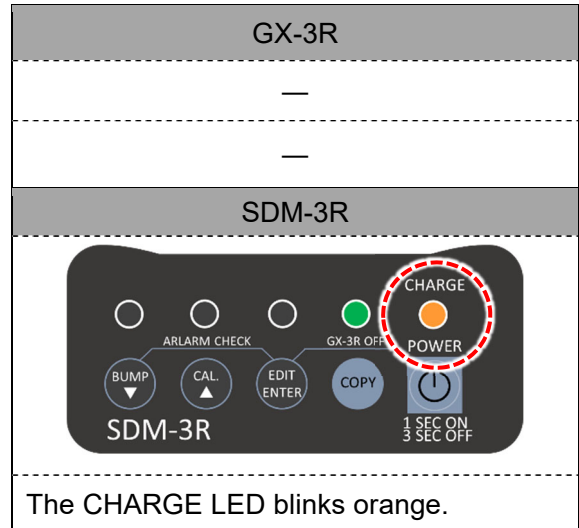

- 3 Closing the gas monitor cover on the product automatically turns on the power for the gas monitor (sold separately), then starts communication with the product.

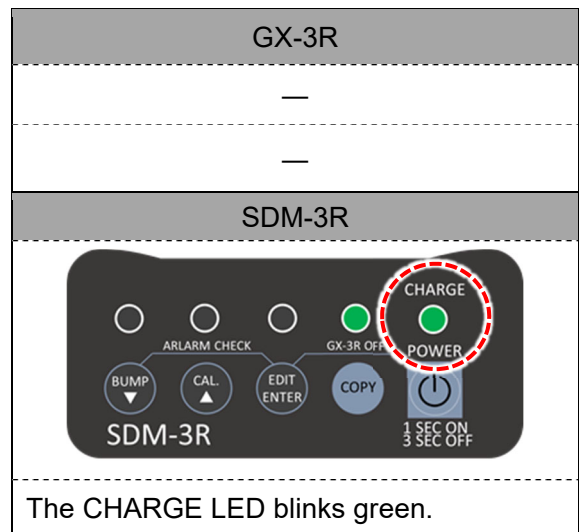

- 4 Once communication is established, the gas names and calibration concentrations set on the gas monitor (sold separately) are displayed on the gas monitor (sold separately) LCD.

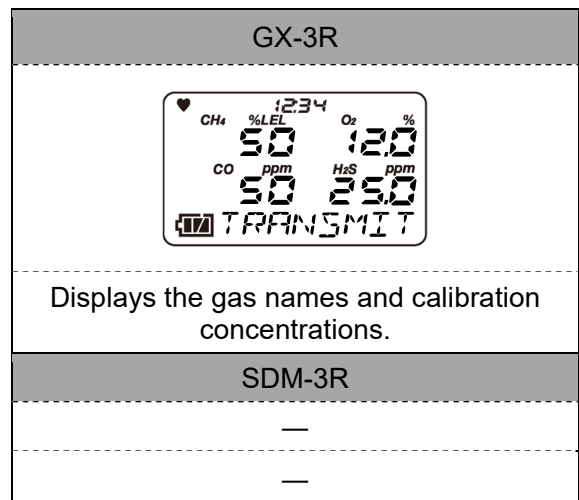

- 5 Press the BUMP button to start bump testing and perform a bump test for all gas types.

| |
|--|
| GX-3R |
| |
| The current concentration is displayed while a bump test is in progress. |
| SDM-3R |
| |
| The BUMP LED blinks orange. |

- 6 Press the CAL button to start calibration and perform calibration for all gas types. The current concentration is displayed while calibration is in progress.

| |
|--|
| GX-3R |
| |
| The current concentration is displayed while calibration is in progress. |
| SDM-3R |
| |
| The CAL LED blinks orange. |

Common details for bump testing and calibration



- 7 Air is aspirated for zero adjustment. Zero adjustment is performed for all sensors simultaneously.
- * In the case of gas monitors with an O₂ sensor, air aspiration is extended for 40 seconds, after the gas monitor (sold separately) is connected.

| |
|--------|
| GX-3R |
| — |
| — |
| SDM-3R |
| — |
| — |



- 8** Bump testing and calibration are performed in the order set in the cylinder settings.
- Adjustment is performed from the gas set for GAS 1.
 - If set in CHG, the gas is exchanged before bump testing and calibration.

| |
|--------|
| GX-3R |
| — |
| — |
| SDM-3R |
| — |
| — |

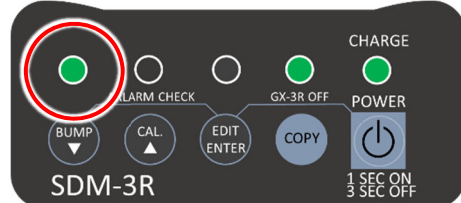
- 9** The results are displayed. (Bump test)

| GX-3R: Evaluation | | GX-3R: Concentration results |
|---|--|---|
|  |  |  |
| [P] is displayed if successful, and [F] is displayed if failed. | Screens displayed alternately | The results are displayed on the gas monitor (sold separately) screen. |
| SDM-3R | | |
|  | | |
| <p>The BUMP LED lights up green if all bump tests were successful. The BUMP LED lights up red if even one bump test failed.</p> | | |

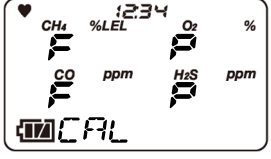
- 10** The results are displayed. (Calibration)

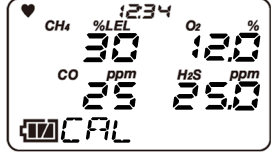
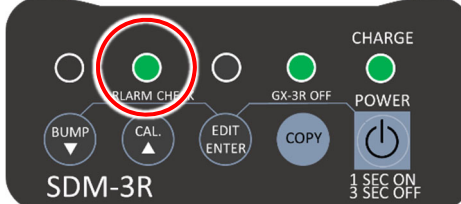
| GX-3R: Evaluation | | GX-3R: Concentration results |
|---|--|---|
|  |  |  |
| [P] is displayed if successful, and [F] is displayed if failed. | Screens displayed alternately | The results are displayed on the gas monitor (sold separately) screen. |
| SDM-3R | | |
|  | | |
| <p>The CAL LED lights up green if all calibrations were successful. The CAL LED lights up red if even one calibration failed.</p> | | |

- 11** Press the BUMP button and EDIT/ENTER button simultaneously to start the alarm check.

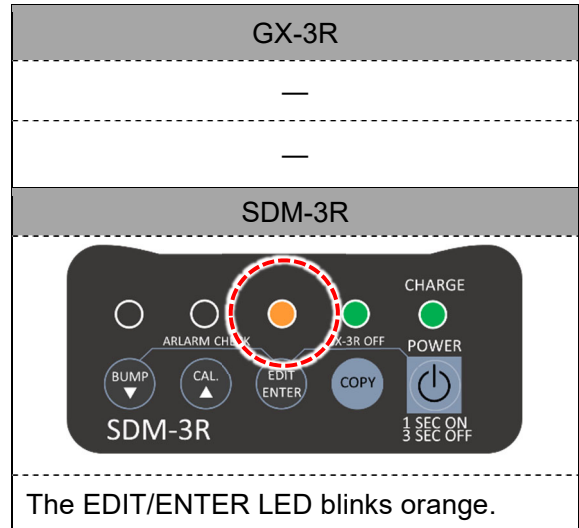

The EDIT/ENTER LED blinks orange.

- 12** Once the alarm check ends, the result screen is displayed, and the LED indication changes from blinking orange.
- * The LED lights up green if all alarm checks were successful.
 - The LED lights up red if even one alarm check failed.

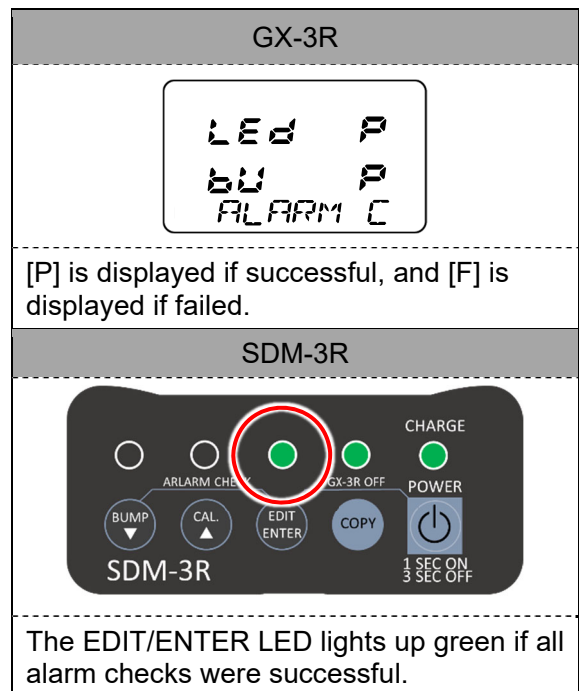

[P] is displayed if successful, and [F] is displayed if failed.

The EDIT/ENTER LED lights up green if all alarm checks were successful.

3-5-2. Copying test/calibration results to a USB flash drive (optional)

The results of bump tests, calibration, and alarm checks performed on the product can be saved as a text file to a USB flash drive (optional).

NOTE

- Up to 200 data items can be stored in the product.
- If the product memory becomes full, the oldest data will be overwritten by new data.
- Data is saved as text files (.txt) in the DAT folder.
- The file names begin with "SDM3R", and consist of the product serial number, suffixed by the date of the last test or calibration performed.
Example: SDM3RTEST0000003180111.TXT
→ Data for the last test or calibration performed on January 11, 2018 using the product with serial number TEST0000003
- The COPY LED color varies depending on the amount of memory space available. For details, refer to '3-3-2. LED display list'.

- USB flash drives with a built-in hub cannot be used.
- Data cannot be copied unless the USB flash drive (optional) has sufficient free space in which to copy the saved data.

Product LED check locations

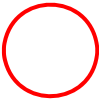
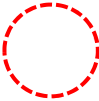
| | |
|---|---|
|  |  |
| Lit steadily | Blinking |

- 1 Hold down the POWER button on the product for at least one second to turn on the power.

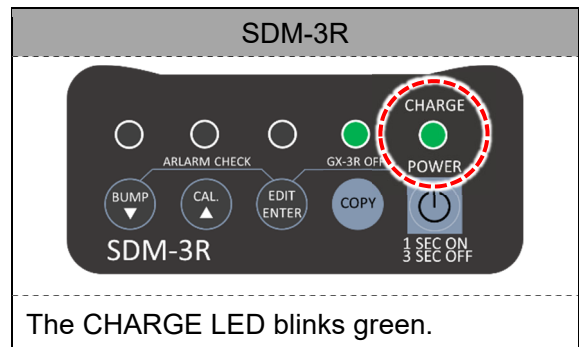

- 2 Insert the USB flash drive (optional) into the USB port on the front of the product.

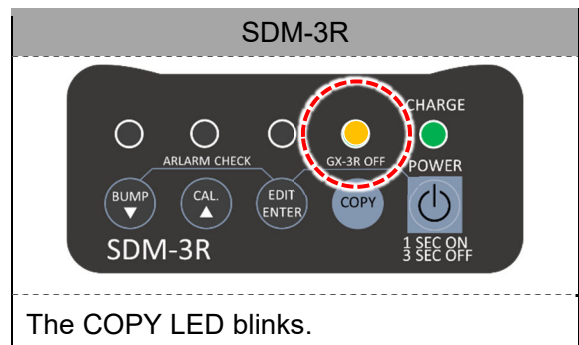

- 3 Hold down the COPY button on the product until the COPY LED lights up red.

The bump test, calibration, and alarm check data stored in the product is copied to the USB flash drive (optional).
Once copying is complete, the COPY LED returns to its previous state.

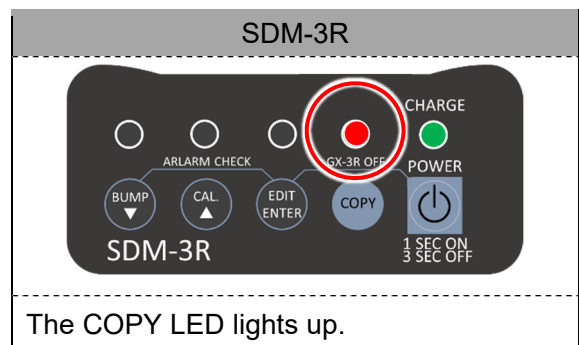

NOTE

- Holding down the CAL/▲ button and COPY button together for at least three seconds after turning on the product power in step 1 clears all of the data inside the product. The COPY LED goes out after the memory has been cleared.

<Example of recorded data>

▪ Bump test

Model : GX-3R
Serial No : *****
Station ID : *****
User ID : *****
SDM Model : SDM-3R
SDM Serial No : SDM-3R_20171227
Date Time : 2018/03/05 10:48:32
Item : BUMP TEST
Gas Name : CH4(%LEL) O2(%) H2S (ppm) CO (ppm)
Test Gas : 50 12.0 25.0 50
Test Result : 49 12.0 25.0 10
Pass/Fail? : PASS PASS PASS FAIL
Result Time1 : 2018/03/05 10:49:33
Result Time2 : 2018/03/05 10:49:33
Result Time3 : 2018/03/05 10:50:03
Result Time4 : 2018/03/05 10:49:33

▪ Calibration

Model : GX-3R
Serial No : *****
Station ID : *****
User ID : *****
SDM Model : SDM-3R
SDM Serial No : SDM-3R_20171227
Date Time : 2018/03/06 10:48:32
Item : CALIBREATION
Gas Name : CH4(%LEL) O2(%) H2S (ppm) CO (ppm)
Full Scale : 100 40.0 200.0 2000
Cal Gas : 50 12.0 25.0 50
Before Cal : 45 11.0 30.0 55
After Cal : 50 12.0 30.0 55
Pass/Fail? : PASS PASS FAIL PASS
Result Time1 : 2018/03/05 10:49:33
Result Time2 : 2018/03/05 10:49:33
Result Time3 : 2018/03/05 10:50:03
Result Time4 : 2018/03/05 10:49:33

▪ Alarm check

Model : GX-3R
Serial No : *****
Station ID : *****
User ID : *****
SDM Model : SDM-3R
SDM Serial No : SDM-3R_20171227
Date Time : 2018/03/06 10:48:32
Item : ALARM CHECK
Test Type : LED BUZZER
Pass/Fail? : PASS PASS

3-5-3. Downloading gas monitor (sold separately) logger data

Logger data saved in a gas monitor (sold separately) can be downloaded to a USB flash drive (optional). The downloaded data can then be imported into the PC Controller Program (optional).

NOTE

- The data is saved as binary files in the DAT folder.
- The PC Controller Program (optional) and a USB cable (Type-A male - Type-B male) (optional) are required in order to import downloaded data. For information on how to install the PC Controller Program (optional), refer to '3-2-7. Installing the PC Controller Program (optional)'.
- The file names are made up of the gas monitor (sold separately) model and the serial number. Example: GX-3RPro860010016RK.DAT
→ Logger data for the gas monitor (sold separately) model GX-3R Pro with serial number 860010016RK

- 1 Hold down the POWER button on the product for at least one second to turn on the power.

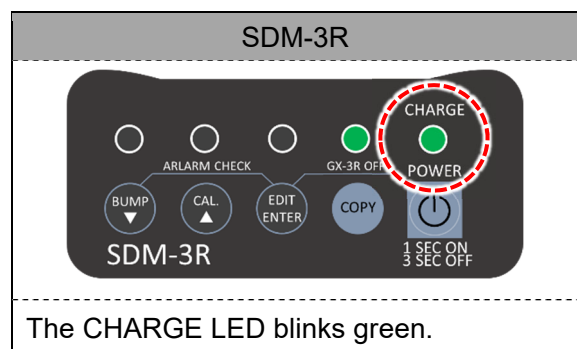

- 2 Insert the USB flash drive (optional) into the USB port on the front of the product.

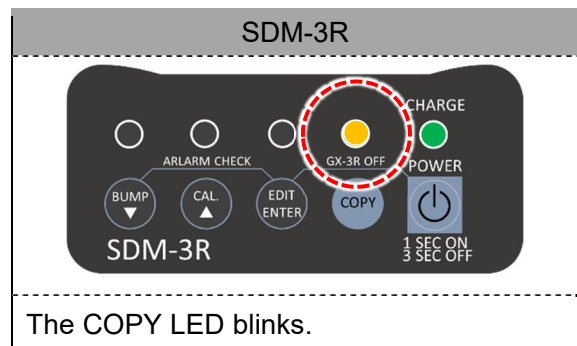

- 3 After the COPY LED lights up red, hold down the COPY button on the product until the LED blinks orange.

The product downloads the gas monitor (sold separately) logger data to the USB flash drive (optional).

Downloading can be canceled by holding down the COPY button here.

Once downloading is complete, the gas monitor (sold separately) display returns to the previous screen, and the COPY LED returns to its previous state.

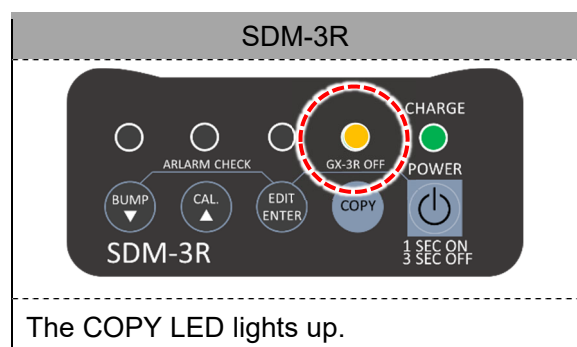

3-6. Operating using the PC Controller Program (optional)



3-6-1. Bump test and calibration procedure

Calibration and other operations can be controlled from a PC by connecting the PC to the product. Connecting to a PC allows a calibration certificate to be produced.

NOTE

- The PC Controller Program (optional) and a USB cable (Type-A male - Type-B male) (optional) are required in order to control the product from a PC. For information on how to install the PC Controller Program (optional), refer to '3-2-7. Installing the PC Controller Program (optional)'.
- Certain items in the PC Controller Program (optional) are password-protected. The password can be changed using [Config] at the top right of the main screen.
Main screen → Right-click on the gas monitor icon → [Edit]: 1939 (default setting)
Main screen → [Config] at top right: ABCDE (default setting)

Product LED check locations

| | |
|---|---|
|  |  |
| Lit steadily | Blinking |

- 1 Hold down the POWER button on the product for at least one second to turn on the power.

| PC screen | GX-3R |
|-----------|--|
| — | — |
| — | — |
| — | <div style="background-color: #cccccc; padding: 2px; text-align: center;">SDM-3R</div>  |
| — | The CHARGE LED blinks green. |

- 2** Start up the PC, then connect the product to the PC using the USB cable (optional).
 * USB cable (optional): Use a Type-A male - Type-B male USB cable.

| PC screen | GX-3R |
|-----------|--|
| — | — |
| — | — |
| | <p data-bbox="1042 434 1444 488">SDM-3R</p>  |
| — | <p data-bbox="1042 792 1444 871">Connect to the PC using a USB cable (sold separately).</p> |

- 3** Double-click the icon on the PC to launch the maintenance software.

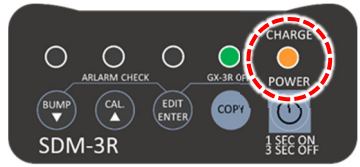
| PC screen | GX-3R |
|--|--|
| | — |
| | — |
|  | <p data-bbox="1042 1173 1444 1227">SDM-3R</p>  |
| <p data-bbox="223 1476 1042 1556">The software launches and docking with the product starts.</p> | <p data-bbox="1042 1476 1444 1556">The CHARGE LED blinks orange.</p> |

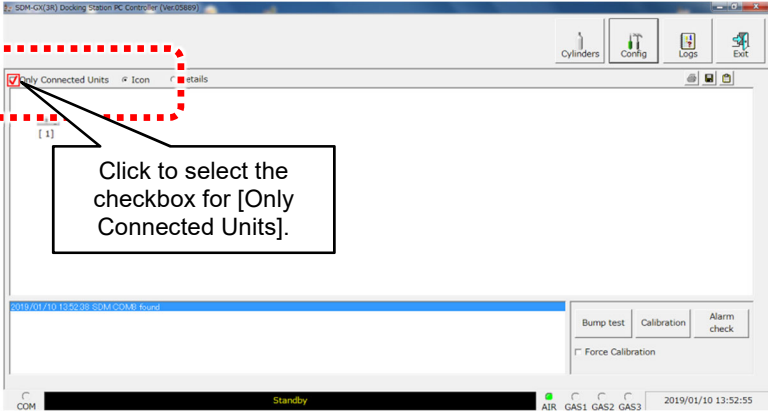
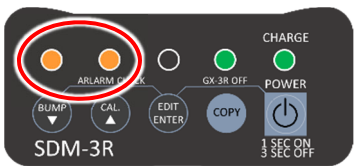

4 Mount the gas monitor (sold separately) with its power turned off on the product.

| PC screen | GX-3R |
|--|---|
|  |  |
| <p>Check the checkbox for [Only Connected Units] on the screen.</p> | <p>The BUMP and CAL LEDs both light up orange.</p> |

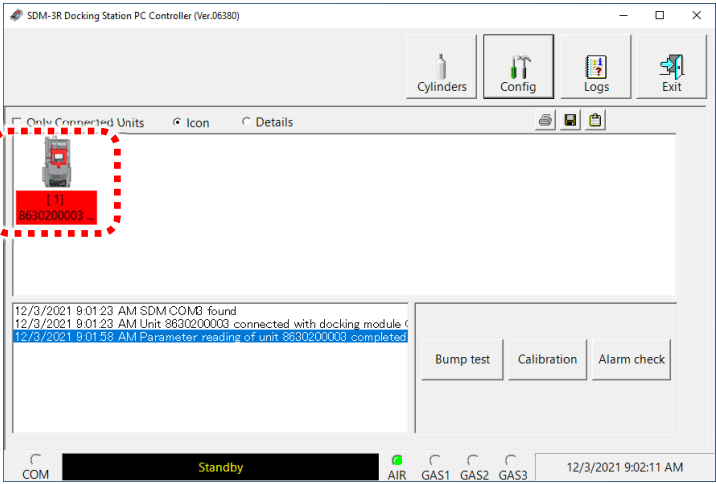
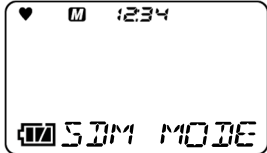
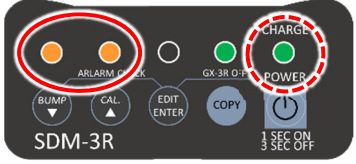
5 The power for the gas monitor (sold separately) turns on, then communication with the product starts.

| PC screen | GX-3R |
|---|---|
|  |  |
| <p>The icon is displayed for the model connected to the PC.</p> |  <p>The CHARGE LED blinks green. The BUMP and CAL LEDs both light up orange.</p> |

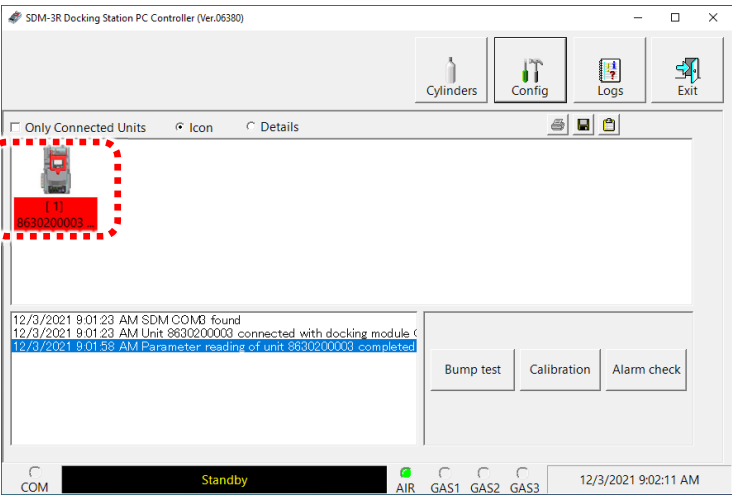
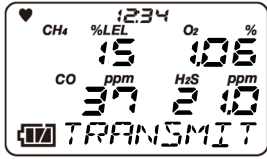
- 6 Once communication is established, the gas names and calibration concentrations set on the gas monitor (sold separately) are displayed on the gas monitor (sold separately) LCD.

| PC screen | GX-3R |
|--|--|
|  |  |
| <p>The icon is displayed for the model connected to the PC.</p> | <p>Once communication is established, [TRANSMIT] is displayed.</p> <p>SDM-3R</p>  <p>The CHARGE LED blinks green. The BUMP and CAL LEDs both blink orange.</p> |

- 7 To check the expiration dates of the gas cylinders used, click [Cylinders] on the PC screen. (This step may be skipped during the bump test and calibration procedure.)

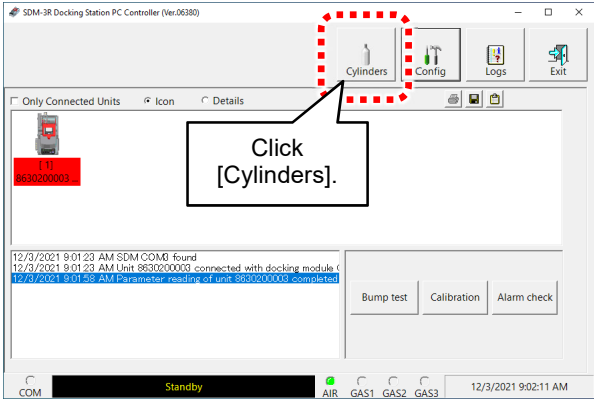
| PC screen | GX-3R |
|---|--|
|  | <p>—</p> <p>—</p> <p>SDM-3R</p> <p>—</p> <p>—</p> |

The names and expiration dates can be entered to check whether the cylinders in use are within their expiration periods.

* Select the [Active] checkbox manually.

- Expiration: Red: The expiration date has passed.
- Expiration: Orange: Less than ten days remain until the expiration date.
- Expiration: Orange: Ten days or more remain until the expiration date.

| No. | Name | Part No. | Expiration | Active |
|-----|---------------|--------------|------------|-------------------------------------|
| 1 | CH4 (50 %LEL) | 81-0012PK-01 | 12/1/2021 | <input type="checkbox"/> |
| 2 | CH4 (50 %LEL) | 81-0012PK-01 | 12/5/2021 | <input checked="" type="checkbox"/> |
| 3 | CH4 (50 %LEL) | 81-0012PK-01 | 3/22/2022 | <input type="checkbox"/> |
| 4 | | | | <input type="checkbox"/> |
| 5 | | | | <input type="checkbox"/> |
| 6 | | | | <input type="checkbox"/> |
| 7 | | | | <input type="checkbox"/> |
| 8 | | | | <input type="checkbox"/> |
| 9 | | | | <input type="checkbox"/> |
| 10 | | | | <input type="checkbox"/> |
| 11 | | | | <input type="checkbox"/> |
| 12 | | | | <input type="checkbox"/> |

- 8 To perform a bump test, click [Bump test] on the PC screen to display the GAS1 Selection screen.

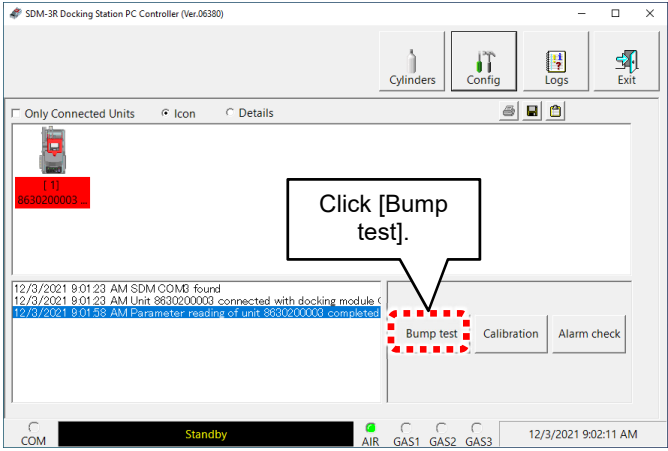
| PC screen | GX-3R |
|---|--------|
|  | — |
| — | — |
| — | SDM-3R |
| — | — |
| — | — |

- 9 On the GAS1 Selection screen, select the gas to be fed in via GAS 1, then click [OK].

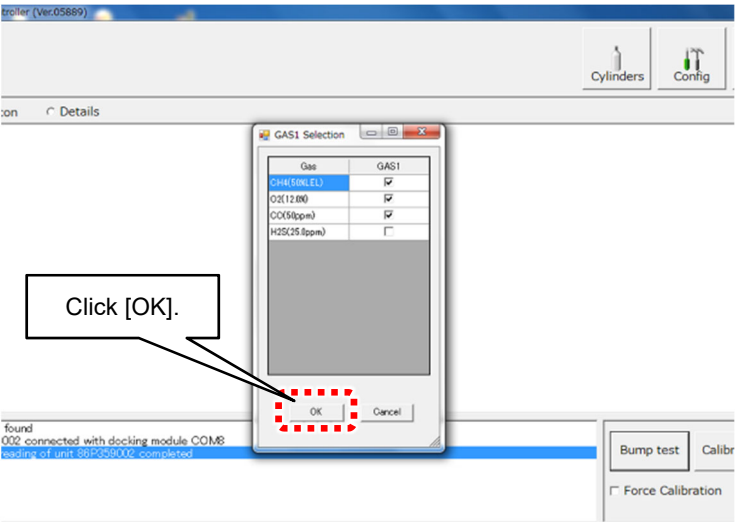
| PC screen | GX-3R |
|--|--------|
|  | — |
| — | — |
| — | SDM-3R |
| — | — |
| — | — |

- 10** The Gas order confirmation screen appears. If other gases are also to be used, select the checkboxes under [GAS2] and [GAS3] as necessary and select the corresponding gases.

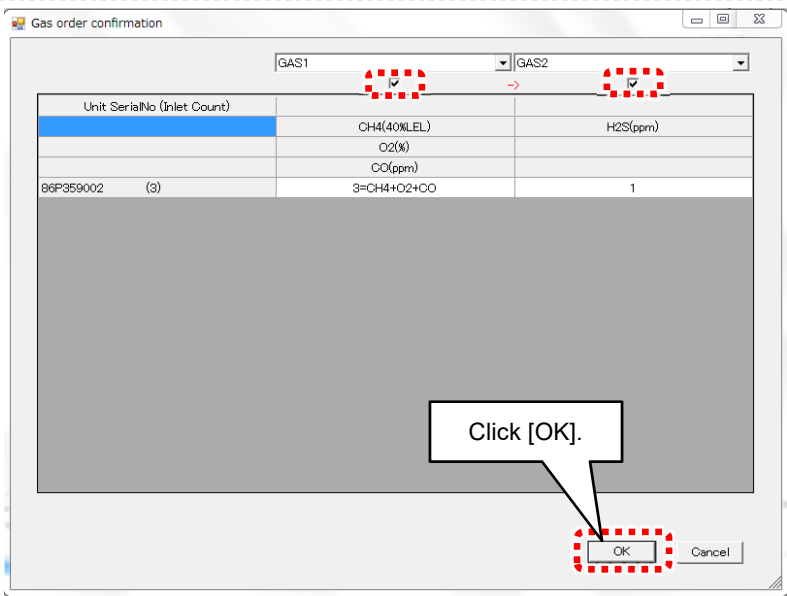
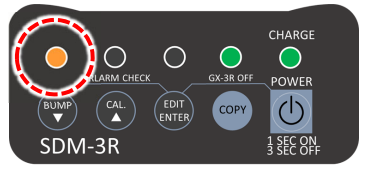
| PC screen | GX-3R |
|---|--|
|  | <p style="background-color: #cccccc; padding: 5px;">GX-3R</p> <p style="text-align: center;">—</p> <p style="text-align: center;">—</p> <p style="background-color: #cccccc; padding: 5px;">SDM-3R</p>  |
| <p>Clicking [OK] on the PC screen displays a confirmation window. Click [OK] here too to start the bump test.</p> | <p>The BUMP LED blinks orange.</p> |

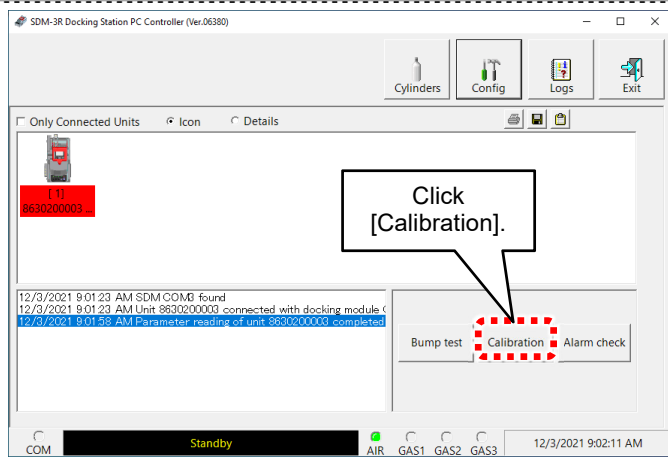

- 11** To perform calibration, click [Calibration] on the PC screen to display the GAS1 Selection screen.

| PC screen | GX-3R |
|---|--|
|  | <p style="background-color: #cccccc; padding: 5px;">GX-3R</p> <p style="text-align: center;">—</p> <p style="text-align: center;">—</p> <p style="background-color: #cccccc; padding: 5px;">SDM-3R</p> <p style="text-align: center;">—</p> <p style="text-align: center;">—</p> |

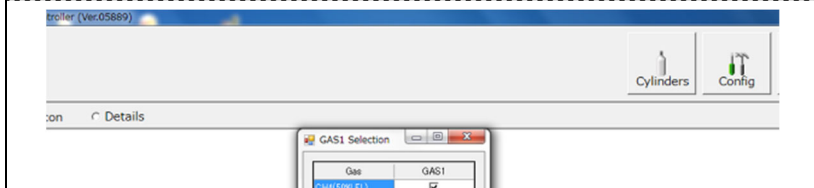
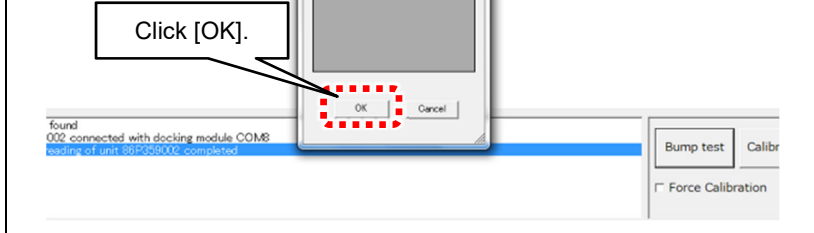
- 12** On the GAS1 Selection screen, select the gas to be fed in via GAS 1, then click [OK].

| PC screen | GX-3R |
|--|--------|
|  | — |
| — | — |
| — | SDM-3R |
|  | — |
| — | — |

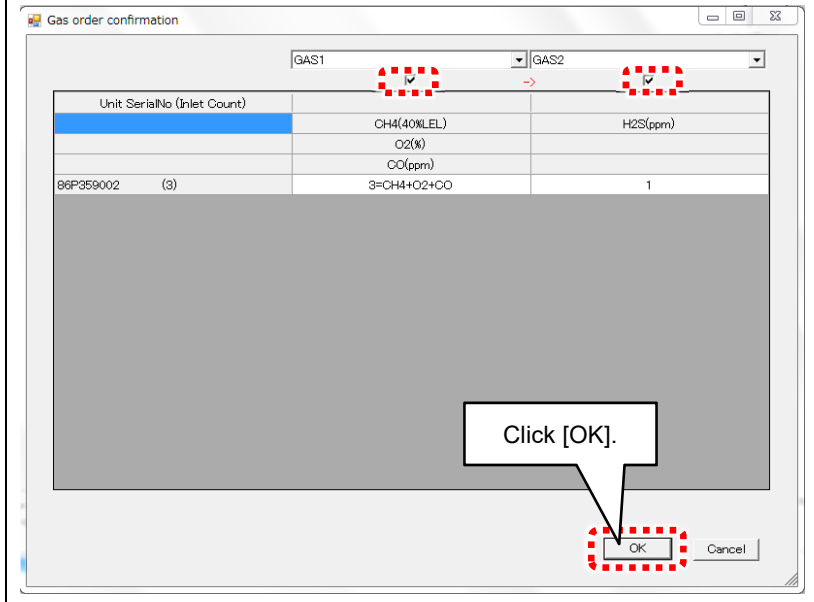
- 13** The Gas order confirmation screen appears. If other gases are also to be used, select the checkboxes under [GAS2] and [GAS3] as necessary and select the corresponding gases.

| PC screen | GX-3R |
|---|---|
|  | — |
| — | — |
| — | SDM-3R |
|  |  |
| <p>Clicking [OK] on the PC screen displays a confirmation window. Click [OK] here too to start calibration.</p> | <p>The CAL LED blinks orange.</p> |

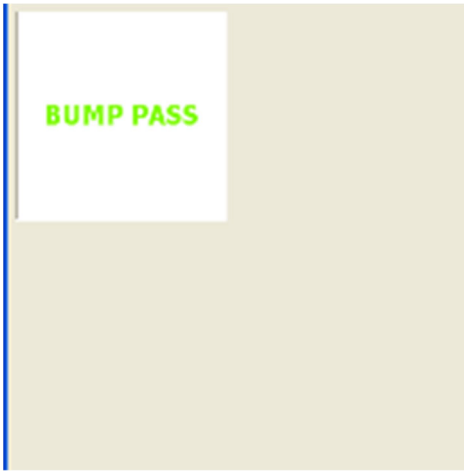
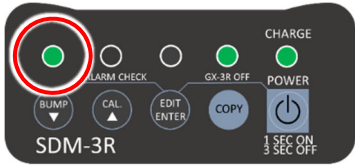

14 The results are displayed. (Bump test)

| PC screen | GX-3R |
|---|---|
|  | <div style="text-align: center;">  </div> |
| <p>[BUMP PASS] is displayed if all bump tests were successful.</p> | <p>The BUMP LED lights up green if all bump tests were successful. * The LED lights up red if even one bump test failed.</p> |

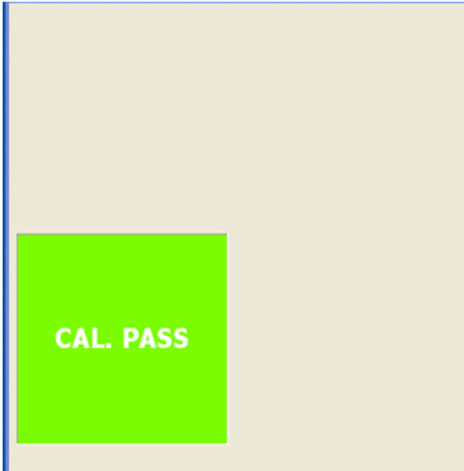
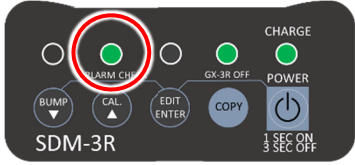

15 The results are displayed. (Calibration)

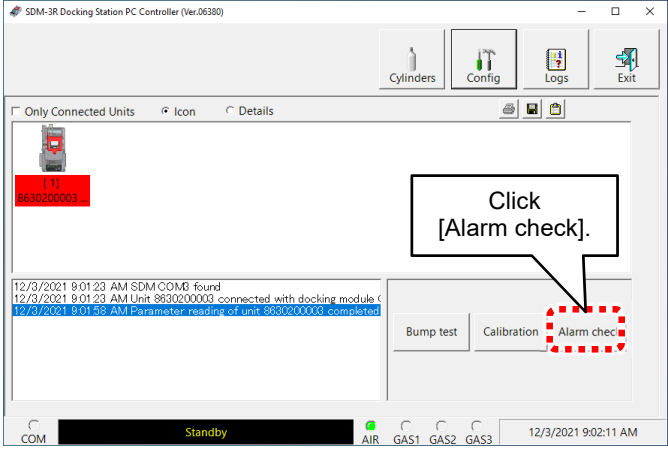
| PC screen | GX-3R |
|---|--|
|  | <div style="text-align: center;">  </div> |
| <p>[CAL. PASS] is displayed if all calibrations were successful.</p> | <p>The CAL LED lights up green if all calibrations were successful. * The LED lights up red if even one calibration failed.</p> |

- 16** When performing an alarm test, click [Alarm check] to display a confirmation window. Click [OK] here.

| PC screen | GX-3R |
|---|--|
|  | <p data-bbox="1203 271 1286 300">GX-3R</p> <p data-bbox="1190 510 1299 539">SDM-3R</p>  |
| <p data-bbox="240 815 496 844">The alarm test starts.</p> | <p data-bbox="1058 797 1410 857">The EDIT/ENTER LED blinks orange.</p> |

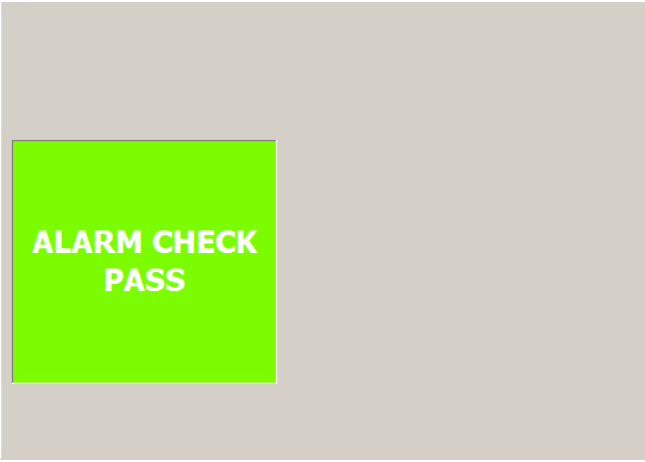
- 17** Once the alarm test ends, the result screen is displayed, and the product LED changes from blinking orange to green.

| PC screen | GX-3R |
|---|---|
|  | <p data-bbox="1203 1016 1286 1046">GX-3R</p> <p data-bbox="1058 1207 1399 1296">The LED next to the screen and the entire alarm window light up in red.</p> <p data-bbox="1190 1323 1299 1352">SDM-3R</p>  |
| <p data-bbox="240 1619 954 1675">[ALARM CHECK PASS] is displayed if the alarm check was successful.</p> | <p data-bbox="1058 1570 1410 1659">The EDIT/ENTER LED lights up green if the alarm check was successful.</p> <p data-bbox="1058 1659 1410 1715">* The LED lights up red if the alarm check failed.</p> |

3-6-2. Creating a calibration certificate

Procedure

PC screen display

- 1 Turn on the product, then connect to the PC.
- 2 Once the PC is connected, click [Logs] on the screen.

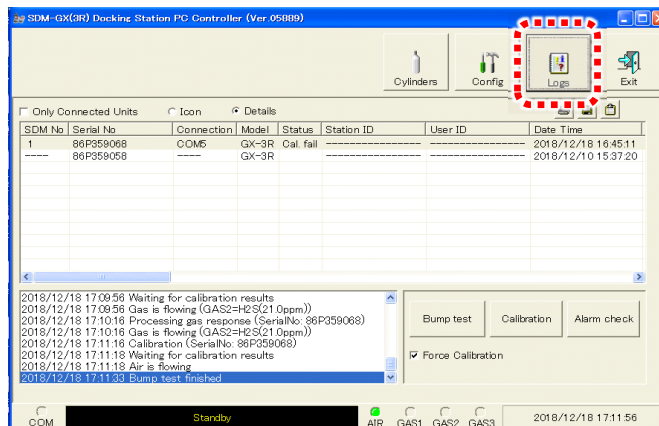

- 3 On the PC screen, click the model number for the gas monitor (sold separately) for which a report is to be created.

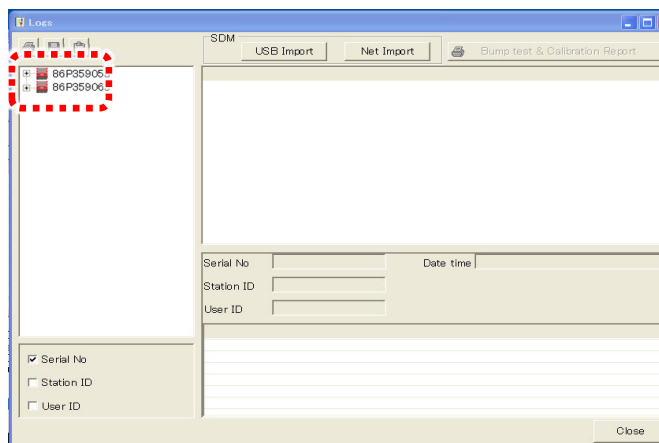

- 4 On the PC screen, click the items ([Calibration], [Bump test], [Alarm check]) to be included in the report

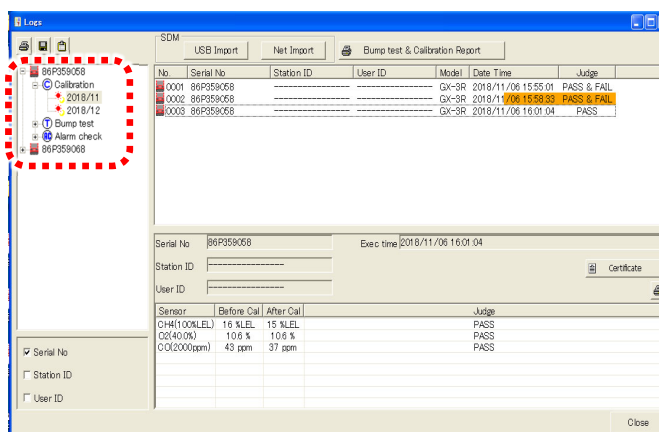

- 5** Click the dates for the items to be included in the report.
Displays the details of operations performed on that date.

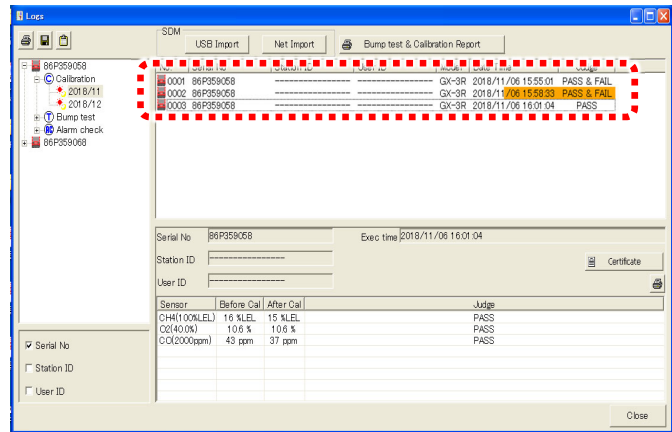

- 6** Select the details of operations performed on that date, then click [Certificate].

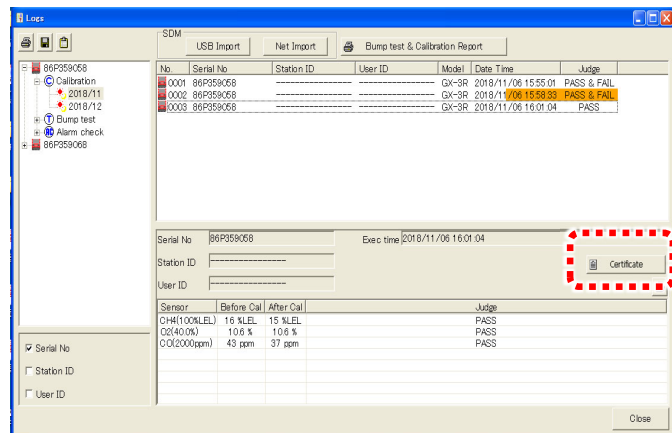

- 7** Check the details, then select the language (English, Portuguese, Japanese). Click the printer icon to print using the printer set as [Default] in Windows.

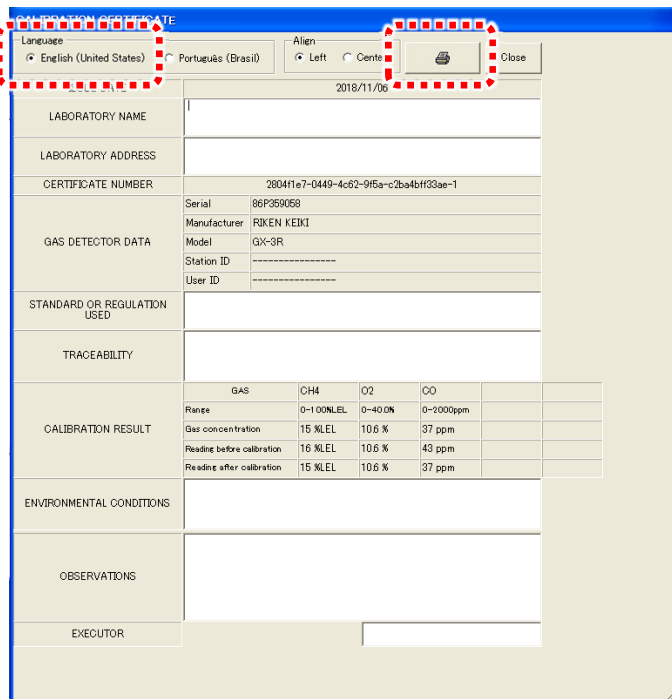

3-7. Turning off the power

NOTE

- The power can be turned off only when the product is not communicating with the gas monitor (sold separately).
- The power for the gas monitor (sold separately) can be turned off as follows:
<When operating the buttons on the product (independently)>
With the main screen or test result screen displayed, hold down the POWER button and EDIT/ENTER button together on the product for three seconds to turn off the power for the gas monitor (sold separately).
The power for the gas monitor (sold separately) also turns off automatically if no buttons are operated for more than ten minutes with the main screen or test result screen displayed.

<When using the PC Controller Program (optional)>

Right-click the gas monitor (sold separately) icon in the PC Controller Program (optional), then select [Power off] to turn off the power for the gas monitor (sold separately).

The power for the gas monitor (sold separately) also turns off automatically if no operation is performed on the main screen for one hour.

Hold down the POWER button on the product for three seconds to turn off the power for the product.

Storage and Disposal

4-1. Procedures for storage or when not in use for extended periods

The product must be stored in the following environment:

- At normal temperature and humidity in a location not exposed to direct sunlight
- In a location free of gases, solvents, and vapors

Store the product in its shipping carton if this has been retained.

If the shipping carton is not available, store away from dust and dirt.

4-2. Product disposal

Dispose of the product as industrial waste (incombustible) in accordance with local regulations.

5

Troubleshooting

This troubleshooting chapter does not cover the causes of all possible product malfunctions. It provides brief explanations to assist in determining the causes of common problems. If you encounter symptoms not addressed here or if problems persist even after taking corrective action, contact Riken Keiki.

| Symptom <Display> | Cause | Action |
|----------------------------------|---|--|
| The power cannot be turned on. | The AC power supply is not correctly connected or the AC power supply voltage is below the stipulated rating. | Check the AC power supply socket connection. Check to confirm that the AC adapter is correctly connected to the product. If no problem is identified, contact Riken Keiki. |
| | The POWER button was pressed for too short or too long a time. | To turn on the power, hold down the POWER button until the buzzer blips, then release the button. |
| | The battery compartment cover is not closed completely. | Close the battery compartment cover completely. |
| Abnormal operation | Effects of sudden static electricity noise, etc. | Turn off the power, then turn it back on again. |
| Air calibration is not possible. | Fresh air is not being supplied around the product. | Provide fresh air. |
| | The sensor sensitivity has degraded. | Contact Riken Keiki to request sensor replacement. |
| Low flow rate alarm indication | Water or oil has been aspirated into the interior. | Check the gas sampling tube to confirm it is not damaged and that no oil or water has been sucked in. |
| | The filter is clogged. | Check the filter mounting condition and whether it is clogged or twisted. |
| | The pump is deteriorated. | Contact Riken Keiki to request pump replacement. |
| | Stored for extended periods out of use (six months or more). | If a low flow rate error is displayed, turn off the power, then turn it back on again (restart). If the problem persists even after repeating this process several times, contact Riken Keiki to request pump replacement. |

| Symptom <Display> | Cause | Action |
|---|--|--|
| Calibration is not possible. A calibration error occurs. | The calibration gas is not connected correctly to the gas inlet. | Check to confirm that the filter is fitted correctly. |
| | The gas outlet is blocked. | Check to confirm that the gas outlet piping is not blocked. If no problem is identified, contact Riken Keiki. |
| AUTO CAL is not possible. An error occurs. | The concentration of the calibration gas used does not match the AUTO CAL calibration gas concentration. | Set the gas concentration for AUTO CAL on the gas monitor (sold separately) to match the calibration gas used. * This can be set only on the gas monitor (sold separately). |
| Alarm check fails. | An error occurred in the alarm display of the detector that fails in alarm check. | Remove the gas monitor from the product, then check the alarm operation of the detector on its own. If no problem is identified, contact Riken Keiki. |
| Charging error | The temperature is outside the permissible charging temperature range. | Allow the product to fully adjust to temperatures within the operating temperature range before recharging. |

Product Specifications

6-1. Specifications list

| | |
|--------------------------------------|--|
| Model | SDM-3R |
| Compatible gas monitors | GX-3R, GX-3R Pro |
| Input power supply | Main unit input: 6 V DC / Accessory AC adapter input: 100 - 240 V AC |
| Memory capacity | 150 KB |
| Maximum data storage capacity | Up to 200 items (bump test, calibration, alarm check) |
| Operating temperature range | 0 to +40 °C (no sudden fluctuations) |
| Operating humidity range | 0 - 95 %RH (no condensation) |
| External dimensions | Approx. 130 mm (W) × 100 mm (H) × 250 mm (D) (excluding projections) |
| Weight | Approx. 800 g |

6-2. Accessory list

Accessories

| Part name | Part No. |
|---------------------------|--------------|
| Cylindrical filter | 4383 69 |
| Tube (approx. 40 mm) | 4395 4424 80 |
| AC adapter | 2594 0898 30 |
| Cross recessed head screw | 1955 1415 60 |

Optional accessories

| Part name | Part No. |
|---------------------------------------|--------------|
| Connecting fixture | 4395 9166 40 |
| Wall mounting fixture | 4395 9165 70 |
| Exhaust tube (2 m) | 4395 4442 10 |
| Exhaust tube (5 m) | 4395 4444 60 |
| AV jack cap (for LAN connector) | 0800 0941 50 |
| USB connector cap | 0800 0942 20 |
| AU plug | 2594 0932 90 |
| EU plug | 2594 0933 60 |
| UK plug | 2594 0934 30 |
| USB flash drive | 2594 1084 30 |
| USB cable | 2440 1702 00 |
| LAN cable | 2594 1081 00 |
| PC Controller Program (SW-SDM-3R(EX)) | 9811 92 |

Revision history

| Issue | Revision | Issue date |
|-------|--|------------|
| 0 | First issue | 2019/3/15 |
| 1 | Correct 7.8 and 9.2, Declaration of Conformity added | 2019/7/29 |
| 2 | Declaration of Conformity | 2020/4/1 |
| 3 | Declaration of Conformity | 2021/11/9 |
| 4 | Complete revision (PT0-1674) | 2022/1/25 |
| 5 | Correction 「3-4.Settings」 | 2022/5/17 |
| 6 | Correction : CE Declaration of Conformity, Addition : 1-4 Method of confirmation for CE/UKCA marking type UKCA Declaration of Conformity | 2022/7/11 |
| 7 | Correction : CE Declaration of Conformity | 2024/5/31 |



EU-Declaration of Conformity

Document No. 320CE24031



We, RIKEN KEIKI Co., Ltd. 2-7-6, Azusawa, Itabashi-ku, Tokyo, 174-8744, Japan declare under our sole responsibility that the following product conforms to all the relevant provisions.

Product Name Docking Station
Model SDM-3R

| Council Directives | Applicable Standards |
|---|--|
| EMC Directive (2014/30/EU) | EN 61000-6-4:2007+A1:2011 EN 61000-6-2:2005 |
| BATTERY Regulation ((EU)2023/1542) | - |
| RoHS Directive (2011/65/EU ^[1]) | EN IEC 63000:2018 |

^[1]Including substances added by Commission Delegated Directive (EU) 2015/863

Place: Tokyo, Japan

Date: May. 24, 2024

Takakura Toshiyuki
General manager
Quality Control Center



UK-Declaration of Conformity

Document No.: 320UK22018



We, RIKEN KEIKI Co., Ltd. 2-7-6, Azusawa, Itabashi-ku, Tokyo, 174-8744 Japan declare under our sole responsibility that the following product conforms to all the relevant provisions.

Product Name: Docking Station
Model: SDM-3R

| Regulations | UK designated Standards |
|---|---|
| Electromagnetic Compatibility Regulations 2016 (S.I. 2016/1091) | BS EN 61000-6-4:2007 +A1:2011 BS EN 61000-6-2:2005 |
| The Restriction of the Use of Certain Hazardous Substances in Electrical and Electronic Equipment Regulations 2012 (S.I. 2012/3032) | BS EN IEC 63000:2018 |

Place: Tokyo, Japan

Date: May. 27, 2022

Takakura Toshiyuki
General manager
Quality Control Center