



Gas Detector
70D Series Ethernet Model
System Construction Manual

RIKEN KEIKI Co., Ltd.

2-7-6 Azusawa Itabashi-Ku, Tokyo, 174-8744, Japan

Website: <http://www.rikenkeiki.co.jp/>

Contents

1. Introduction	
1-1. Procedures for laying Ethernet communication line	2
2. Important safety information	
2-1. DANGER, WARNING, CAUTION, and NOTE	3
2-2. Warnings	3
3. Ethernet communication line configuration and specifications	
3-1. Overview of communication line configurations	4
4. Model selection	
4-1. Device and cable selection	5
5. System construction	
5-1. Important information on design and cabling	6
5-2. LAN cable termination	8
5-3. Gas detector installation and wiring	9
6. Testing and measurement	
6-1. Measurement and testing after cabling	16
6-2. Communication test for entire network	16
7. Maintenance	
7-1. Maintenance intervals and inspection items	17
7-2. Securing spare parts for emergency response	17
Appendices	18
Appendix 1. Checklist for configuration design	19
Appendix 2. System construction checklist	19
Appendix 3. Communication failure checklist	20
Appendix 4. List of measuring instruments and tools	21
Appendix 5. Description of terms	22

1. Introduction

This document has been prepared to help you configure a system with the Ethernet Gas Detector (GD-70D-EA) and Signal Converter (SD-70SC-EA).

This document describes information required for system construction, including the procedures and check items required to ensure trouble-free design and construction and to prevent problems on start-up. We recommend that both experienced users and users new to the product read this document thoroughly to ensure the required product knowledge, familiarity, and understanding before proceeding with design and construction.

Additionally, refer to the separately provided "GD-70D Series Operating Manual" for information on using the gas detector and the separately provided "GD-70D-ET Communication Function Manual" for information on settings related to communication data.

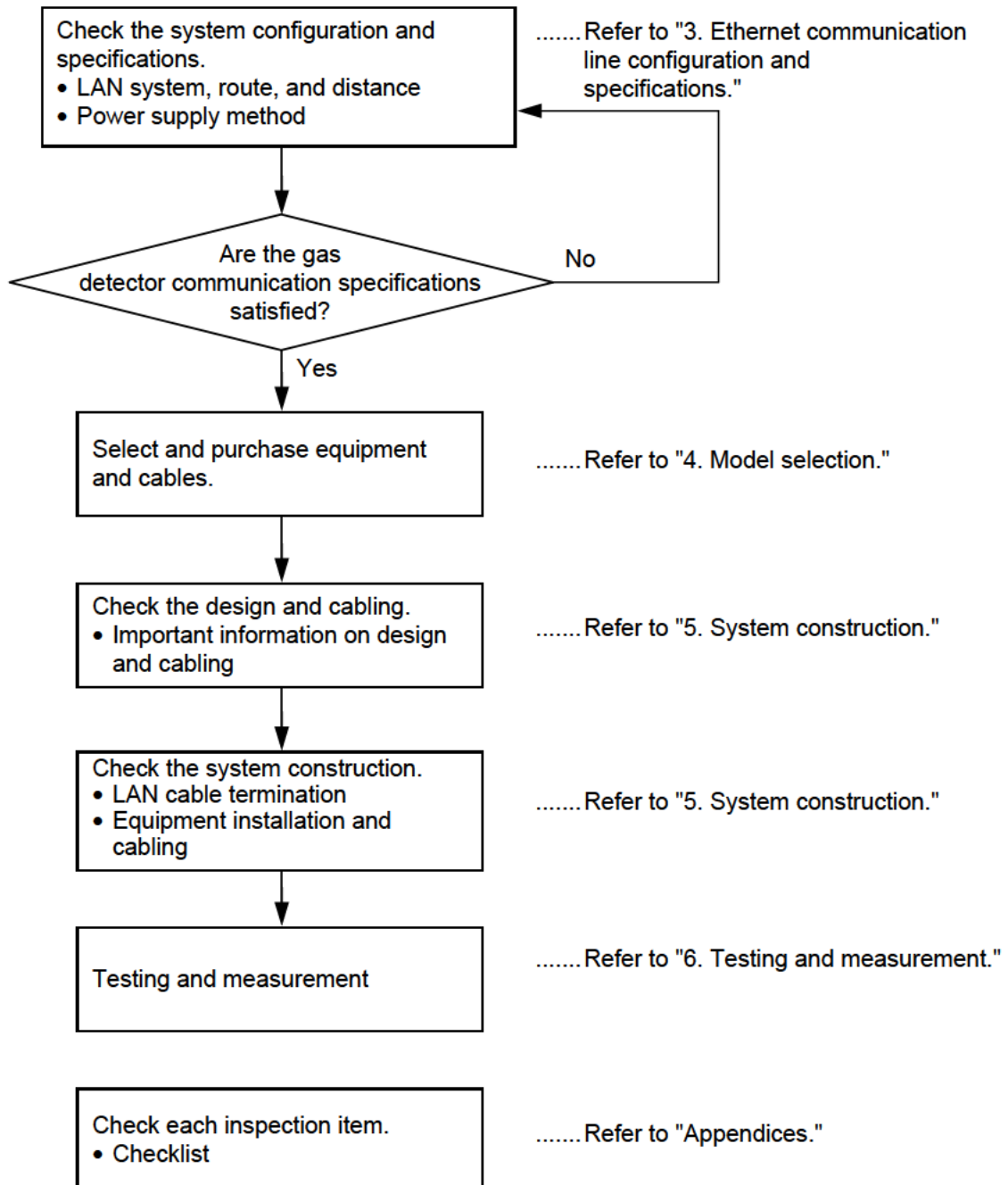

1-1. Procedures for laying Ethernet communication line

This manual is organized as follows:



2. Important safety information

2-1. DANGER, WARNING, CAUTION, and NOTE

 DANGER	The DANGER sign indicates that improper handling of the product may result in death, severe injury, or serious property damage.
 WARNING	The WARNING sign indicates that improper handling of the product may result in severe injury or serious property damage.
 CAUTION	The CAUTION sign indicates that improper handling of the product may result in minor injury or minor property damage.
* NOTE	The NOTE sign indicates recommendations for product handling.

2-2. Warnings

 WARNING
<p>Power source Before turning on power for the product, be sure to confirm that the power source meets the specified voltage requirements. Avoid using unstable power sources; doing so may lead to malfunctions.</p>
<p>Protective grounding required Do not cut the protective grounding line of the product or disconnect the protective grounding terminal.</p>
<p>Defects involving protective functions Before operating the product, check the protective functions for defects. Do not operate the product if you find potential defects in protective functions, including protective grounding.</p>
<p>External connections Be sure to provide secure protective grounding before connecting the product to the detection target or external control circuit.</p>

3. Ethernet communication line configuration and specifications

3-1. Overview of communication line configurations

Roughly speaking, communication lines for this product can be configured in two ways. When choosing between the two, follow the instructions of the person in charge of system design.

PoE system

The LAN cable is used for both communications and power supply.
(With PoE HUB)

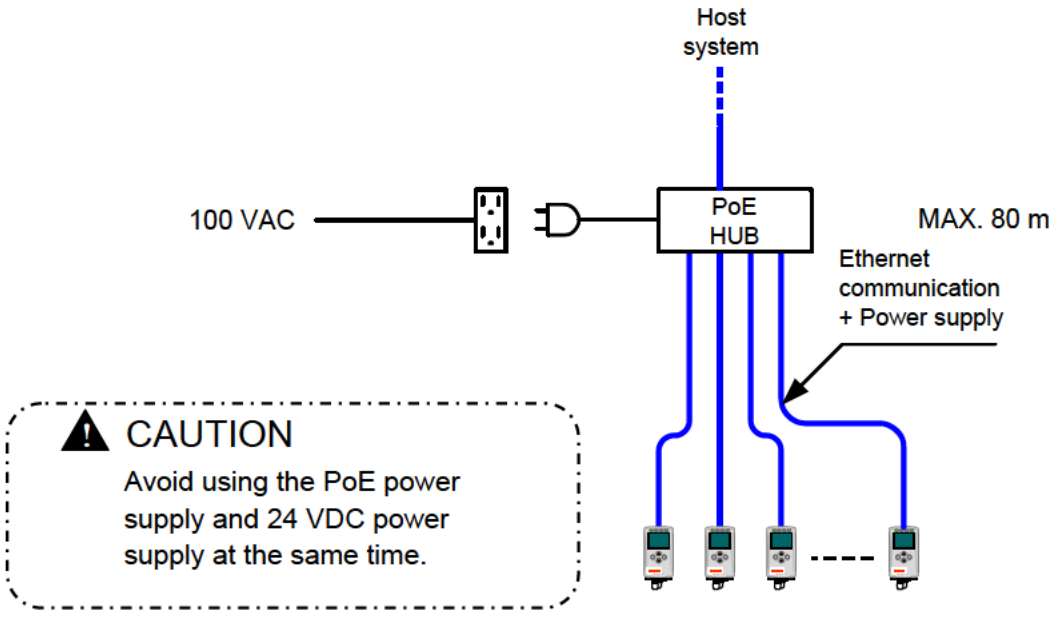

Ethernet system

The Ethernet system requires a LAN cable and a 24 VDC power cable.

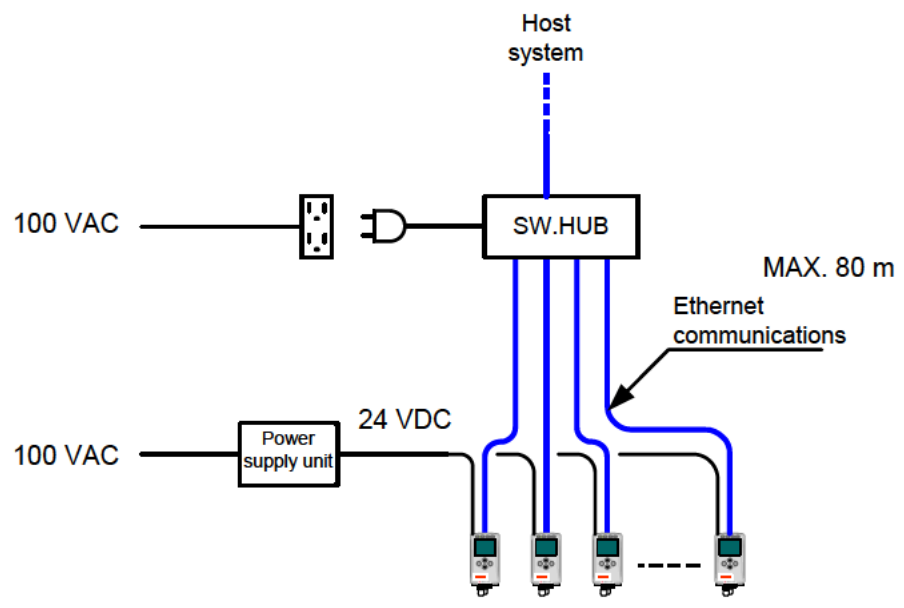

4. Model selection

4-1. Device and cable selection

PoE HUB (if the system selected is PoE)

Item	Description
Power source	PoE power supply (PoE standard-compliant) <ul style="list-style-type: none"> • PoE: IEEE 802.3af (1 port, MAX. 15.4 W) • PoE+: IEEE 802.3at (1 port, MAX. 30 W)
Power supply capacity	<p style="text-align: center;">* NOTE</p> <p>Depending on the model, due to product specifications, even if the supply capacity per port is sufficient, connecting all ports at the same time may result in inadequate maximum supply capacity. Select a model capable of providing the capacity needed or restrict the number of connected detectors.</p> <p>[Reference] Number of connected gas detectors x 8 W (MAX.) ≤ Total power supply capacity Power consumption per gas detector = 6 W to 8 W The specifics will differ depending on the sensor unit. Refer to the separate specification sheet for more information.</p>

HUB (PoE/Ethernet common specifications)

Item	Description
Power cable loosening prevention	Model incorporating features to keep the power cable from coming off the HUB main body (Cable loosening prevention fitting)





LAN cable

Item	Description
Cable used	UTP (Unshielded twisted pair) cable <p style="text-align: center;">* NOTE</p> <p>If you select an STP (shielded twisted pair) cable, the shield will not be grounded unless the connected device (HUB) also supports STP. If this requirement is not met, problems with noise will be even more pronounced. For this reason, we recommend using a UTP cable.</p>
Standard	Category 5 or 5e
Supported medium	100BASE-TX or better
Cable specifications	Solid wire cable (up to 5 m for stranded wire cable)
Modular plug	RJ-45
Number of cores	8
Wire connection	Straight-through connection

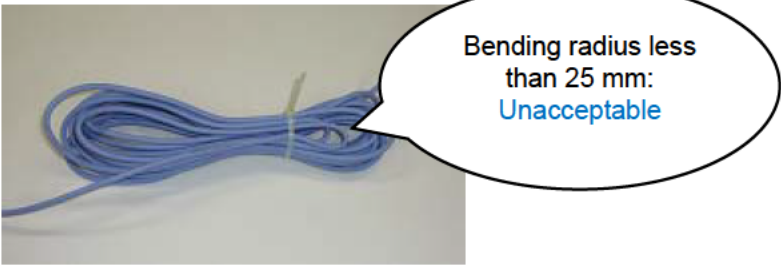
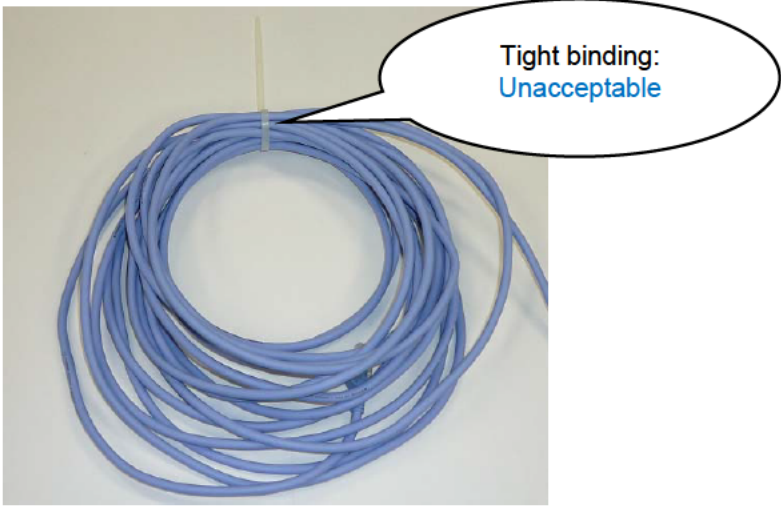

5. System construction

5-1. Important information on design and cabling

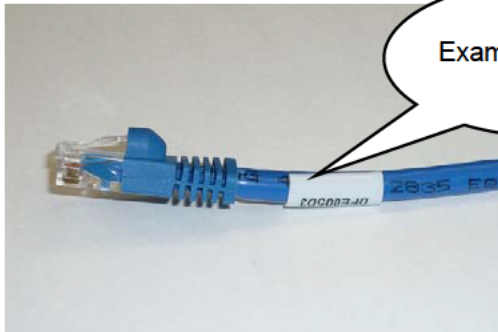
No.	Item	Description
1	Power supply capacity of PoE HUB	Due to specifications, even if the supply capacity per port is sufficient, some ports may be unusable because overall capacity is inadequate. In designing the system, take steps to secure the power supply capacity needed.
2	LAN cable Tension	Avoid pulling the cable too tightly. Lay loosely. The specified maximum tension of the UTP cable is 9.3 kg (110 N). Pulling on the cable with more force will elongate and attenuate the core conductors and deform the core insulator, reducing spacing between the conductors, increasing return losses, and possibly impairing communications.
3	LAN cable Bending	The bending radius must be 25 mm or greater. Folding the cable may deform the strands of twisted pair wires inside, increasing return losses and impairing communications. 
4	LAN cable Binding	Do not bind the cable tightly with cable ties or similar materials. Binding the cable tightly may compress the twisted pair wires inside the cable, increasing return losses and impairing communications. 
5	LAN cable Cabling	Do not lay the cables in perfect parallel over extended distances. When laying the cables in parallel, arrange somewhat randomly. Crosstalk from cables laid in parallel over extended distances may cause errors in data communications.

No.	Item	Description
6	Anti-noise measures	<p>To prevent or reduce noise interference, install the cables as far from noise sources as possible.</p> <p>Use racks dedicated for communication to isolate the cables as much as possible.</p> <p>[Reference]</p> <ul style="list-style-type: none"> • From transformers and motors: 120 cm or more • From AC power cables: 30 cm or more • From fluorescent lamps: 13 cm or more
7	LAN cable Handling excess lengths of cable	<p>Avoid rolling cables into neat circles of the same diameter. As with parallel cabling over extended distances (described in No. 5 on the previous page), doing so may cause errors in data communications. When rolling the cable in circles, vary the diameters of the circles somewhat randomly.</p> <div style="display: flex; justify-content: space-around; align-items: center;"> <div style="text-align: center;">  <p>Neat circles: Unacceptable</p> </div> <div style="text-align: center;">  <p>Random circles: Acceptable</p> </div> </div>
8	LAN cable Length	<p>MAX. 80 m</p> <p>The theoretical maximum length is 100 m. However, considering the increase in the conductor resistance at high temperatures, limit to 80 m.</p>
9	Modular cover	<p>Select a cover that completely covers the latching tab of the LAN cable end.</p> <p>If the system is installed in the field, the latching tabs may fail when the cable is subjected to a sudden force. This will result in an easily disconnected cable and may activate communication error alarms.</p> <div style="display: flex; justify-content: space-around; align-items: center;"> <div style="text-align: center;">  <p>Latching tab uncovered: Unacceptable</p> </div> <div style="text-align: center;">  <p>Latching tab covered: Acceptable</p> </div> </div>
10	LAN cable Marking	<p>Mark both ends of the cable to enable management.</p> <p>Example: Gas detector tag number</p> <div style="text-align: center;">  <p>Example of marking</p> </div>

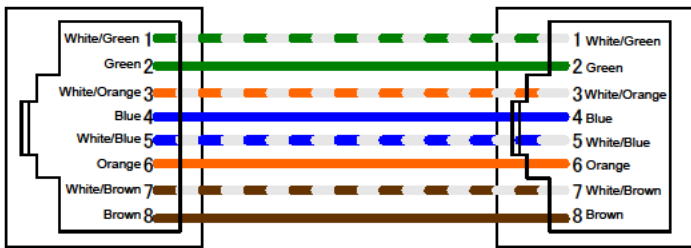
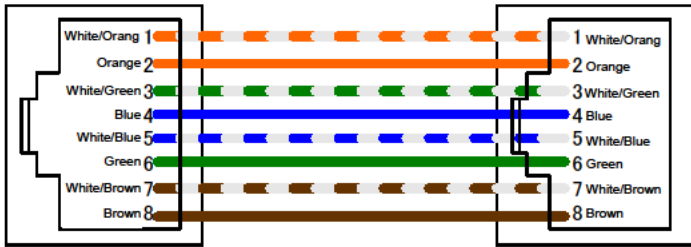
5-2. LAN cable termination

Item	Description
Crimping tool Connector manufacturer	The actual structure of the RJ-45 connector may differ slightly, depending on the manufacturer. We recommend processing terminals with the crimping tool recommended by the manufacturer.
RJ-45 Modular plug	Avoid using plugs for stranded wire with solid wire cables. Avoid using the same plugs for solid wire and stranded wire.
Wire connection	<p data-bbox="518 459 869 488">Straight-through connection</p> <p data-bbox="518 492 1391 560">Connect wires in compliance with T-568A (both ends) or T-568B (both ends).</p> <div data-bbox="518 571 630 604" style="border: 1px solid black; padding: 2px; display: inline-block;">T-568A</div>  <div data-bbox="518 918 630 952" style="border: 1px solid black; padding: 2px; display: inline-block;">T-568B</div>  <div data-bbox="518 1265 726 1299" style="border: 1px solid black; padding: 2px; display: inline-block;">Pin assignment</div> 

5-3. Gas detector installation and wiring

1) Removing and attaching the main unit

Removing the main unit

Press the pale-blue lever to the side of the wall-mounted unit and lift the main unit while continuing to press on the lever.

If you cannot lift the main unit, insert a large flathead screwdriver as shown in the figure below while pressing on the lever. The unit should come loose easily. Simply insert the flathead screwdriver into the wall-mounted unit; avoid rotating or moving up and down.

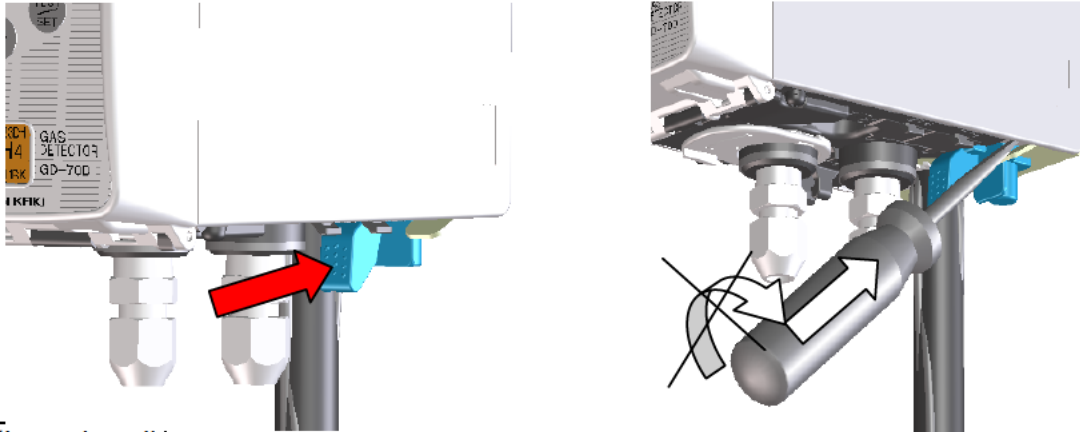

Attaching the main unit

Position the main unit 10 mm above the wall-mounted unit and press the main unit against the wall-mounted unit. Make sure the claws on both sides of the wall-mounted unit fit the groove of the main unit.

Next, press down on the main unit to secure into place. When the main unit is correctly secured, the lock at the bottom of the main unit will click and lock into place. Confirm that the upper central part of the wall-mounted unit protrudes above the main unit when viewed from the front.

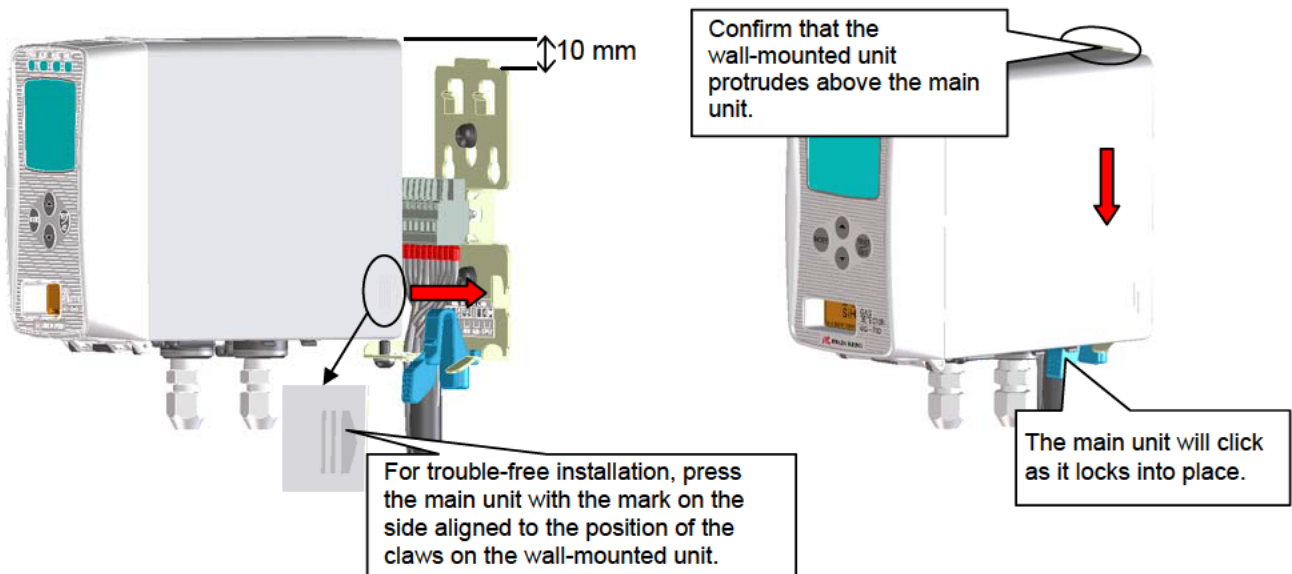

CAUTION

- Be careful to avoid dropping the main unit during removal. When attaching the main unit to the wall-mounted unit, confirm that it is attached securely. If it is not attached securely, the main unit may fall and result in unexpected injuries or damage to the devices.
- Remove and attach the main unit with the power turned OFF.

2) Installation

⚠ CAUTION

Before installing the product, remove the protective rubber caps attached to the GAS IN and GAS OUT ports. Installing the product with the rubber caps attached and turning ON power in this state will impose excess loads on the pump and sensor and may result in damage. Be sure to remove the caps.

<Mounting dimensions and maintenance space>

Secure the hatched areas as the mounting space before installing the product.

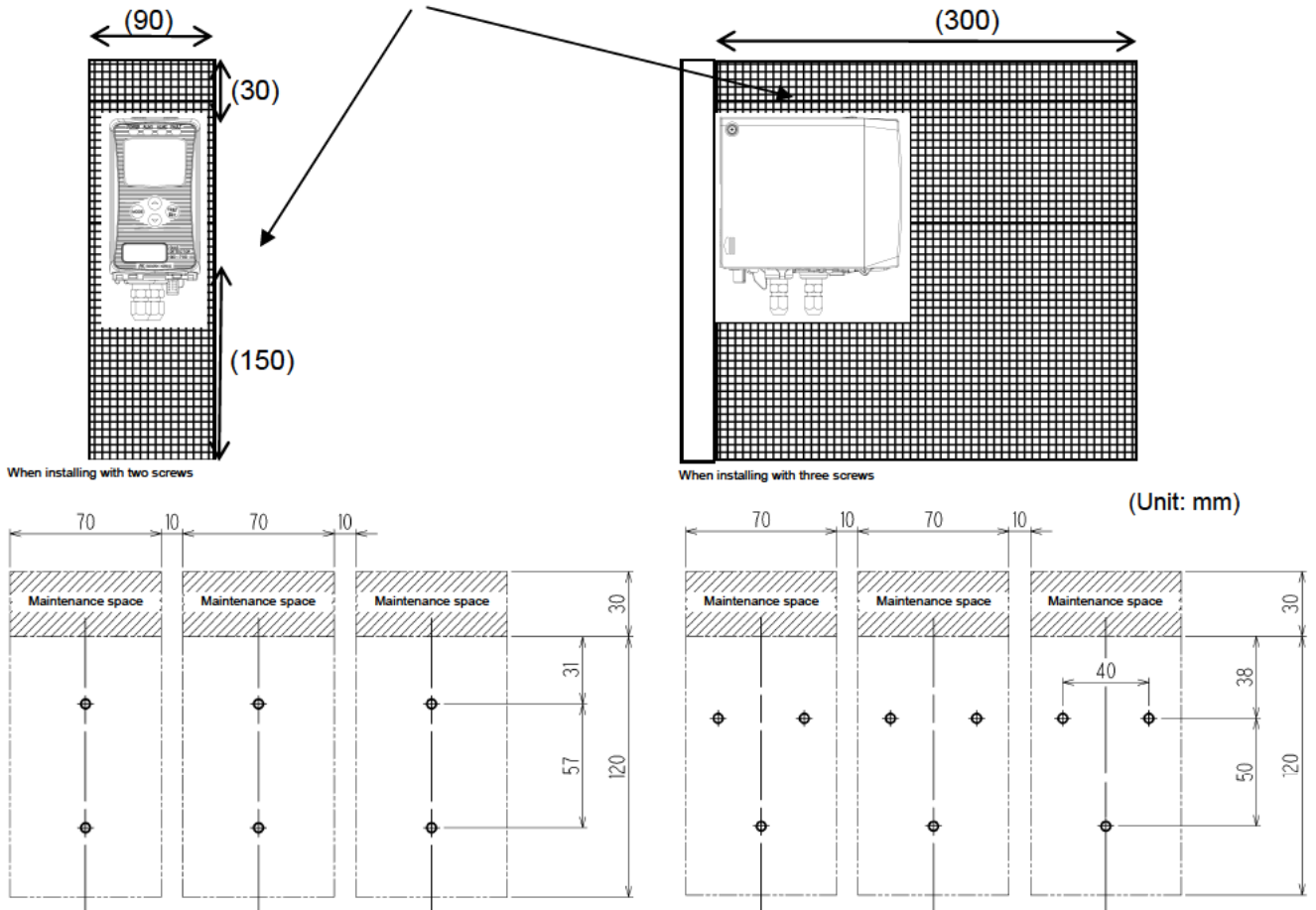

⚠ CAUTION

- We recommend leaving at least 10 mm for the installation pitch. The minimum is 5 mm.
- When installing two or more detectors side by side, install on a rack or wall free of vibrations. If the rack or wall on which the detectors are installed lacks sufficient strength, installing side by side may result in resonance between the devices due to the vibration of the built-in pump. If so, take appropriate measures like reinforcing the rack or wall.

⚠ CAUTION

This product has specific installation directions for reasons related to performance. Install according to the example shown in the figure below and make sure the product is level. (*The same directions apply for carrying the product. Be careful even with temporary removal and relocation.)

<Correct installation direction>

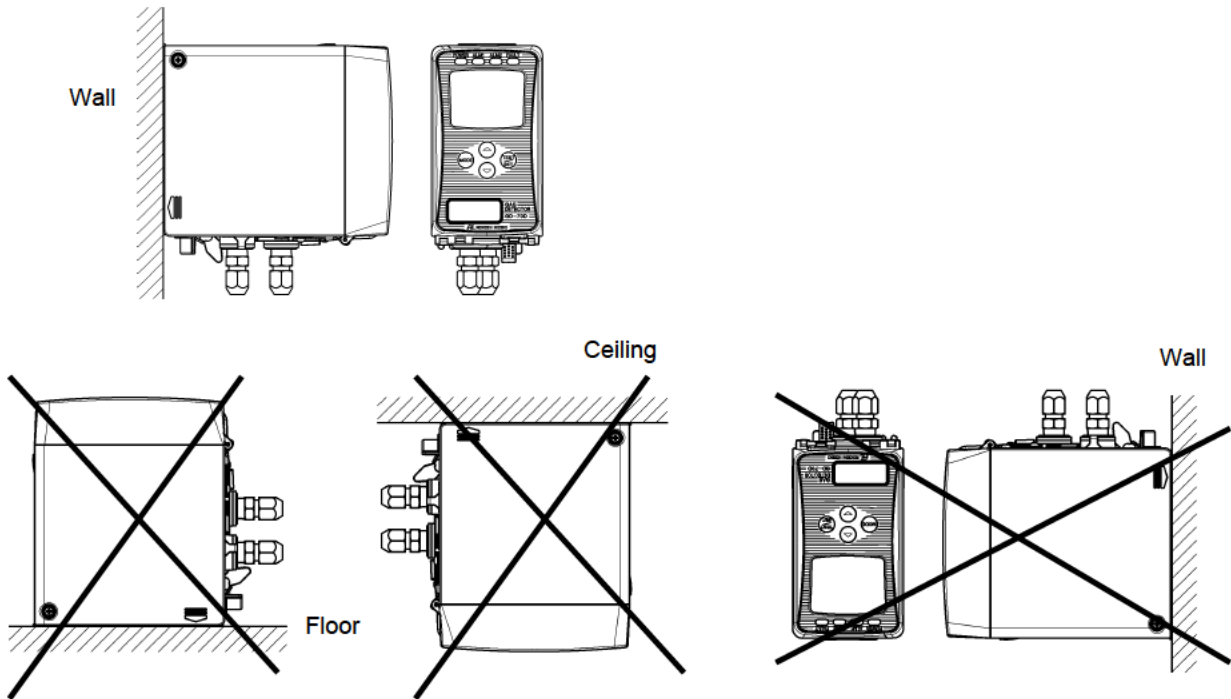

<Installing the wall-mounted unit>

Secure the wall-mounted unit to the installation surface with two or three M5 screws.

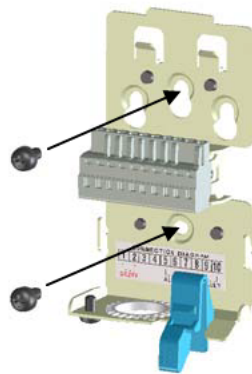

Recommended attachment screw (M5)
Length: 8 mm or longer
The flat washer must be φ10 mm or less.

After installing the wall-mounted unit on the wall, attach the main unit to the wall-mounted unit.

⚠ CAUTION

Install the wall-mounted unit so that no gap remains between the wall-mounted unit and the installation surface. A gap may result in unnecessary vibrations and noise.

3) Wiring

⚠ CAUTION

- During wiring work, be careful to avoid damaging the internal electronic circuits. Also, avoid excess cable weights or cable routing that may impose excessive stress.
- Do not route the power cable and signal cable alongside power lines for motors or similar equipment. If you must lay the cables in parallel, pass the power cable and the signal cable through a metal conduit. Be sure to ground the conduit.
- When using stranded wire cables, make sure no part of the core wires contacts other core wires.
- For wiring work, use the dedicated operating lever.

<Recommended cable>

Separate power supply (Ethernet)	Power supply: Cable such as CVV (1.25 sq.), 2 cores
For contact	Cable such as CVV (1.25 sq.), up to 6 cores

<Terminal plate diagram>

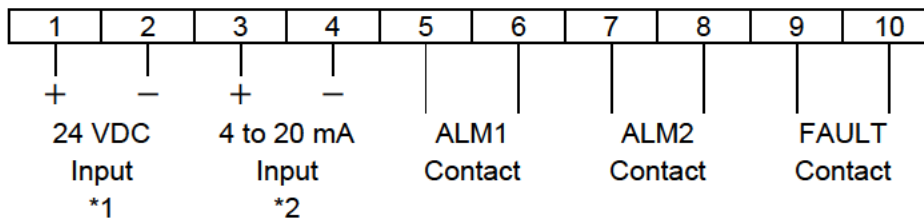

* NOTE

- *1: Incompatible with PoE system
- *2: Signal input at 4 mA to 20 mA for the signal converter (SD-70SC-ET) (Refer to the separate operating manual.)

<Terminal plate specifications>

Terminal plate specifications

- Rated voltage: 250 VAC
- Rated current: 16 A

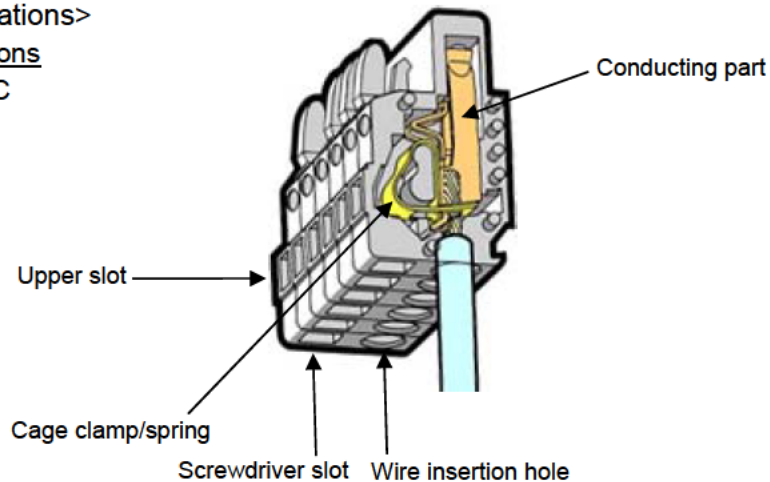

Connecting conditions

- Cable: 0.08 mm² to 2.5 mm²
- Insulation stripped length: 8 mm to 9 mm
- Connecting tool: Dedicated operating lever (provided with the product)



⚠ CAUTION

Use the precise specified insulation stripped length when stripping the cable.

If the stripped length is too short and the conducting wire is not correctly clamped, conduction failure and overheating may result.

If the stripped length is too short and the coating of the conducting wire is clamped, conduction failure and overheating may result.

If the stripped length is too long and the conducting wire is exposed, insulation failure and short circuits may result.

Be careful about unbundling the conducting wire. If the wire is unbundled on insertion, insulation failure and overheating may result.



Applicable bar terminal

The following bar terminals may be used:

- Bar terminal (ferrule): Model 216 series (manufactured by WAGO)
- Crimping tool: Model Variocrimp 4 (206-204) (manufactured by WAGO)

⚠ CAUTION

Be sure to use the specified bar terminal model. We do not guarantee performance with bar terminals other than those specified.

<Connecting to terminal plate>

When connecting the cable to the connector, use the dedicated lever or use a flathead screwdriver, as described below.

⚠ CAUTION

Use the correct tools.

As a rule, connect one wire to one wire hole.

If a wire is accidentally inserted into the screwdriver slot, the wire will not contact the conducting part, and conduction failure and overheating may result.

If a wire is accidentally inserted under the spring, the wire will not contact the conducting part, and cause conduction failure and overheating may result.

Press the dedicated operating lever to open the terminal and insert the wire.
(One by one)

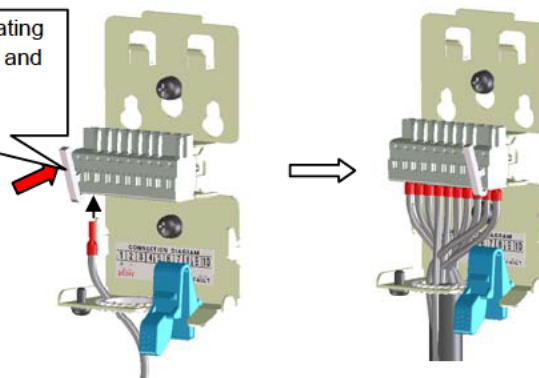

* NOTE

<Using the dedicated operating lever>



Press the lever with your finger to press down the internal spring.



While continuing to press on the lever, insert the wire into the insertion hole (round hole) until the wire strikes the end.
Release the lever to complete the connection.

To confirm that the wire is connected, pull gently on the cable. (Avoid pulling with excessive force.)

<Clamping cable>

Insert the supplied cable tie into the hole of the wall-mounted unit as shown in the figure. Here, arrange so that the rough side faces the cables. After inserting the cable tie, secure the cables together.

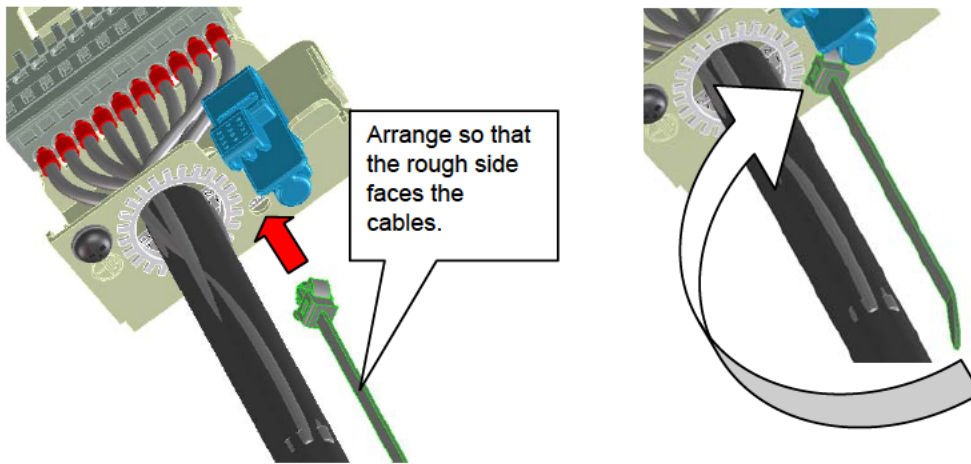

* NOTE

If you use commercially sold cable glands, connect the cable gland to the external wire inlet.



<Grounding>

Connect to the grounding terminal of the product to the grounding terminal provided at your location.

⚠ WARNING

Be sure to ground the detector before turning on power for the product. Be sure to provide grounding. This is required for stable operation and safety of the devices. Never connect the grounding wire to a gas pipe. Use grounding equivalent to Class D grounding (grounding resistance 100 Ω or less).

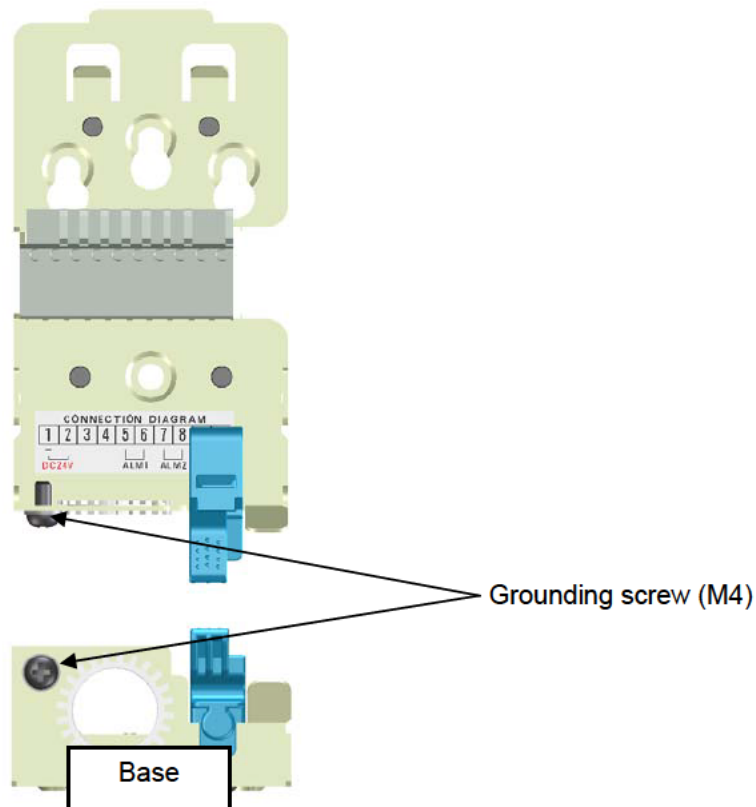

<Connecting and securing LAN cable>

⚠ WARNING

If you connect the LAN cable with the power switch of the gas detector turned ON, data may be transmitted immediately after the connection, affecting system operations in unintended ways. Before connecting the LAN cable, confirm that the power switch of the gas detector is turned OFF. Follow the instructions given by the person in charge of the system when turning ON the power switch of the gas detector.

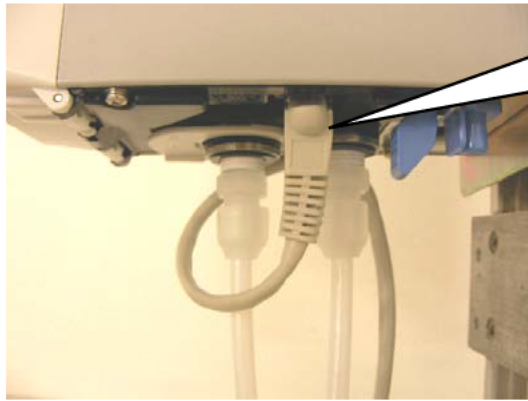

Insert the LAN cable until it clicks into place.

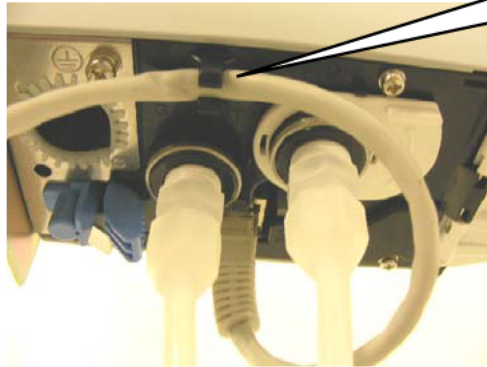

Hold the cable in the hook.

6. Testing and measurement

6-1. Measurement and testing after cabling

Measure and test the LAN cable using a commercially available cable tester.

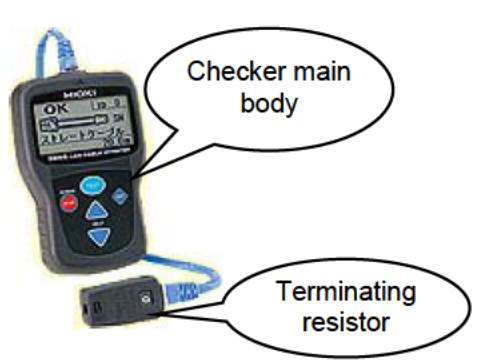
Item	Description
Wire connection	Straight-through connection
Cable failure	No wire breaks or short circuits
Length	80 meters or less
Cable tester (Example for reference)	

6-2. Communication test for entire network

Check to confirm there are no communication failures or noise due to construction and that normal communication is possible when the system operates.

If any malfunctions occur, take appropriate measures based on the symptoms.

7. Maintenance

The communication line plays a significant role in this system with respect to disaster prevention and security.

To maintain performance and improve reliability for disaster prevention and security, regular maintenance is recommended.

7-1. Maintenance intervals and inspection items

Item	Description
Inspecting the LAN cable installation state	The cable must be free from abnormal forces (whether due to tension or heavy objects).
	The cable coating must be free of scratches that affect function.
Inspecting the LAN cable connection	The connector must be free of damage.

7-2. Securing spare parts for emergency response

This gas detector is connected via a communication device (HUB).

It will be subjected frequently to LAN connections and disconnections and similar procedures. If it breaks down due to the damage caused by system construction work, the results for the host system will be significant. To minimize the effects of a failure, we recommend stocking spare parts.

Recommended spare parts

- PoE HUB : If using the PoE system.
- HUB : If using the system with normal HUB communications and separate power supply.

Appendices

The appendices provide lists of check items, tools, and measuring instruments for design and construction.

The lists have been compiled to help you check the validity and prevent problems caused by system construction. Use them effectively.

Appendix 1. Checklist for configuration design

Listed below are check items before construction:

No.	Item	Judgment criteria	Judgment/result
1	Power supply capacity in PoE HUB	The power supply capacity is sufficient even if the maximum number of gas detectors are connected to the ports or the number of connected detectors is restricted by design.	<input type="checkbox"/> OK/ <input type="checkbox"/> NG
2	LAN cable Anti-noise measures	The cable route is isolated from noise sources.	<input type="checkbox"/> OK/ <input type="checkbox"/> NG
3	RJ-45 Modular plug selection	Plugs for stranded wire are not used for solid wire cables. Plugs for solid wire and stranded wire are not used together.	<input type="checkbox"/> OK/ <input type="checkbox"/> NG
4	LAN cable selection	UTP Category 5 or Category 5e	<input type="checkbox"/> OK/ <input type="checkbox"/> NG
5	LAN cable length	80 m or less	<input type="checkbox"/> OK/ <input type="checkbox"/> NG

Appendix 2. System construction checklist

Listed below are the check items after construction.



No.	Item	Judgment criteria	Judgment/result
1	LAN cable Tension	The cable is not pulled tightly but is laid loosely.	<input type="checkbox"/> OK/ <input type="checkbox"/> NG
2	LAN cable Bending	The bending radius is 25 mm or more.	<input type="checkbox"/> OK/ <input type="checkbox"/> NG
3	LAN cable Binding	The cable is not bound tightly by cable ties, etc.	<input type="checkbox"/> OK/ <input type="checkbox"/> NG
4	LAN cable Long distance parallel cabling	The cables are not laid completely in parallel over extended distances.	<input type="checkbox"/> OK/ <input type="checkbox"/> NG
5	LAN cable Isolation from noise sources	The cable is isolated in racks dedicated for communication or by separators.	<input type="checkbox"/> OK/ <input type="checkbox"/> NG
		The cable is kept away from noise sources. [Reference] <ul style="list-style-type: none"> • From transformers and motors: 120 cm or more • From AC power cables: 30 cm or more • From fluorescent lamps: 13 cm or more 	<input type="checkbox"/> OK/ <input type="checkbox"/> NG
6	LAN cable Treatment of excess lengths of cable	When an excess length of cable is rolled in circles, the diameters of the circles are varied.	<input type="checkbox"/> OK/ <input type="checkbox"/> NG
7	LAN cable Unwound portion	On termination, the length unwound is 12.7 mm or less.	<input type="checkbox"/> OK/ <input type="checkbox"/> NG
8	LAN cable Test	Straight-through connection	<input type="checkbox"/> OK/ <input type="checkbox"/> NG
		No wire breaks or short circuits	<input type="checkbox"/> OK/ <input type="checkbox"/> NG
		Each cable is 80 m or less.	<input type="checkbox"/> OK/ <input type="checkbox"/> NG
9	LAN cable Marking	Both ends are marked. Example: Gas detector tag number	<input type="checkbox"/> OK/ <input type="checkbox"/> NG
10	LAN cable Securing	The cables are secured so that they will not come loose even if subjected to a sudden force.	<input type="checkbox"/> OK/ <input type="checkbox"/> NG
11	Grounding	The gas detector case is grounded. (Equivalent to Class D grounding)	<input type="checkbox"/> OK/ <input type="checkbox"/> NG

Appendix 3. Communication failure checklist

Listed below are things to check if you encounter communication problems after the host system is started.

No.	Item	Judgment criteria	Judgment/result
1	No communication	Is the LAN cable correctly connected?	<input type="checkbox"/> OK/ <input type="checkbox"/> NG
		Is the power cable of the HUB disconnected?	<input type="checkbox"/> OK/ <input type="checkbox"/> NG
		Is the HUB on?	<input type="checkbox"/> OK/ <input type="checkbox"/> NG
		Are the address and other parameters set correctly?	<input type="checkbox"/> OK/ <input type="checkbox"/> NG
2	Unstable communication	Is the connector connected securely?	<input type="checkbox"/> OK/ <input type="checkbox"/> NG
		Are there any noise sources near the gas detector?	<input type="checkbox"/> OK/ <input type="checkbox"/> NG
		Are there any noise sources near the cable route?	<input type="checkbox"/> OK/ <input type="checkbox"/> NG
Check also number 1 to number 8 of [Appendix 2. System construction checklist] on the previous page.			<input type="checkbox"/> OK/ <input type="checkbox"/> NG

Appendix 4. List of measuring instruments and tools

Item	Description
Crimping tool	<p>For the terminal plate of the gas detector main unit</p>  <ul style="list-style-type: none"> • Crimping the bar terminals • Manufacturer WAGO • Model Variocrimp 4 (206-204) • Bar terminal (ferrule) Model 216 series
Crimping tool	<p>For LAN cable connector (Reference)</p>  <p>Crimping the RJ-45 modular plug</p>
Cable tester	<p>For LAN cable cabling check (Reference)</p>  <ul style="list-style-type: none"> • Check items • Straight-through connection • Wire breaks and short circuits • Length

Appendix 5. Description of terms

Term	Description
PoE	Power over Ethernet (PoE) refers to power supplied to Ethernet devices over LAN cables. These cables also fulfill Ethernet communication functions.
Crosstalk	Interference Crosstalk can affect communications over a UTP (unshielded twisted pair) cable if the signal on one cable affects a signal on another cable, resulting in contamination with other transmission signals.
Return loss	Loss by reflection The ratio of reflected power to the input power expressed in dB (decibel)

Manual Log

Rev.	Amendment	Issue Data
0	First issue	2018/6/19